

KN-Q7A

Single Band SSB Transceiver Kit Manual

Rev. C
CRKITS.COM
Sep 12, 2012



Written by Adam Rong, BD6CR/4
Edited by Jon Iza, EA2SN

Thanks to the following people for their editing and help.
Shi Ke, BA6BF
Jon Iza, EA2SN
Junichi Nakajima, JL1KRA
Mark McNabb, N7EKU
Qin Ling, BD4AHS

Revision History

Oct 23, 2011: Rev. A, first formal release.

Nov 1, 2011: Rev. A1, modified a typo in step 5. Thanks JG1EAD for pointing out.

Nov 26, 2011: Rev. A2, removed an extra 104 capacitor near microphone input in schematics, and corrected the injected audio amplitude from 5 mV to 1.5 V peak-peak in TX alignment section. Also, changed microphone modulator to DSB modulator in step 3.

Apr 30, 2012: Rev. B, modified the manual to be compatible with both V2.1 and V2.1a PCB, and fixed the description of SET BIAS for final power transistor IRF640.

Sep 12, 2012: Rev. C, [modified the manual to be compatible with both 40m and 20m versions.](#)

Thank you for purchasing your KN-Q7A Single Band SSB Transceiver Kit. The kit was designed specifically for the worldwide market by BA6BF, and kitted and supplied by BD6CR/4. As the upgraded version of the popular KN-Q7 (more than 500 kits were sold worldwide), the KN-Q7A has an improved circuit design and component selection, which makes it an ideal candidate for field operation, back pack and emergency use.

Main Improvements from KN-Q7

- Improved Low Pass Filter (LPF) circuit to meet the -43 dBc standard
- Added post IF amplifier one pole crystal filter to reduce background noise
- Removed RX/ TX indicator LED to further reduce RX current consumption by about 5 mA
- Added an on-board RF attenuator in the front end to eliminate broadcast interference
- Added power polarity protection
- Larger chassis area (+25%) used as heat sink to reduce thermal drift
- More frequency coverage options: support for European calling frequency 7.090 MHz and American calling frequency 7.285 MHz
- Matched IF filter crystals to ensure good selectivity
- Improved part selection, and reduction of SMD part count to just one transistor

Specifications

- Dimension: 153 mm x 97 mm x 40 mm, not including protruding features
- Weight: 500 g or 1.1 lbs
- Power Supply: 12~13.8 V, 3 A
- Current consumption: about 30 mA in RX and about 2 A in TX @ 13.8 V
- RF output: about 10 W PEP @ 13.8 V (5 W PEP for 20m version)
- Spur suppression: better than -43 dBc
- Sensitivity: better than 0.5 μ V at 10 dB SNR
- IF filter: 6 pole crystal ladder filter + 1 pole post IF amplifier crystal filter
- IF bandwidth: about 2.0 kHz
- IF frequency: 8.467 MHz, 8.192 MHz, or 4.194 MHz, depending on the selected tuning range
- Frequency tuning range: about 20 kHz in VXO type. Five options: 7.050~7.070 MHz, 7.080~7.100 MHz, 7.145~7.165 MHz, 7.200~7.220 MHz, 7.280~7.300 MHz or 14.200~14.230 MHz
- Connectors:
 - Speaker output: 3.5 mm connector, mono output
 - Microphone input: 8-pin, can be configured to be compatible with electret microphones
 - Antenna connector: SL-16 type (M or SO-239 type equivalent), rear panel mount
- Controls:
 - IF Gain Control: act as volume control
 - Tune Control
 - On board RF Attenuator trimmer to eliminate broadcast interference

Disclaimer

We offer the kit as is and do not guarantee the assembled kit by yourself can meet your local regulatory requirements, including spurious, environmental or others. As some parts used in the kit are obsolete, we cannot guarantee that all the components in the kit are brand new, but we bear the responsibility of providing them as good as possible.

Tools Preparation

The picture shows the tools needed for the kit building. Besides, you will need an electric drill and a 3 mm drill bit, a 50 Ω , 20 W or higher power dummy load, an HF band SWR/Power meter, a 13.8 V/ 3 A power supply, a personal computer running Windows, an amateur radio transceiver with a general coverage receiver and calibrated frequency display, and other ancillary instruments. It will be nice if you have access to a frequency counter, an audio signal generator, a RF signal generator, an oscilloscope and a spectrum analyzer, but they are not absolutely required.



Parts Inventory

Open the package and read the one-page quick guide thoroughly. By default, the one-page quick guide is the English version, but you might get lucky enough to get a copy in your local language, because some volunteers have translated it for you. To download your local language documents, you can search the CHINA_QRP group file section on Yahoo or go to <http://crkits.com>. There you will find a list of all documents (Thanks EA2SN for Spanish translations and JL1KRA for Japanese translations, and we need more people to contribute to the translation to more languages):

- **Quick Guide:** English, Spanish and Japanese
- **Full Manual:** This manual. English, Spanish and Japanese
- **Part List:** English, Spanish and Japanese
- **Drilling Template:** No text, only drawing

You need to download the complete part list from <http://crkits.com> documents section and do the inventory carefully. The part lists are different for 40m and 20m versions. We have put resistors, trimmers, potentiometers and 104 capacitors into one plastic bag so it will make your work much easier. You may find some extra parts, and it is fine to keep them as backup. It is okay to discard the original metal front panel, rear panel and the original 8x panel screws now, because they have replacements in the kit. If you find problems or missing parts, please contact us by email address on the cover page.

We offer several frequency ranges to meet different requirements:

- **7.050~7.070**, LO 15.536 2pcs, IF 8.467, for Asia, Canada
- **7.080~7.100**, LO 15.570 1pcs (strong pulling capability), IF 8.467, for Europe, Asia, covering the 7.090 calling frequency
- **7.145~7.165**, LO 15.360 2pcs, IF 8.192, for North America, Asia and Europe
- **7.200~7.220**, LO 15.418 1pcs (strong pulling capability), IF 8.192, for North America (General Class)
- **7.280~7.300**, LO 15.500 1pcs, IF 8.192, for North America (General Class), covering the 7.285 calling frequency
- **14.200~14.230**, LO 18.432 1pcs, IF 4.194, for 20m worldwide

For the VXO crystal with strong pulling capability, the VXO range can be pulled much wider, up to 200 kHz by adjusting the VXO coil, but frequency stability gets worse and we don't officially claim support.



Board Assembly

We will do it step by step, finishing one part of assembly at a time, and testing it to ensure final success. In the photo below, we may find several areas marked with a number. That shows the order of the building step. We will also provide partial schematic in each step to help you understand the theory of operation, and make sure you install all the parts required to do the final testing of the block. However, the partial schematic might not contain all the parts you should install in each step, so don't get confused when you are told to install a part not shown on the schematic. Note that PCB version is subject to change without prior notice and it may look slightly different from yours.

Important: For 20m version, please review <http://crkits.com/knq7a20mmod.pdf> first!

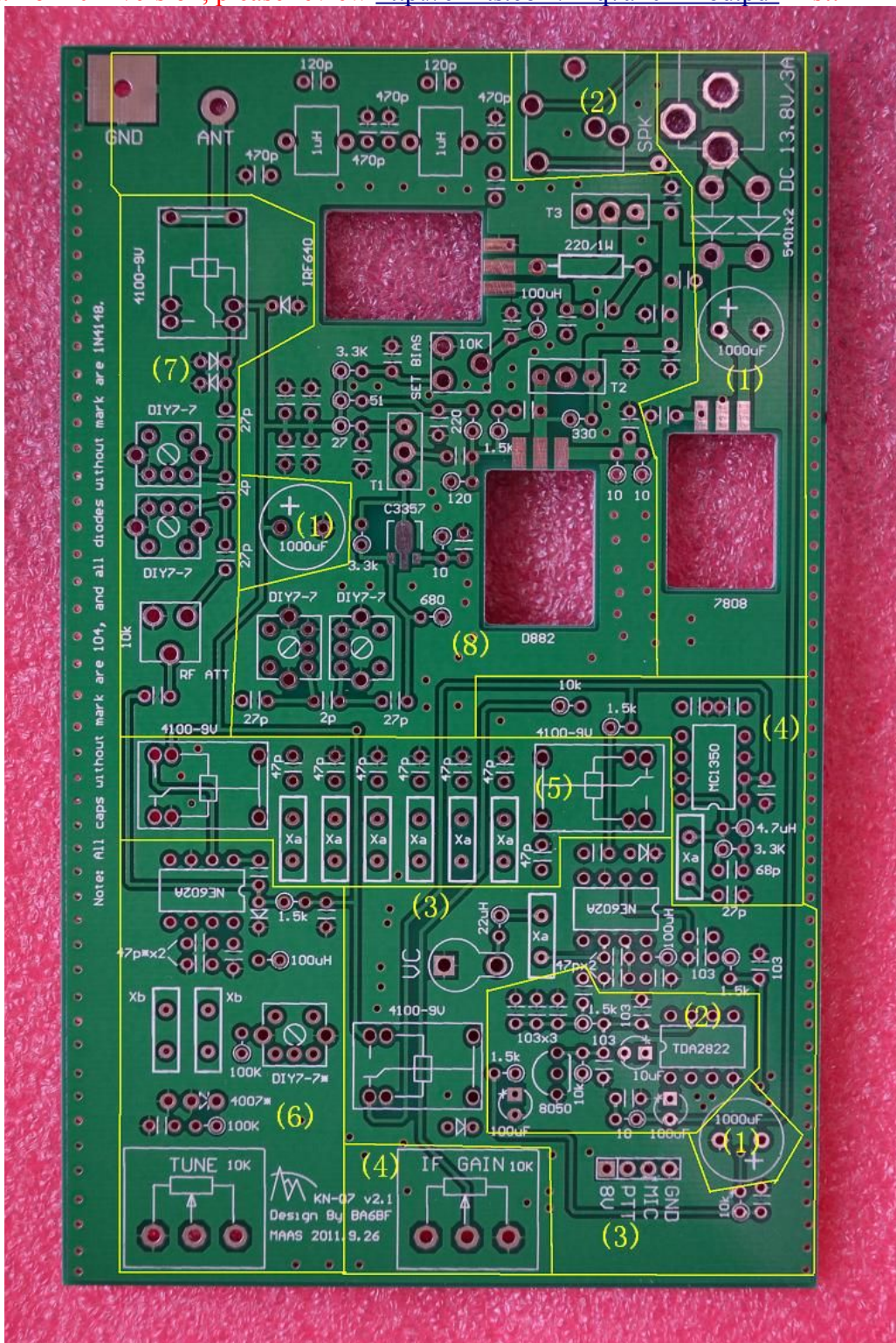

Step 1: Power Supply Circuit

Let's start with the power supply circuit portion. Should you want to study the whole schematic prior to the building to have better understanding, you may find a copy of the circuit at the end of this manual. Please study the partial schematic before soldering.

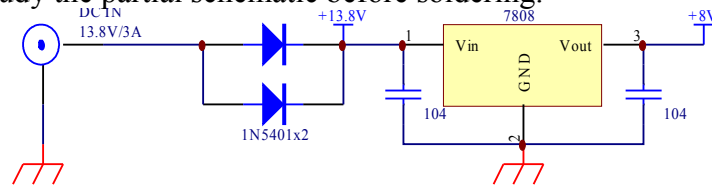

- [] Solder 1x DC IN socket, and trim the pins flush to avoid shorts with chassis foot screws
- [] Bend the pins of 2x 1N5401 diodes as shown, and solder. For other diodes, always bend the pin which is near the bar of the body. Note that from PCB V2.1a, only 1x 1N5401 is required here.

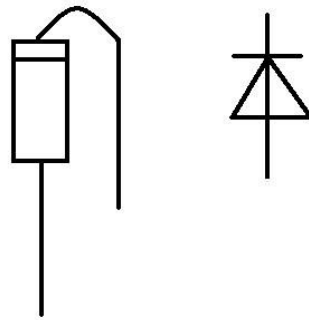

- [] Solder 3x 1000 μF capacitors; check polarity
- [] Solder 1x 0.1 μF (104) ceramic capacitor near 7808. Remember that all capacitors without marking are 104 ones.
- [] Solder 1x 7808 as shown for test purposes

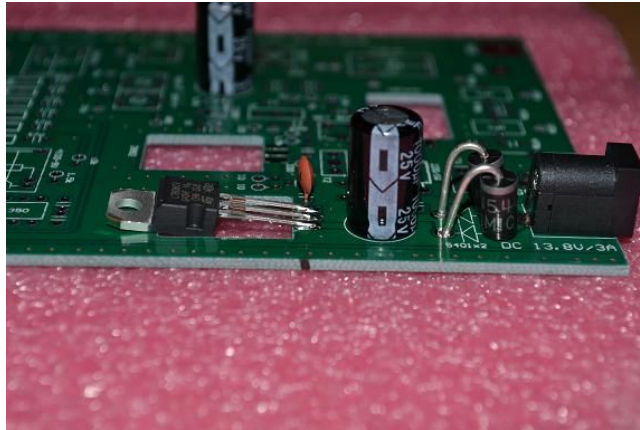

- [] Plug in a 12~13.8 V power supply and measure the voltage on pin 3 of 7808 near to the 104 capacitor to see if it is within +/-5 % of 8 V; if not, check power supply polarity and your soldering
- [] Disconnect the power supply and proceed to the next step.

Step 3: Detector/ Double Sided Band Modulator

The core component is a double-balanced mixer and oscillator NE602A. It acts as the detector in the RX path and also as a DSB modulator in TX. Please study the schematic before soldering. Xa is a marking for IF crystals, whereas Xb is a marking for VXO crystals. **Important: For 20m version, please review <http://crkits.com/knq7a20mmod.pdf> first!**

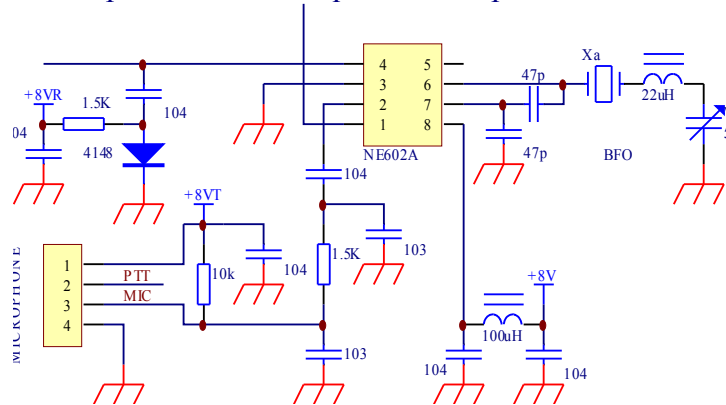

- [] Place 1x NE602A, paying close attention to the notch, and solder
- [] Pick 1x IF crystal 8.467 MHz (or 8.192 MHz or 4.194 MHz if that is the IF of your kit) and solder. You don't have to place an insulator under the crystal or ground the crystal case
- [] Solder 1x trimmer capacitor, and preset it to the max capacity (two layers of plated area overlapping)
- [] Solder 1x SIP4 socket as on-board microphone connector. It is recommended to install as shown on the photo next page so pin definition marking can be seen after the socket is installed
- [] Solder 1x 10 k Ω resistor just below the 1000 μ F capacitor. After soldering, please don't trim the upper pin, as it will be bent and connected to the MIC pin on the SIP4 socket from the solder layer as a jumper wire, as shown (only required for PCB V2.1, and no longer required from PCB V2.1a). It is important to install it as low as possible not to exceed the height of the SIP4 connector pins

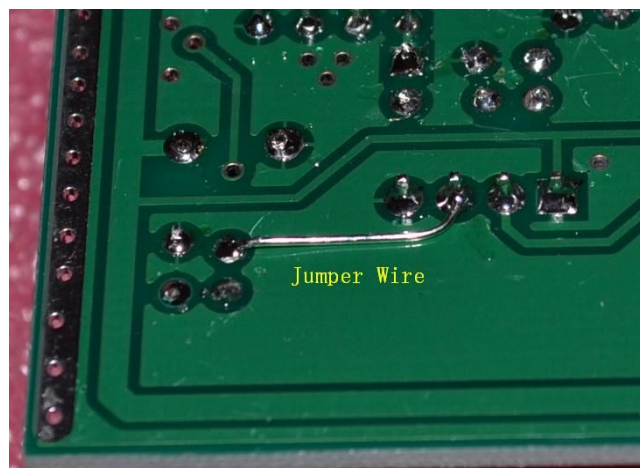

- [] Solder 1x relay. This relay is controlled by the PTT and switches 8 V RX/ TX power
- [] Solder 1x 1N4148 near the relay. Remember that all diodes without marking are 1N4148 and bend the pin near the bar marking on the body

[] Solder the remaining inductors, resistors, diodes and capacitors. When finished, it will look like the photo below. **Important: For 20m version, please review <http://crkits.com/knq7a20mmod.pdf> first!**

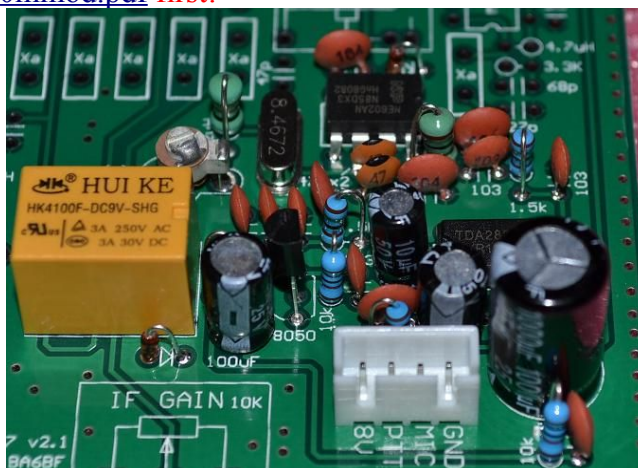

[] Plug in a 12~13.8 V power supply. Short the PTT pin to GND to see if the relay works. Use a nearby general coverage SSB/CW receiver to hear the leakage of the BFO near 8.465 MHz. Connect an external speaker to the speaker connector and touch pin 1 of the NE602A using tweezers to note if the noise coming out of the speaker increases. Check your soldering and the presence of 8 V on pin 8 of NE602A if it is not normal. If all is okay, disconnect the power supply and the external speaker to proceed to the next step.

Step 4: RX IF Amplifier

The core component is an MC1350. There is no AGC circuit designed, and the IF gain is controlled by a potentiometer (IF GAIN) and also used as volume control. A crystal filter is added after the output network of the MC1350. Please study the schematic before soldering. Xa is a marking for IF crystals, whereas Xb is a marking for VXO crystals. **Important: For 20m version, please review <http://crkits.com/knq7a20mmod.pdf> first!**

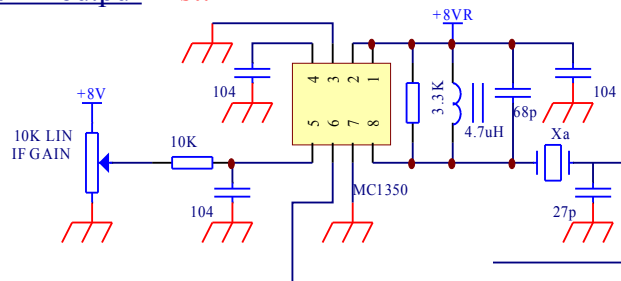

- [] Place 1x MC1350, paying close attention to the notch, and solder
- [] Pick 1x IF crystal and solder. You don't have to place an insulator under the crystal or ground the crystal case
- [] Pick the potentiometer marked B10K and solder it as IF GAIN control, making sure that the shaft is vertical to the PCB side
- [] Solder the remaining inductors, resistors and capacitors. When finished, it will look like the photo below. Note that from PCB V2.1a, a resistor of 1.5k is added between pin 4 and pin 6 of MC1350 to improve receiver audio fidelity. It is not shown in the schematic or the pictures here, but should be easily found on your PCB. **Important: For 20m version, please review <http://crkits.com/knq7a20mmod.pdf> first!**



- [] Plug in a 12~13.8 V power supply and connect an external speaker to the speaker connector. Turn the potentiometer to fully clockwise, touch pin 6 of MC1350 using tweezers and note if the noise coming out of the speaker increases. Turn the potentiometer counter clockwise to note if the noise decreases. If it is not normal, please check your soldering, and check the pin 1, 2 and 8 of the MC1350 for the presence of 8 V. If all is okay, turn the potentiometer fully clockwise again, and disconnect the power supply and the external speaker to proceed to the next step.

Step 5: IF Crystal Filter

This part includes 6x IF crystals, 7x capacitors and 2x relays. Please study the schematic before soldering. Xa is a marking for IF crystals, whereas Xb is a marking for VXO crystals. **Important:** For 20m version, please review <http://crkits.com/knq7a20mmod.pdf> first!

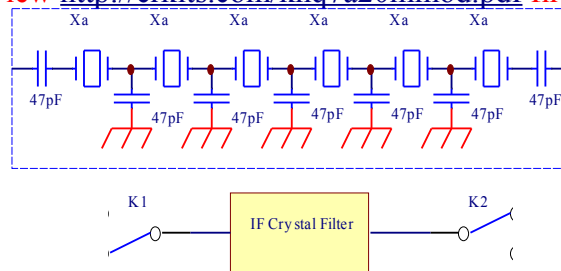

- [] Pick 6x IF crystals and solder. You don't need to place insulators under the crystals or ground the crystal cases
- [] Solder 7x 47 pF capacitors, for 20m version, they are 7x 27 pF
- [] Solder 2x relays. When finished, it will look like the photo below



- [] Plug in a 12~13.8 V power supply and connect an external speaker to the speaker connector. Touch pin 5 of the uninstalled NE602A using tweezers to note a little noise from the speaker. If it is not normal, please check your soldering. If it is okay, disconnect the power supply and the external speaker to proceed to the next step.

[] Solder the remaining parts. When finished, it will look like the photo below. Note that from PCB V2.1a, a 10k resistor is added between the center pin of potentiometer and ground to help improve the tuning linearity of high end frequency range. It is not shown in the schematic or the pictures here, but should be easily found on your PCB. **Important: For 20m version, please review <http://crkits.com/knq7a20mmod.pdf> first!**



[] Plug in a 12~13.8 V power supply and connect an external speaker to the speaker connector. Touch pin 1 of the NE602A using tweezers or even with an antenna cable tip to note if strong band noise comes out of the speaker. Turn the TUNE control to check if VXO frequency changes thus the noise tone changes. The VXO frequency change can be detected by a general coverage SSB/CW receiver nearby. Check soldering and the presence of 8 V on pin 8 of the NE602A if it is not normal. If all is okay, disconnect the power supply and the external speaker to proceed to the next step.

Step 7: RX Front End

This part of circuit includes an antenna select relay, two 1N4148 diodes as a level limiter for protection purposes, two DIY7-7 IFT's (or DIY7-14 for 20m version) as RX band-pass filters (BPF) and a RF attenuator trimmer. By completing this step, you will have a fully working receiver, so you will be able to align it and hear some signals. Please study the schematic before soldering.

Important: For 20m version, please review <http://crkits.com/knq7a20mmod.pdf> first!

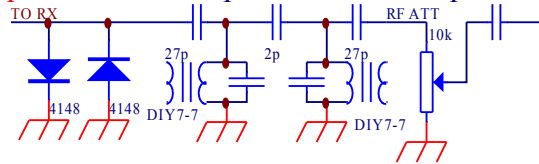

- [] Solder 1x 10 k Ω trimmer, and preset it fully counter clockwise as minimal attenuation
- [] Solder 2x IFT's DIY7-7 (or DIY7-14 for 20m version); no rework is required
- [] Solder 3x 1N4148 diodes; check polarity
- [] Solder 1x relay
- [] Solder the remaining capacitors. When finished, it will look like the photo below. **Important:** For 20m version, please review <http://crkits.com/knq7a20mmod.pdf> first!

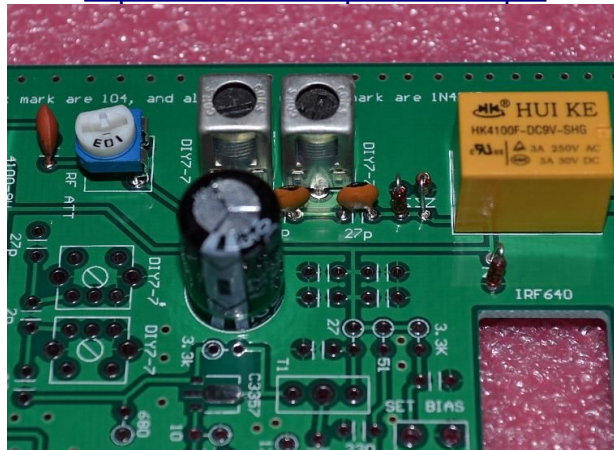

- [] And it also completes the RX part. The full board will look like the photo below



[] Now let's do a brief alignment and enjoy receiving on-air signals. Plug in a 12~13.8V power supply and connect an external speaker to the speaker connector. Touch ANT pin using an antenna cable tip to note strong band noises or signals coming out of the speaker. Turn the TUNE control slowly to see if you can hear any on-going QSO. If not, you may need to turn down the core of the IFT near VXO crystal to extend the tuning range. While hearing the band noise or a QSO signal, peak the RX BPF by turning the cores of the two IFT's. Fine tune the signal by slowly turning TUNE control and if you feel the audio spectrum is not normal and you can only hear vague voices, you may need to turn trimmer capacitor marked VC to change the BFO frequency a little bit until you can hear loud and clear signals from the speaker. Check your soldering if it is not normal. If all is okay, disconnect the power supply and the external speaker to proceed to the next step.

Step 8: TX Amplifiers and Low-Pass Filters (LPF)

This part of the circuit includes a BPF composed of two DIY7-7 IFT's (or two DIY7-14 for 20m version), three amplifier stages using a C3357, a D882 and an IRF640 (or IRF530 for 20m version) respectively, and a two stage LPF. Please study the schematic before soldering. **Important: For 20m version, please review <http://crkits.com/knq7a20mmod.pdf> first!**

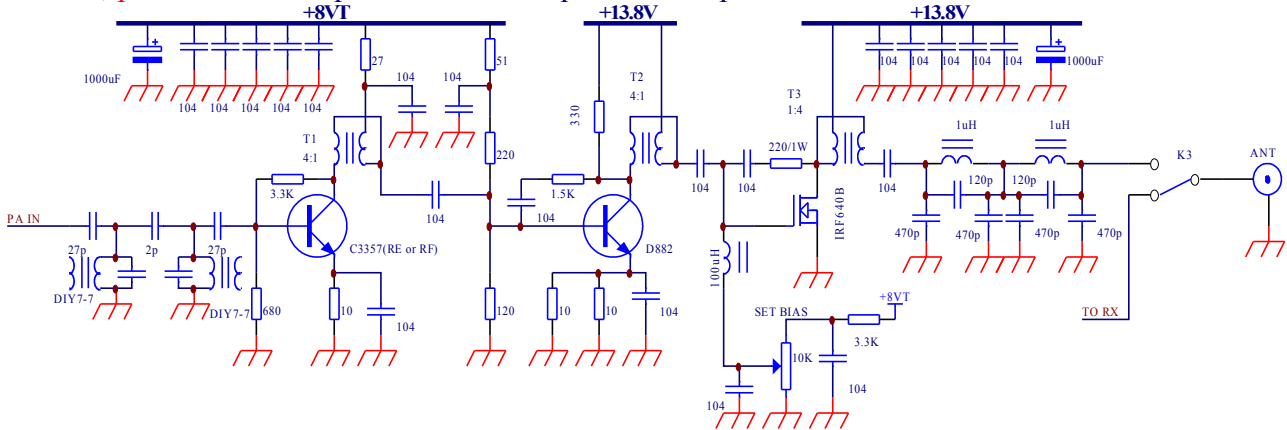

- [] Solder the SMD transistor C3357 first. It comes with an RE or RF marking on the body
- [] Solder 2x DIY7-7 IFT's (or 2x DIY7-14 for 20m version), no rework is required
- [] Solder 1x 10 k Ω trimmer, and preset it to fully counter clockwise to preset 0 V to the gate of IRF640 (or IRF530 for 20m version)
- [] Install the big size 220 Ω 1 W resistor horizontally and solder
- [] Solder the remaining parts, with the exception of all toroid coils, and the D882 and IRF640 (or IRF530 for 20m version) transistors, which will be installed later in final assembly stages. When finished, it will look like the photo below. **Important: For 20m version, please review <http://crkits.com/knq7a20mmod.pdf> first!**

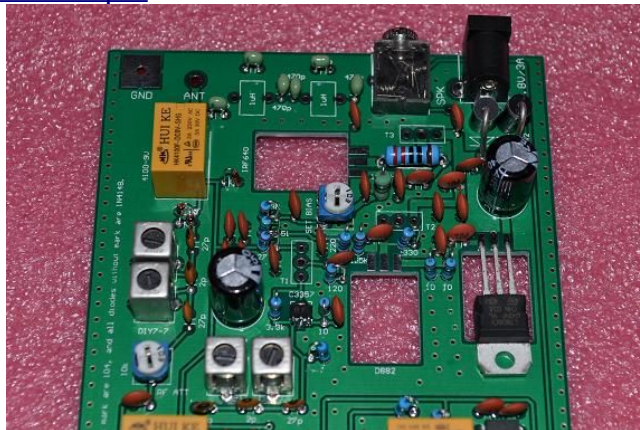

- [] Desolder the 7808 voltage regulator, and clean the solder from the pads and pins

[] We will use two kinds of toroid coils as shown (only one sample each shown). LPF coil (2x) is on the left. It is wound with 12 turns on the larger Chinese NXO-10 toroid using about 25 cm of enamel wire (or you call it magnet wire). From PCB V2.1a, American toroids T37-2 (red) are used here, and should be wound with 15 turns (11 turns for 20m version). The wide-band transformer (3x) is on the right. It requires 5 turns of a bifilar winding on a Chinese NXO-100 (From PCB V2.1a, American toroids FT37-43 (black) are used here, with same winding on NXO-100) toroid using about 20 cm of bifilar enamel wire, and connecting different windings in the middle. The twisting of the bifilar wire is critical with respect to the power output level. Make about 4 twists per inch (25 mm). Once twisted, you should wind 5 turns, and prepare the central tap by connecting two ends from different windings. If the winding start wires are A and B, and the end wires are A' and B', you should join B with A' for the central tap. You will find continuity between A and the central tap, between the central tap and B', and between A and B'. In all cases, you should scrape carefully the enamel from the wire, and tin it prior to use. It is very important to effectively clean the enamel to get good soldered connections. Follow the same procedure to prepare the second LPF coil and the other two wide-band transformers, and solder in place. That ends the board assembly. Let's move on to the final assembly.

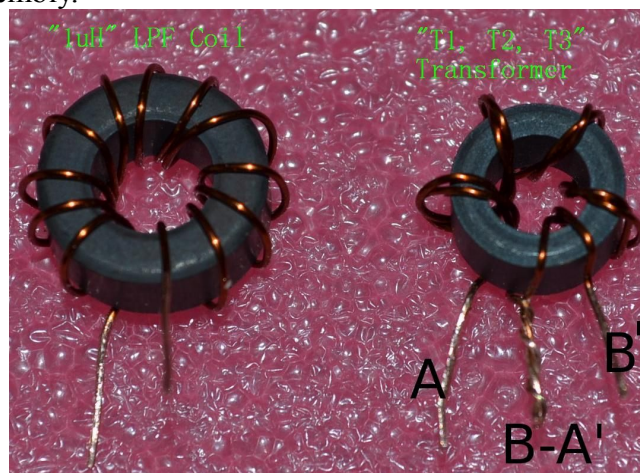

Final Assembly

Now you have the completed board ready to start the final assembly.

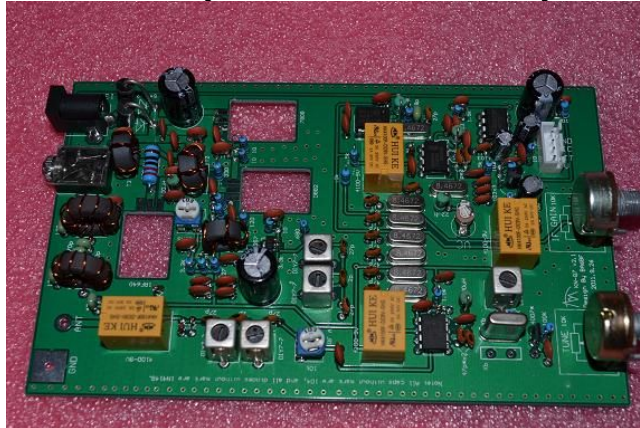

[] You will need to drill 7x M3 holes on any one of the two chassis pieces, since they are identical, but only on one, please :-). Download the drilling template from <http://crkits.com/knq7atemplate.pdf>. Print it on a piece of A4 size paper with 100% scale (the default scale is not necessarily 100%). Cut off the outline and fit it into the chassis bottom.



[] Drill 7x M3 holes. The locations for the 4x chassis feet holes are not very important, but you have to be very careful with the locations of the holes for the three semiconductors. Please pay close attention while you are drilling. After you are done with the drilling, please make sure you remove the blurs from the holes.



[] Install the 4x rubber feet with 4 pairs of M3x10 screws and M3 nuts. The nuts should be placed in the holes of the rubber feet, otherwise the screws will be too long to interfere with the PCB. You can press the rubber feet by your fingers so you can drive screws easily to the nuts and tighten them.



[] Slide in the board through the slot, make sure that you may see the three holes from the rectangular holes on the PCB, and also **observe that there are no short circuit or interference** whatsoever between the board and the chassis. Review carefully the screw head areas.



[] Bend the pins of the 7808, IRF640, and D882 ([IRF530 for 20m version](#)) semiconductors as shown. Please note that IRF640 ([IRF530 for 20m version](#)) is a electrostatic sensitive part, so handle it with care.

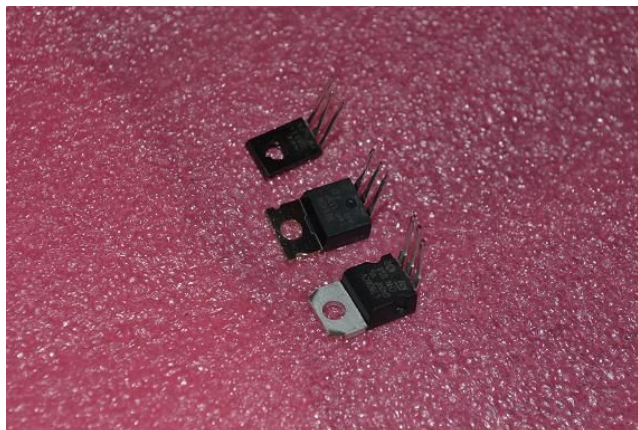

[] Place insulator pads on the places where the body of the D882 and IRF640 ([IRF530 for 20m version](#)) transistors will lie. Place the semiconductors on each position and insert M3x10 screws from the bottom. The 7808 may be secured directly with a M3 nut, as well as the D882 (which already has an insulator pad below). The IRF640 ([IRF530 for 20m version](#)) needs also a small white insulator washer to isolate the metal tab from the chassis. (You may check with a tester that there is no continuity between the screw -or chassis- and the tab). Once all three semiconductors are in position and secured, bend the pins, trim any extra portions and solder.



[] Prepare the rear panel by installing the antenna connector using 4x flat head M3x6 or M3x8 screws and 4x M3 nuts. Remember to add a soldering tab as the ground connection.

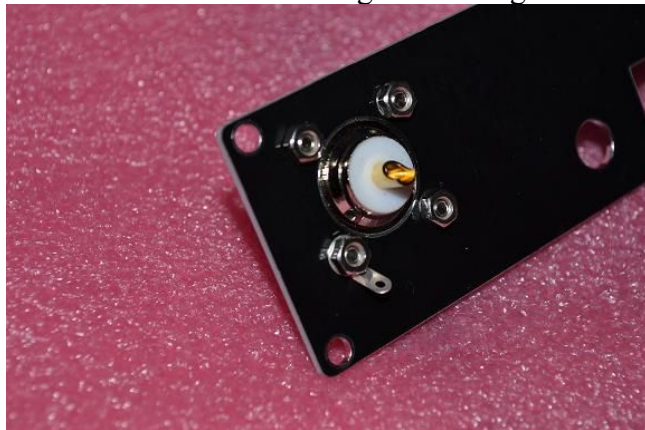

[] Install the rear panel using two black chassis screws and solder the antenna connector.



[] Prepare the front panel by installing the 8-pin microphone connector.



[] Solder the microphone cable, based on the schematic below. This connection is compatible with ICOM HM-series and the supplied optional microphone. To use a different brand microphone, please identify the pinout and wire it accordingly. On the SIP4 connector pin 1 is +8 V, pin 2 is PTT, pin 3 is MIC, and pin 4 is GND. **If you have purchased speaker microphone, you will need to solder a wire from SPK pad on board to the center pin (pin 8) of the microphone connector.**

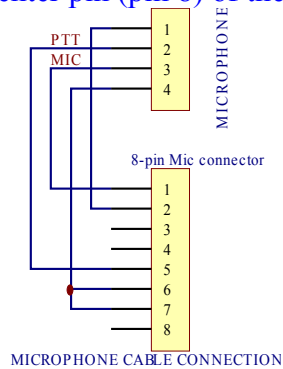

After you are done, the front panel will look like this one.



[] Plug in the microphone cable into the SIP4 socket on board, install the front panel using two black chassis screws, then install the knobs.



[] Preset the IF GAIN control to mid-way and you are ready to start alignment. After alignment, remember to install the top chassis using another 4x black chassis screws.

Alignment

RX Alignment

In previous steps we have done most of the RX alignment. Now we are going to use an audio spectrum analyzer software (on a PC running Windows) to fine tune the BFO frequency, so the RX voice can be very clear, and more importantly, the carrier and the opposite sideband are well suppressed. In the one-page quick guide, we mentioned briefly that we should tune the audio spectrum to lie between 350 Hz and 2200 Hz. Here we provide some details on how to do it easily.

There are many audio spectrum analyzer programs available. Here we recommend for our purpose the free software by Con, ZL2AFP. You may download it from <http://www.qsl.net/zl1an/Software/Spectrum3.zip>. Unzip and double click the spectrum2.exe file to run. The photo below shows the hardware setup. You will need to connect the speaker out to the microphone input of the sound card on PC, as the white audio cable does. You will also need to connect a noise generator or simply an antenna to the antenna connector, and apply a power supply of 12~13.8 V.

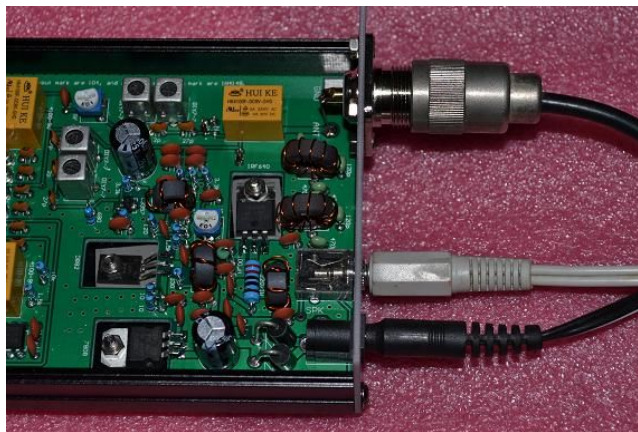

Follow the setup on the screen capture below, and click start, you will see a similar audio spectrum. If not, you may need to turn clockwise or counter clockwise the IF GAIN control. Now fine tune the trimmer capacitor in the BFO to move the pass-band to the left or to the right. You can use the cursor to read the frequency and level of the signal (on the left bottom corner) to identify the low and high end of the pass-band, so you can get about 350 Hz~2200 Hz range. If you have wider or narrower range, please make sure you still set the lower end of 350 Hz. Please note that, if you are using an antenna to do this, you should tune away from any signal to use the band noise as a random noise source, or the spectrum will jump up and down making the measurement very difficult.

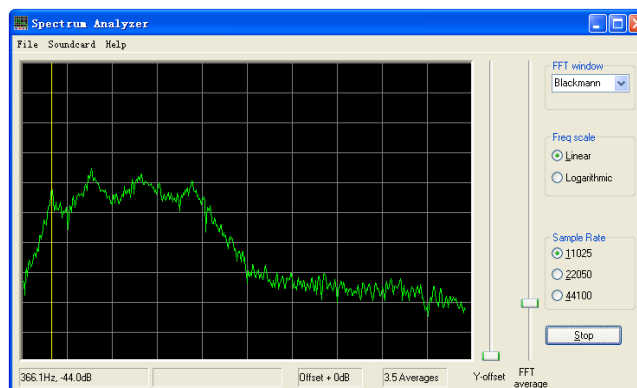

Remove the audio cable and connect an external speaker. Use band noise or a signal to peak again the RX BPF. If you hear strong broadcast interference, especially at night time, you may need to turn the RF ATT trimmer clockwise until the interference is gone. If you attenuate too much, the

signal will be lower too, but you can compensate by turning the IF GAIN up (clockwise).

Then, tune the IFT in the LO to your favorite frequency coverage. Turning it deeper means that you can get a wider frequency coverage range with a lower range end. Normally, the upper end of the range changes a little, but the lower end of the range changes much more. You can use a calibrated radio to receive the same signal and know where you are on the band, or you can use a signal generator to inject a specific frequency so you can get the range that you want quickly.

By the way, you may want to measure the overall current in RX, and it should be about 30 mA. If not, please check your soldering.

TX Alignment

PTT Test: Connect a dummy load to the antenna connector, the power supply of 12~13.8 V/ 3 A to DC IN connector, and a microphone to the front panel connector. Press PTT to see if it causes relay clicks. If not, you should check the wiring of the microphone connector.



Setting bias voltage for the final amplifier IRF640: Make sure that the SET BIAS trimmer is preset to fully counter clockwise first. Connect an ampere meter in series with the power cable (set to measure 1A or more), press PTT but **do not talk to the microphone**, the current will likely be 0.48 A. Then turn SET BIAS trimmer clockwise **SLOWLY** until the current increases 60mA to about 0.54 A. Note that, if you turn the trimmer too quickly, or the preset position is not in the middle, the IRF640 (**IRF530 for 20m version**) might conduct completely and it may cause an over current failure. From PCB V2.1a, a fuse is designed on PCB near 1N5401 diode. Over current failure will most likely blow the PCB fuse, and you can short it with a wire.

Peaking the TX BPF and measuring the RF power output: Connect a power meter between the antenna connector and the dummy load, press PTT while speaking into the microphone loudly, turn the cores of the TX BPF IFT's up a few turns and the RF power output will increase rapidly from about 1 W to about 10 W (**5 W for 20m version**). If you can get 8 W (**4 W for 20m version**) or more peak power, it should be good enough, but if you are serious into getting as much power as possible, you may need to inject a stable audio signal of about 1.0V peak-peak to the microphone input, so you can easily peak the TX BPF to get max power output. EA2SN recommended that you may download a sound card audio generator to do the same job from DL6IAK at <http://dl6iak.etonlein.de/projects/2000-07-01.htm>. Another way to generate stable RF power for peaking TX BPF is to break the balance of BFO NE602A by shorting its pin 2 and pin 3 after PTT is pressed. You may need to adjust capacitor trimmer VC to get a bigger power for TX BPF peaking, but after it, you should adjust the capacitor trimmer back, or the receiver audio will be bad.

Theory of Operation

We have explained the theory of operation in each functional block. Here it may be beneficial to go through the signal flow so it will help to understand the whole schematic diagram below.

The KN-Q7A is a simple design with two NE602A chips which are used both for RX and TX. When in RX, one NE602A works as first mixer plus LO to transform the received RF signal to IF, and the other works as detector plus BFO to transform the IF signal to AF. When in TX, the detector NE602A now works as a DSB modulator to modulate BFO signal with voice and transform it to an IF signal, and the first mixer NE602A still works as a mixer to transform the IF signal to the RF. Some signal switch diodes and relays are used here to multiplex the use of the NE602A chips.

RX signal flow: The RF signal from the antenna is switched by an antenna switch relay, and goes into the RX BPF to filter out the unwanted interference and signals, passes through a variable RF attenuator, goes into the mixer NE602A to transform it to IF signal, then passes through an IF crystal filter, a manually-controlled variable-gain IF amplifier composed of a MC1350, fitted with a post-IF-amplifier crystal filter, and later feeds to the detector NE602A to transform the signal to audio, and finally is amplified by a TDA2822M to drive a speaker.

TX signal flow: The voice picked up by the microphone goes directly into a NE602A to modulate the BFO signal to produce the dual sided-band (DSB) IF signal, then goes through the IF crystal filter to become a single sided-band (SSB) IF signal. It is mixed with the VXO LO to produce the RF signal at the the operating frequency, and after filtering out unwanted mixer products and other signals with the TX BPF, goes into a three-stage TX amplifiers and the LPF which will filter out spurs and harmonics. The antenna selector relay gets the amplified signal to the antenna for transmission.

Schematic Diagram

The schematic is for PCB V2.1 40m. Slight change is possible and will be informed by quick guide.

