

ICOM

INSTRUCTION MANUAL

VHF AIR BAND TRANSCEIVER

IC-A21

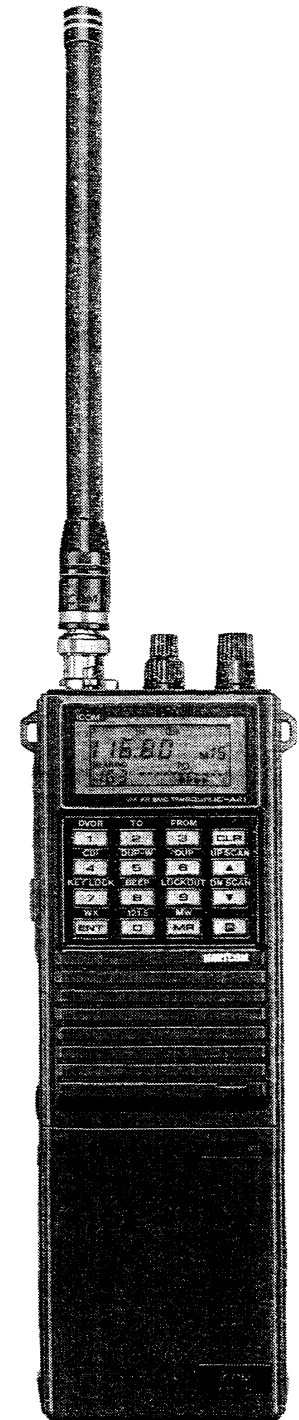

Icom Inc.

IMPORTANT

READ THIS INSTRUCTION MANUAL CAREFULLY before attempting to operate the transceiver.

SAVE THIS INSTRUCTION MANUAL —
This instruction manual contains important safety and operation instructions for the IC-A21.

FOREWORD

Thank you for purchasing the IC-A21 VHF AIR BAND TRANSCEIVER. The IC-A21 is a compact, easy-to-operate handheld with VOR navigation receive capability designed with Icom's state-of-the-art technology.

To fully appreciate the capabilities of your new IC-A21, please read this instruction manual thoroughly before attempting operation. If you have any questions regarding the operation of the IC-A21, feel free to contact your nearest authorized Icom Dealer or Service Center.

CAUTIONS

NEVER connect the transceiver via the [13.8 V DC IN] jack to an AC outlet or to a power source of more than 16 V DC. These connections will ruin the transceiver.

NEVER connect the transceiver to a power source using reverse polarity. This connection will harm internal transceiver circuitry.

NEVER allow children to touch the transceiver.

NEVER use chargers other than those suggested on p. 3.

AVOID using or placing the transceiver in areas with temperatures below -10°C or over $+50^{\circ}\text{C}$.

AVOID placing the transceiver for long periods in direct sunlight.

BE CAREFUL! When transmitting for a long time with high output power, the rear panel may become hot.

UNPACKING

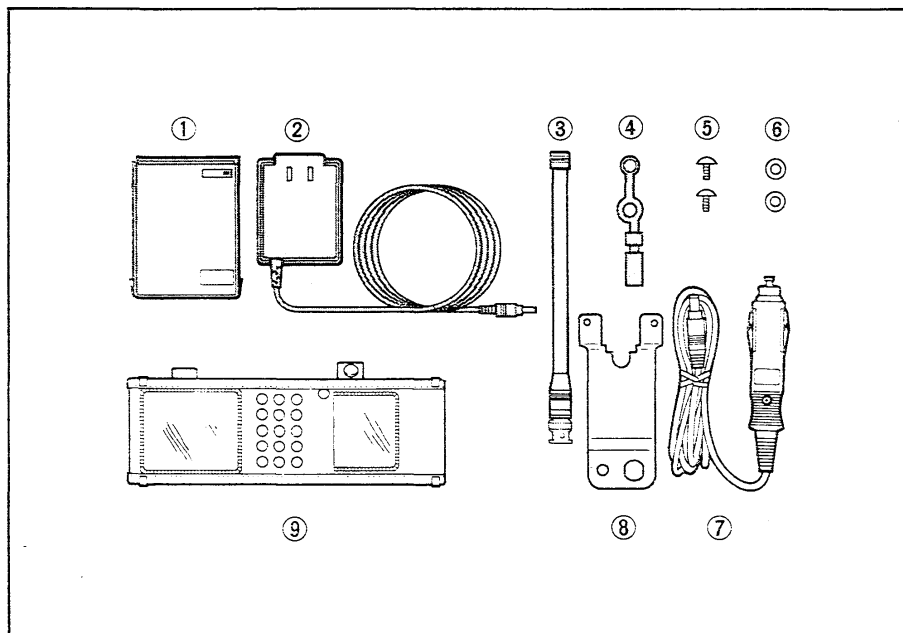

Accessories included with the IC-A21:	QTY.
① CM-7G BATTERY PACK.....	1
② CM-16U/E or CM-17E WALL CHARGER.....	1
③ Flexible antenna.....	1
④ Rubber cap.....	1
⑤ Belt clip mounting screws.....	2
⑥ Belt clip mounting washers.....	2
⑦ CM-1 CIGARETTE LIGHTER CABLE.....	1
⑧ Belt clip.....	1
⑨ LC-74 CARRYING CASE.....	1

TABLE OF CONTENTS

IMPORTANT	i
FOREWORD	i
CAUTIONS.....	i
UNPACKING.....	ii
TABLE OF CONTENTS	ii
1 FEATURES	1
2 ATTACHING ACCESSORIES	2
3 POWER REQUIREMENT	3~4
4 PANEL DESCRIPTION.....	5~10
5 BASIC OPERATION	11~14
6 MEMORY OPERATION	15
7 DUPLEX OPERATION	16
8 SCAN OPERATION.....	17~18
9 VOR NAVIGATION.....	19~24
10 TROUBLESHOOTING.....	25
11 SPECIFICATIONS.....	26
12 OPTIONS.....	27~28

VOR NAVIGATION

The IC-A21 allows you to receive VOR navigation information. In DVOR mode, the IC-A21 displays the bearing to the VOR station. In CDI mode, it shows the deviation from desired course.

CONVENIENT FREQUENCY SELECTION

With the IC-A21 you can immediately select a desired operating frequency by using keyboard entry or rotating the tuning knob.

EXTERNAL DC POWER JACK

The IC-A21 is equipped with an external DC power jack. Operate the transceiver with either the battery pack or an external power source such as a power supply, cigarette lighter socket in a vehicle, etc. No optional DC-DC converter is necessary if you use 12~15 V DC power supply; battery charging can also be performed using this jack.

5 W OUTPUT POWER

With the supplied CM-7G BATTERY PACK, the IC-A21 provides a full 5 W (PEP) of output power. And 1.6 W (PEP) of low output power is selectable.

10 VHF WEATHER CHANNELS

The U.S.A. version has VHF marine weather channel receiving capability for flight planning.

DUPLEX CAPABILITY

The U.S.A. version has duplex capability and allows transmission of a frequency in COM band when receiving a VOR frequency in NAV band. You can call a flight service station while receiving a VOR signal.

20 MEMORY CHANNELS

The transceiver has 20 memory channels with a lock-out function. The U.S.A. version memorizes an independent duplex frequency in each memory channel.

ADDITIONAL FEATURES

- 3 scanning systems: programmed scan, memory scan and weather channel scan*
- Keyboard and function display backlights
- One-touch emergency frequency access capability
- ANL (Automatic Noise Limiter) and AGC (Automatic Gain Control) circuits
- Weatherproof and heavy-duty construction
- A variety of options

*Weather channel: U.S.A. version only

• Antenna and rubber cap

Attach the rubber cap before connecting the antenna to protect the connectors from dust.

Insert the supplied antenna into the antenna connector and twist the connector on the antenna as shown in the diagram below.

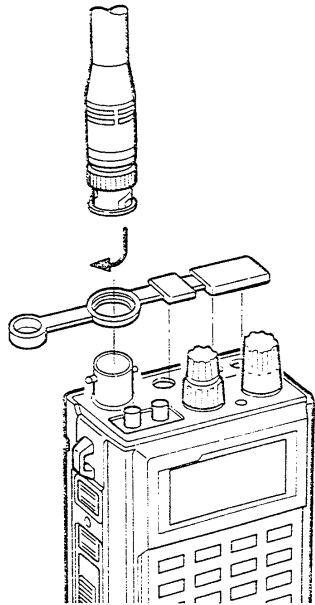

• Belt clip

The belt clip allows you to attach the transceiver to your belt.

Attach the belt clip to the rear panel using the supplied screws and washers.

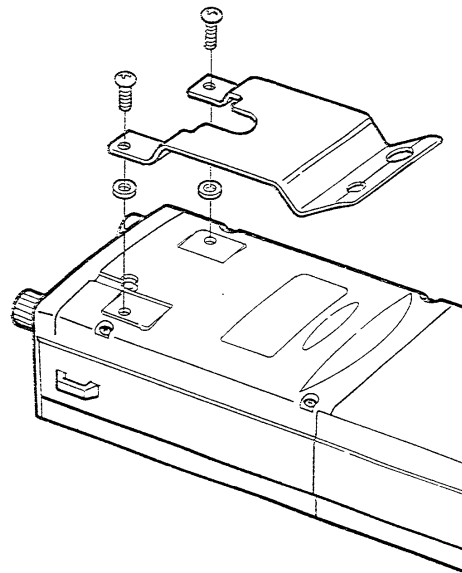

• Battery pack removal

Push the battery pack release button upwards, then slide the battery pack to the right with the transceiver facing you.

To attach the battery pack, mate the notched ends of the transceiver and the battery pack, and slide until a click sound is heard.

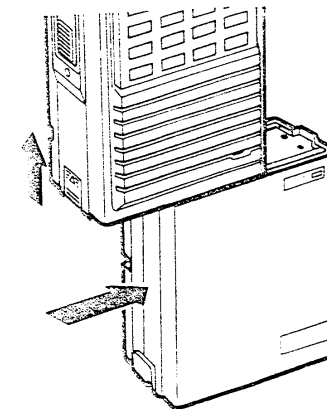

3-1 Charging connection

• Using the supplied wall charger

Connect the supplied wall charger to the [WALL CHARGER] jack on the side of the battery pack.

Turn power
OFF.

to AC outlet
(Receptacle)

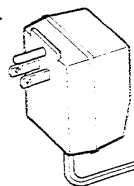

The supplied wall
charger, CM-16U/E
or CM-17E

To use the supplied
CM-1, see Section 3-3.

[CHARGE]
lights up.

Charging time: 15 hrs. (approx.)

• Using an optional CM-35
or CM-60A

Install the battery pack into the
charging slot of the CM-35 or
CM-60A.

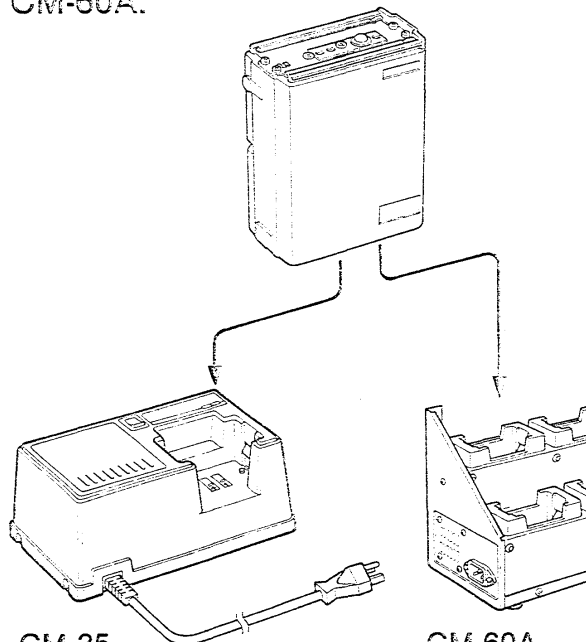

CM-35
AC BATTERY
CHARGER

CM-60A
MULTI-
CHARGER

Charging time: 1.5 hrs. (CM-35)
(approx.) 5 hrs. (CM-60A)

• Optional charger and
cables

Connect to the [DC 13.8 V] jack
on the side of the battery pack.

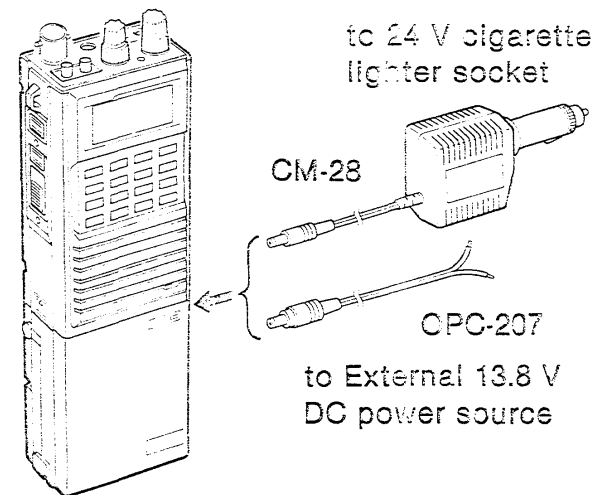

to 24 V cigarette
lighter socket

CM-28

CPC-207

to External 13.8 V
DC power source

Charging time: 15 hrs. (approx.)

3-2 Charging notes

1. **DO NOT** charge a battery pack longer than 30 hours, and **AVOID** completely discharging it. Both of these will shorten the battery's life.
2. **AVOID** charging in extreme cold (under 0°C) or extreme heat (over +40°C).
3. The battery pack to be charged should be nearly fully discharged. Frequent charges of a battery pack that is only partially discharged may not result in a full charge.

• Backup battery

The IC-A21 has a built-in backup battery for retaining memory information. The usual life of the battery is more than 5 years. If the battery is exhausted, the transceiver operates normally but contents in memory channels are not retained when power is turned OFF.

Backup battery replacement **MUST** be done by an authorized Icom Dealer or Service Center.

3-3 External DC power source

The IC-A21 allows operation with a 13.8 V DC power source using an optional cable. Apply 12~15 V DC to the [13.8 V DC IN] jack.

The attached battery pack will be charged while an external power source is connected.

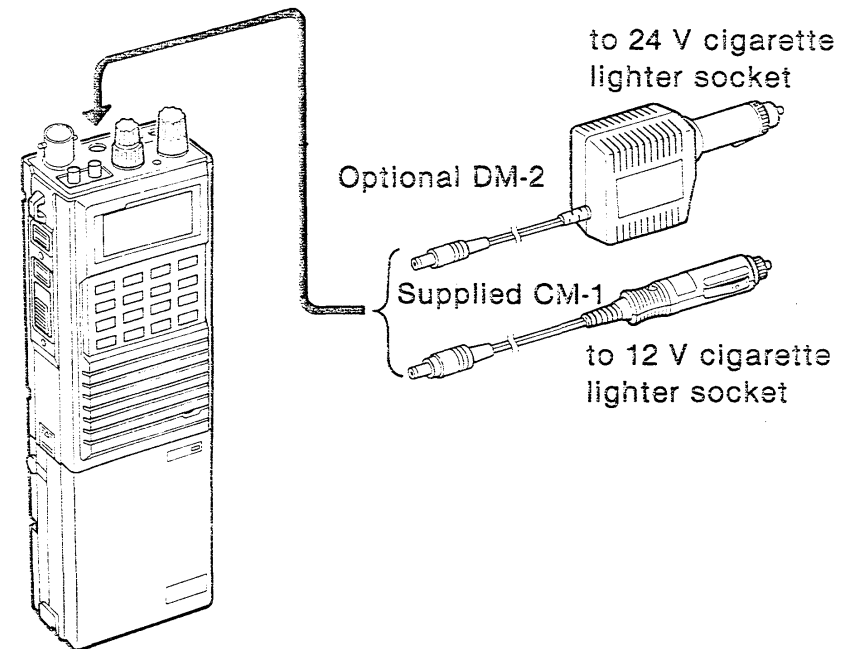

An optional CM-28 cannot be used to operate the IC-A21. The CM-28 is only for charging.

4-1 Switches and controls

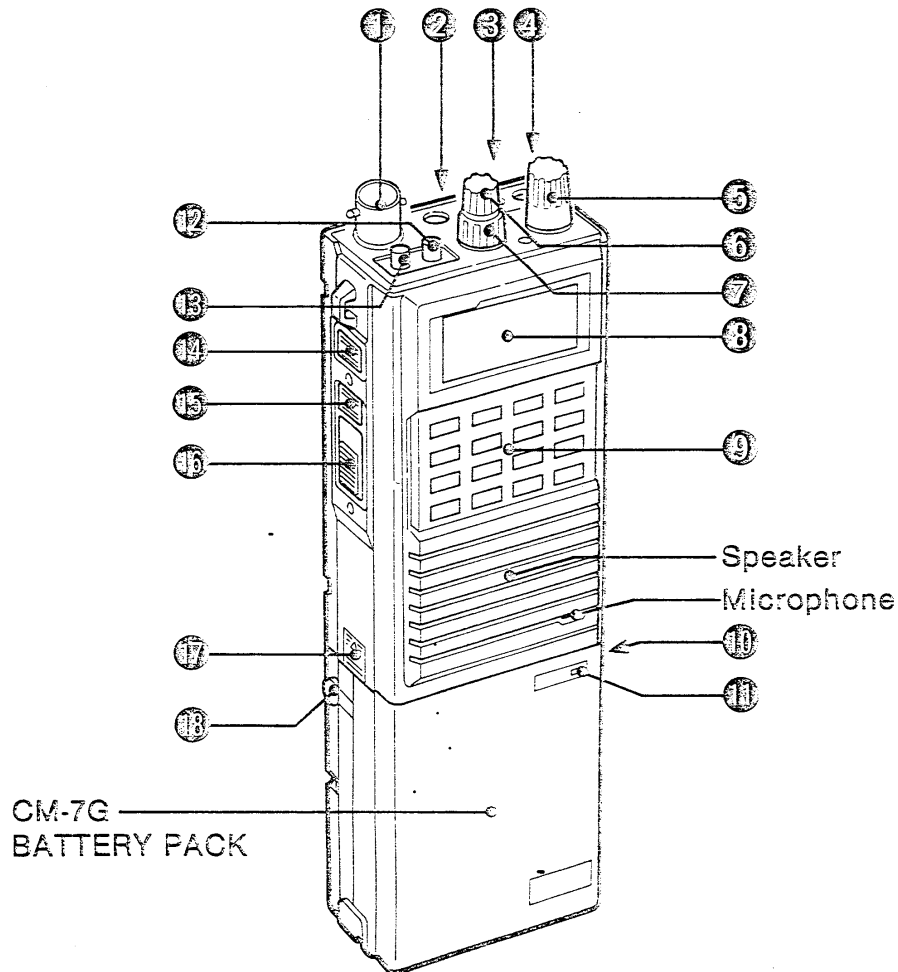

- ① **ANTENNA CONNECTOR** (p. 2)
Connects the supplied flexible antenna.
- ② **EXTERNAL DC POWER JACK [13.8 V DC IN]** (p. 4)
Allows operation with a 13.8 V DC power source using the supplied cigarette lighter cable or the DM-2 DC-DC CONVERTER.
 - The attached battery pack will be charged while an external power source is connected.
- ③ **EXTERNAL MIC JACK [MIC]**
Connects an optional speaker-microphone or headset, if desired.
- ④ **EXTERNAL SPEAKER JACK [SP]**
Connects an earphone or headset, if desired.
 - The internal speaker will not function when either an earphone or headset is connected.
- ⑤ **TUNING KNOB [DIAL]**
Sets an operating frequency (pgs. 11, 12), memory channel (p. 15) or weather channel* (p. 13).
- ⑥ **VOLUME CONTROL [VOL]** (p. 13)
Turns power ON and adjusts the audio level.

*Weather channel: U.S.A. version only

⑦ **SQUELCH CONTROL [SQL]** (p. 13)

Varies the squelch threshold point for audio mute to eliminate noise under no-signal conditions and optimize signal reception.

⑧ **FUNCTION DISPLAY**

Indicates the operating condition. (pgs. 9, 10)

Shows VOR navigation information during DVOR or CDI mode. (pgs. 19, 20)

⑨ **KEYBOARD**

Numerical and other function keys for activating functions and tuning. See pgs. 11 and 12 for tuning operation or pgs. 7 and 8 for a description of functions.

⑩ **DC 13.8 V JACK [DC 13.8 V]** (p. 3)

Allows charging with a 13.8 V DC power source using the supplied cigarette lighter cable or an optional cable.

⑪ **BATTERY CHARGE INDICATOR**

Lights up in red while charging with a wall charger or a charging cable.

⑫ **TRANSMIT POWER SWITCH [HIGH/LOW]**

Selects high or low output power.

⑬ **ANL SWITCH [ANL]** (p. 13)

Activates the automatic noise limiter function.

◦ The function reduces pulse noise such as ignition noise.

⑭ **FUNCTION SWITCH [FUNC]**

Activates the secondary functions of the keyboard and tuning knob.

◦ When no switch is pushed for 3 sec. after pushing [FUNC], the secondary function is canceled.

⑮ **LIGHT SWITCH**

Turns ON and OFF the backlight for the function display and keyboard.

⑯ **PTT SWITCH**

Push and hold to transmit; release to receive.

⑰ **BATTERY PACK RELEASE BUTTON [RELEASE]**

Opens the latch for battery pack removal when pushed upwards.





⑱ **WALL CHARGER JACK [WALL CHARGER]**

Connects the supplied wall charger for charging the CM-7G BATTERY PACK.

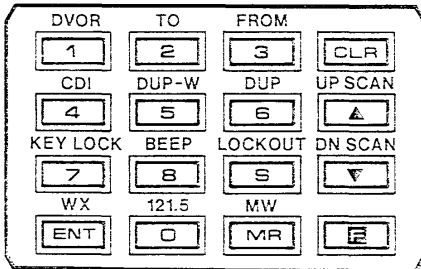
4 PANEL DESCRIPTION

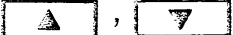
4-2 Keyboard

KEY	FUNCTION	SECONDARY FUNCTION (After pushing [F] or [FUNC])
DVOR 1	 <ul style="list-style-type: none"> ◦ In VFO mode: input the frequency. ◦ In MEMORY mode: input the memory channel numbers. ◦ In CDI mode: input the degrees of the desired course. ◦ While receiving a weather channel*: input the weather channel numbers. 	◦ Enters DVOR mode from CDI mode.
TO 2		◦ Changes the course indicator characteristics to "TO" in DVOR mode.
FROM 3		◦ Changes the course indicator characteristics to "FROM" in DVOR mode.
CDI 4		◦ Enters CDI mode from DVOR mode.
DUP-W 5		◦ Sets the duplex frequency* in NAV band.
DUP 6		◦ Turns ON and OFF the duplex function* in NAV band.
KEY LOCK 7		◦ Turns ON and OFF the keyboard lock function.
BEEP 8		◦ Turns ON and OFF the beep tone.
LOCKOUT 9		◦ Sets the lockout channel for the memory scan.
121.5 0		◦ Selects the 121.5 MHz emergency frequency.

KEY	FUNCTION	SECONDARY FUNCTION (After pushing [F] or [FUNC])
	<ul style="list-style-type: none"> ◦ Switches from MEMORY mode, from the weather channel,* or from the emergency frequency to VFO mode. ◦ Stops scanning. ◦ Clears numerical input. ◦ Clears [FUNC] switch or [F] key input. 	<ul style="list-style-type: none"> ◦ Returns to the previous mode while programming a memory channel or duplex frequency.*
<p>UP SCAN DN SCAN</p> 	<ul style="list-style-type: none"> ◦ Increases or decreases the frequency, memory channel number, and weather channel number.* ◦ Changes the scan direction. 	<ul style="list-style-type: none"> ◦ Starts programmed scan in VFO mode. ◦ Starts memory scan in MEMORY mode.
	<ul style="list-style-type: none"> ◦ Activates the secondary functions in the same way as the [FUNC] switch. 	
<p>MW</p> 	<ul style="list-style-type: none"> ◦ Changes from VFO mode or the weather channel* to MEMORY mode, and vice versa. 	<ul style="list-style-type: none"> ◦ Programs a memory channel and scan edge frequencies in VFO mode. ◦ Transfers memory channel data to VFO in MEMORY mode.
<p>WX</p> 	<ul style="list-style-type: none"> ◦ Enters numerical input. 	<ul style="list-style-type: none"> ◦ Selects a weather channel.*

*Weather channel and duplex function: U.S.A. version only

4 PANEL DESCRIPTION

4-3 Function display

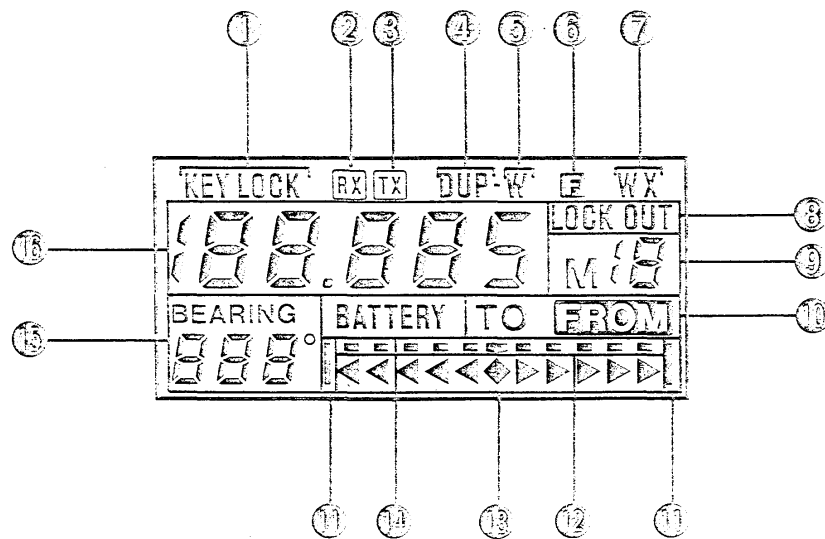

- ① **KEYBOARD LOCK INDICATOR**
Appears when the keyboard lock function is activated.
- ② **RECEIVE INDICATOR**
Appears when the squelch opens.
- ③ **TRANSMIT INDICATOR**
Appears while transmitting.
- ④ **DUPLEX INDICATOR***
“DUP” appears when the duplex function is activated.
- ⑤ **WRITE INDICATOR**
Appears during the following setting or programming condition.
 - “DUP-W” appears while setting a duplex frequency.*
 - “-W” appears while programming a memory channel.
- ⑥ **FUNCTION INDICATOR**
Appears when the [FUNC] switch or [F] key is pushed.
 - The indicator appears for approx. 3 sec. after pushing [FUNC] or [F].

⑦ WEATHER CHANNEL INDICATOR*

Appears when the weather channel is selected.

⑧ LOCKOUT CHANNEL INDICATOR

Appears when the lockout memory channel is selected.

⑨ MEMORY CHANNEL READOUT

Shows the selected memory channel number.

- Only "M" appears when the 121.5 MHz emergency frequency is selected.

⑩ TO-FROM FLAG INDICATORS

Indicates whether the VOR navigation information is based on a course leading to the VOR station or leading away from the VOR station.

⑪ OVERFLOW INDICATOR

Appears if the deviation between the desired course and flying course is over 10 degrees.

⑫ TWO-DEGREE DEVIATION MARKS

Two degrees off course per arrow.

⑬ COURSE DEVIATION NEEDLE

Indicates the deviation between the desired course and your actual flying course every 2 degrees.

⑭ LOW BATTERY INDICATOR

Appears when the connected battery pack requires charging.

⑮ COURSE INDICATOR

In DVOR mode, indicates which radial you are located on.

⑯ FREQUENCY READOUT

Shows the operating frequency or the weather channel.*

- Decimal point blinks during scanning operation.

*Weather channel and duplex function: U.S.A. version only.

5-1 Setting a frequency

(1) Accessing the emergency frequency

The IC-A21 can quickly access the 121.50 MHz emergency frequency. This function can be activated even when the keyboard lock function is turned ON.

- 1) Rotate [VOL] to turn power ON.
- 2) Push [FUNC] on the side panel or [F] on the keyboard.
- 3) Push [0] to recall the emergency frequency.
 - "121.50" and "M" appear on the function display.
- 4) Push [CLR] to exit from the emergency frequency.

(2) Using the keyboard

- 1) Rotate [VOL] to turn power ON.
- 2) Push [CLR] to select VFO mode when "M" or "WX" appears on the function display.
- 3) Push the appropriate digit key to input the frequency.
 - Enter [1] as the 1st digit.
 - When a wrong digit is input, push [CLR] to clear the input.
 - Enter 5 digits; or push [ENT] to enter consecutive zero digits.
 - Only [2], [5], [7], or [0] can be entered as the 5th and final digit.
- 4) To change the frequency according to the tuning step (25 kHz step), push [▲] or [▼].
 - Push and hold [▲] or [▼] to change the frequency quickly.

EXAMPLE: Accessing the 121.50 MHz emergency frequency.

Push keys



Display

123.65

123.65^E

121.50 M

123.65

(3) Using the tuning knob

- 1) Turn power ON and select VFO mode. See steps 1 and 2 at left.
- 2) Rotate the tuning knob to set an operating frequency.
- 3) To select the 1 MHz tuning step, push [FUNC] or [F], then rotate the tuning knob before "F" disappears.

(4) Keyboard lock function

- 1) Push [F], and then [7] to turn ON the keyboard lock function.
 - "KEY LOCK" appears on the function display.
 - Only [PTT] or [LIGHT] can be used.
- 2) Repeat step 1 to turn OFF the function.

EXAMPLE: Setting frequency at 120.00 MHz using the keyboard.

Push keys

1

2

ENT

Display

123.65

1

12

120.00

EXAMPLE: Setting frequency at 126.825 MHz using the keyboard.

Push keys

1

2

6

8

2

Display

120.00

12

1268

126.825

5 BASIC OPERATION

5-2 Receiving

- 1) Set [SQL] to the maximum clockwise position.
- 2) Rotate [VOL] to turn ON power and adjust the audio level.
- 3) Rotate [SQL] counterclockwise until the noise disappears.
 - "RX" on the function display goes off.
- 4) Set the operating frequency using the tuning knob or keyboard.
 - Refer to pgs. 11 and 12 for details.
 - Push [LIGHT] to turn ON the backlight, if desired.
- 5) When receiving a signal on the set frequency:
 - Squelch opens and the transceiver emits audio.
- 6) Push [ANL] IN to reduce pulse noise such as that caused by engine ignition systems, if desired.
- 7) To select a weather channel*:
 - Push [F] and then [ENT].
 - "WX" appears on the function display.
 - Select the desired weather channel.

*Weather channel: U.S.A. version only

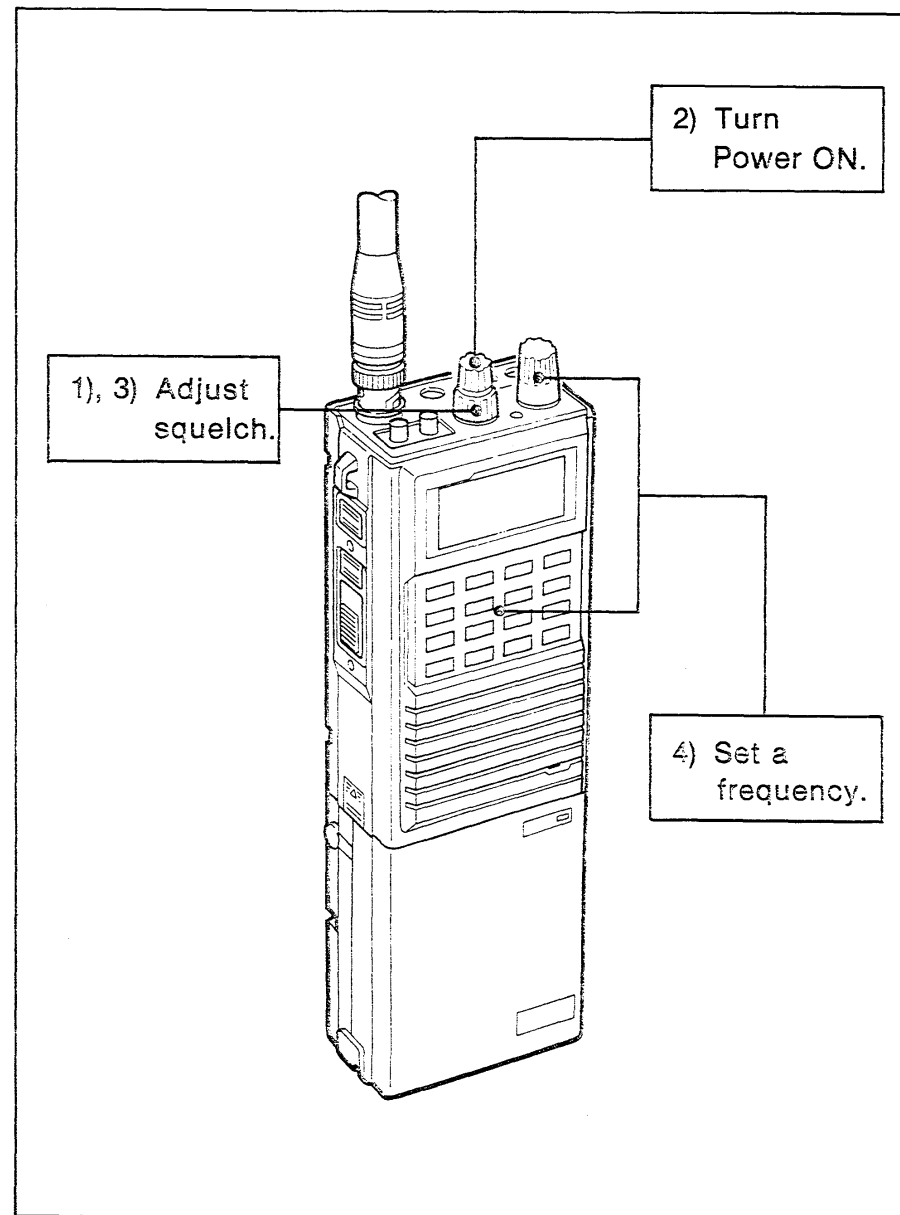

5-3 Transmitting

CAUTION: Transmitting without an antenna may damage the transceiver.

NOTE: To prevent interference, listen on the frequency before transmitting. If the frequency is busy, wait until the channel is clear.

- 1) Set the operating frequency in COM band using the tuning knob or keyboard.
 - COM band frequency range: 118.00~136.975 MHz
 - Refer to pgs. 11 and 12 for details.
- 2) Push [HIGH/LOW] to select the output power.
 - High power: Greater coverage for long distance transmissions.
 - Low power: Conserves the battery's power.
- 3) Push and hold the PTT switch to transmit.
 - "TX" appears on the function display.
- 4) Speak into the microphone at your normal voice level.
 - **DO NOT** hold the transceiver too closely to your mouth or speak too loudly. This may distort the signal.
- 5) Release the PTT switch to receive.

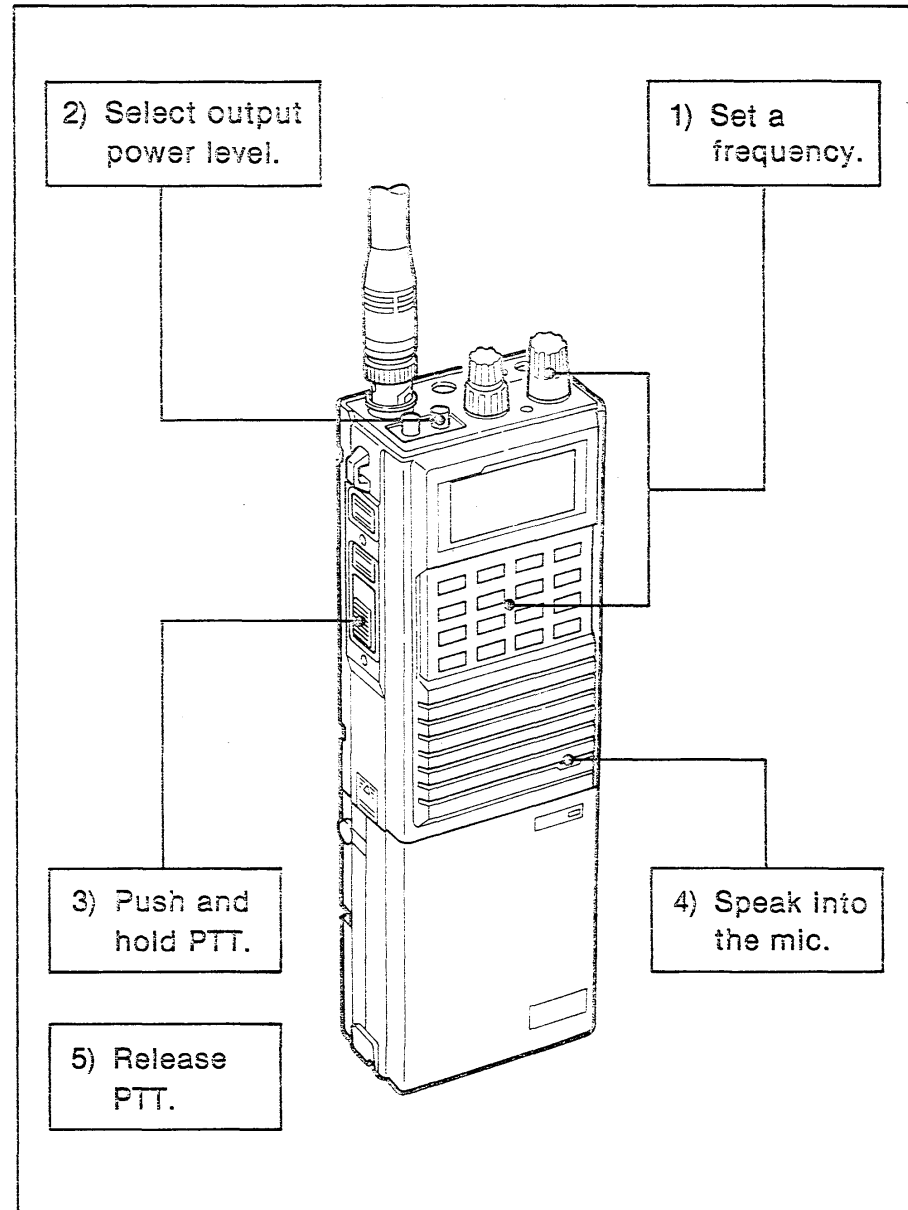

6

MEMORY OPERATION

The transceiver has 20 memory channels. Use memory channels for often-used communication frequencies, VOR stations, etc.

(1) Programming a memory channel

- 1) Select VFO mode or a weather channel.
- 2) Set the frequency (or weather channel) to be programmed into a memory channel.
 - If desired, turn the duplex function ON.
- 3) Push [F] and then [MR].
 - “-W” and memory channel number appears.
 - To cancel this condition, push [F] and then [CLR].
- 4) Select the memory channel using the tuning knob or keyboard; then push [ENT].
 - Memory channel number disappears.

(2) Selecting a memory channel

- 1) Push [MR] to select MEMORY mode.
 - Memory channel number appears on the function display.
- 2) Select the desired memory channel using the tuning knob or keyboard.
 - To select memory channel 0~9 via the keyboard, push [0]~[9] then [ENT] or push [0] then [0]~[9]. “M” blinks on the function display while selecting.
- 3) Push [CLR] or [MR] to return to the previous mode.
 - Memory channel number disappears.

EXAMPLE: Programming 125.00 MHz into memory channel 10.

Push keys



Display

123.65

125.00

125.00^{-W} M17

125.00^{-W} M10

125.00

The duplex function allows you to call a flight service station while receiving a VOR signal. The duplex function requires frequency programming for the flight service station before use.

(1) Programming a duplex frequency

- 1) Push [CLR] to select VFO mode; then select NAV band frequency.
 - NAV band frequency range: 108.00~117.975 MHz.
- 2) Push [F] and then [5].
 - "DUP-W" and transmit frequency appears.
- 3) Set the frequency of the flight service station using the tuning knob or keyboard. When using the knob, push [ENT] after the setting.
 - The displayed frequency returns to NAV band.

(2) Operating the duplex function

- 1) Select the operating frequency in NAV band.
 - NAV band frequency range: 108.00~117.975 MHz.
- 2) Push [F] and then [6] to turn ON the duplex function.
 - "DUP" appears on the function display.
- 3) Push and hold the PTT switch to transmit at the pre-programmed transmit frequency.
- 4) Release the PTT switch to receive.
- 5) Push [F] and then [6] to cancel this function.

EXAMPLE: Programming 121.20 MHz as the transmit frequency in the duplex function.

Push keys

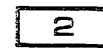
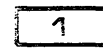
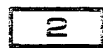
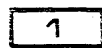

Display

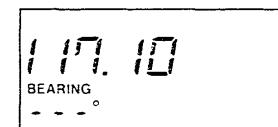
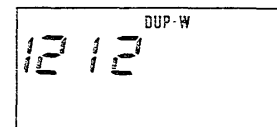
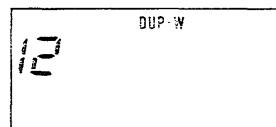
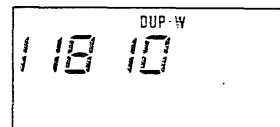
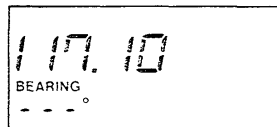

8

SCAN OPERATION

Scan functions search busy frequencies or channels for your convenience. The transceiver is equipped with 3 separate scan functions as follows:

PROGRAMMED SCAN

Repeatedly scans between 2 user-programmed scan edges, memory channels A and B.

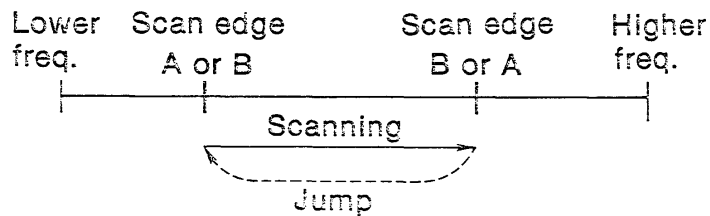

MEMORY SCAN

Repeatedly scans all memory channels except lockout channels.

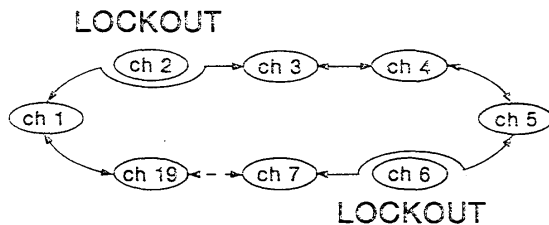

WEATHER CHANNEL SCAN*

Repeatedly scans weather channels.

(1) Operating a scan

- 1) Set the starting condition of the desired scan.
 - For starting the programmed scan, push [CLR] to select VFO mode.
 - For starting the memory scan, push [MR] to select MEMORY mode.
 - For starting the weather channel scan,* push [F] and then [ENT] to select a weather channel.
- 2) Set [SQL] at the threshold point.
- 3) Push [F] and then [▲] or [▼] to start the upwards or downwards scan respectively.
 - The decimal point blinks while scanning.
 - If the transceiver receives a signal, the scan pauses.
 - Push [▲] or [▼], or rotate the tuning knob to change the scan direction or to skip the paused frequency (channel).
- 4) To stop the scan, push [CLR].

*Weather channel: U.S.A. version only

(2) Programming scan edges

Scan edges can be programmed in memory channels A and b which appear only in the memory writing condition between memory channels "19" and "0."

- 1) Push [CLR] to select VFO mode; and then set the desired scan edge frequency in COM band.
- 2) Push [F] and then [MR] to enter the memory writing condition.
 - "W" and memory channel number appear.
 - To cancel this condition, push [F] and then [CLR].
- 3) Rotate the tuning knob to select memory channel "A" or "b."
- 4) Push [ENT] to program the scan edge frequency.
- 5) To program the other scan edge into memory channel "b" or "A," repeat steps 1~4 above.

(3) Lockout channel

Memory channels can be skipped during memory scan. The lockout channel function is only available during memory scan operation.

- 1) Push [MR] to select MEMORY mode.
- 2) Select a memory channel to be locked out.
- 3) Push [F] and then [9].
 - "LOCK OUT" appears on the function display.
 - The lockout channels will be skipped during memory scan operation.
- 4) To cancel "lockout," repeat step 3.

[EXAMPLE]: Programming 125.00 MHz as a scan edge frequency (into memory channel A).

Push keys



Display

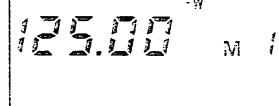
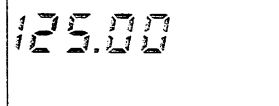
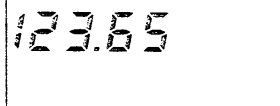

9-1 VOR indicators

NAV BAND (108.00~117.975 MHz)

COM BAND
(118.00~136.975 MHz)

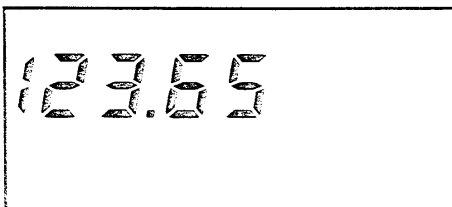

To know your aircraft's location, push [F] and then [1].

To know the deviation between your flying course and the desired course, push [F] and then [4].

To change the flag from "TO" to "FROM" or vice versa, push [F] and then [3] or [2] respectively.

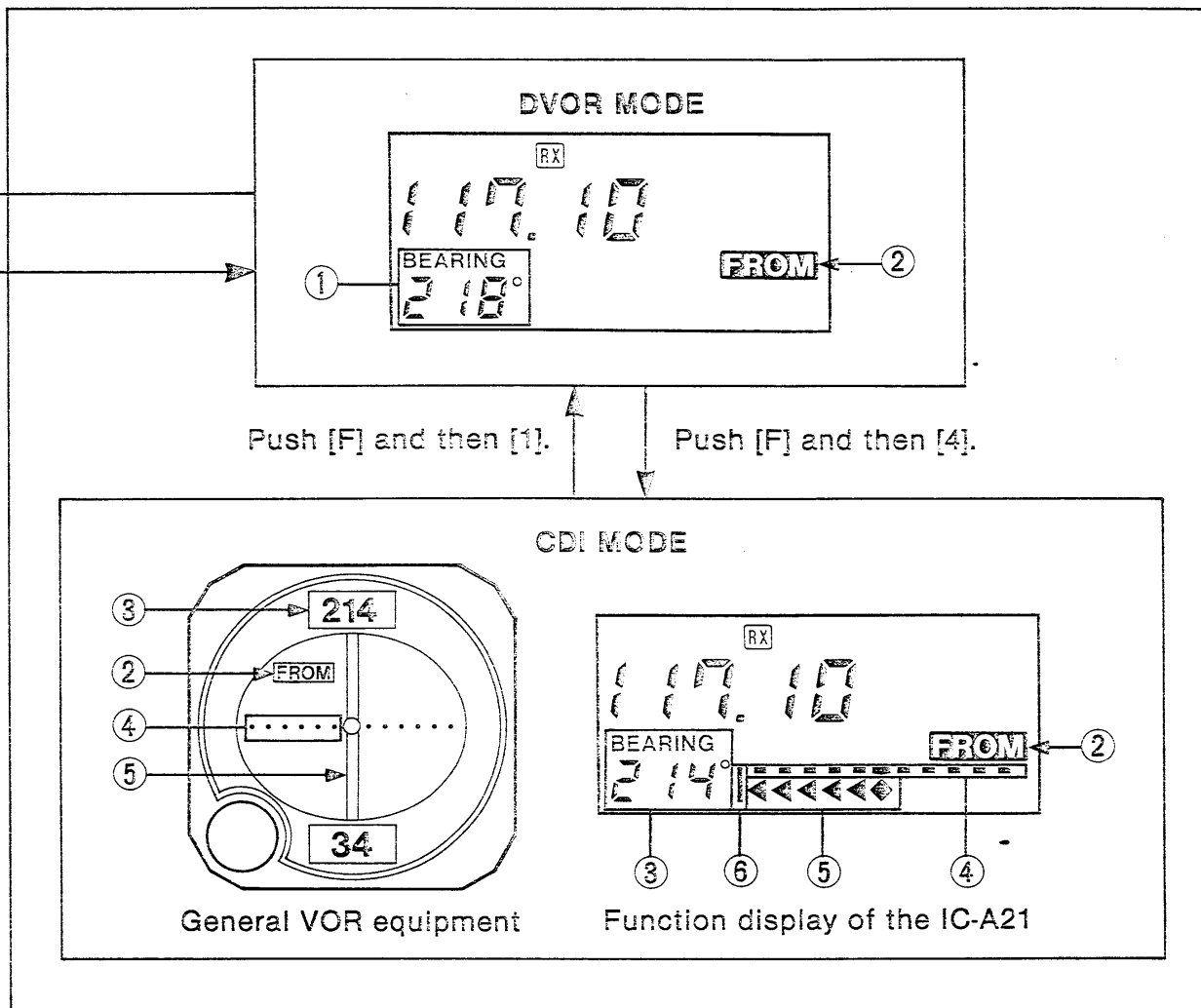

While operating in NAV band, 108~117.975 MHz, the IC-A21 enters DVOR mode automatically. The VOR indicators appear on the function display.

- To select DVOR mode, that is, to know your aircraft's location, push [F] and then [1].
- To select CDI mode, that is, to know the deviation between your flying course and desired course, push [F] and then [4].

① **COURSE INDICATOR (in DVOR mode)**

Indicates where your aircraft is located on a VOR radial in DVOR mode.

- "..." appears when your aircraft is too far from a VOR station or a frequency is not set correctly.

② **TO-FROM FLAG INDICATORS**

Indicate whether the VOR navigation information is based on a course leading to the VOR station or leading away from the VOR station.

③ **COURSE INDICATOR (in CDI mode)**

Indicates where your desired course is located on a VOR radial in CDI mode.

- "OFF" appears when your aircraft is too far from a VOR station or a frequency is not set correctly.

④ **TWO-DEGREE DEVIATION MARKS**

Two degrees off course per arrow.

- Appears in CDI mode.

⑤ **COURSE DEVIATION NEEDLES**

Indicate the deviation between the desired course and your actual flying course every 2 degrees.

- Appears in CDI mode.

⑥ **OVERFLOW INDICATOR**

Appears if the deviation between the desired course and flying course is over 10 degrees.

- Appears in CDI mode.

EXAMPLE: Changing the flag indicator from "TO" to "FROM," or vice versa.

Push keys

Display

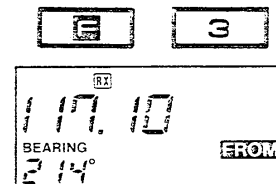
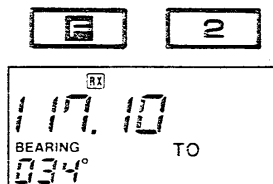
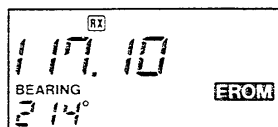

9 VOR NAVIGATION

9-2 Flying to a VOR station

- 1) Select a VOR station on your aeronautical chart and set the frequency of the station.
 - The course indicator indicates where you are located on a VOR radial from the VOR station.
- 2) Select the "TO" flag when flying to the VOR station, or select the "FROM" flag when flying away from the VOR station.
 - To select "TO," push [F] and then [2].
 - To select "FROM," push [F] and then [3].
- 3) Correct your aircraft heading using the course indicator; each arrow represents a two-degree deviation.
- 4) Push [F] and then [4] to enter CDI (Course Deviation Indicator) mode.
 - The course indicator shows "OFF" when either your aircraft is too far away from the VOR station or the frequency is not set correctly at the VOR station.

NOTE: When CDI mode is selected, the operating frequency cannot be changed. To set the operating frequency, select DVOR mode.

- 5) The course deviation needle appears on the function display when your aircraft is off course to the VOR station.
 - "◀" or "▶" appears to indicate your aircraft is off course to the right or left, respectively. Correct your course until "◀" or "▶" disappears.
- 6) To select the DVOR mode, push [F] and then [1].
 - Another VOR station can be selected.

VOR INDICATOR NOTE

"LOC" appears on the function display as shown below when a localizer signal is received.

However, the function display does not indicate additional information about the localizer signal.

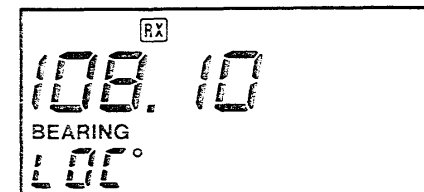

THE AIRCRAFT IS ON COURSE

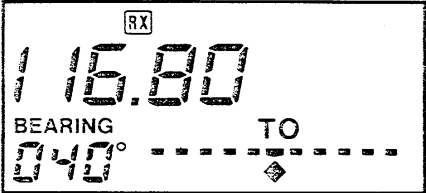

123.65
VORTAC
SEATTLE
116.8 Ch 115 SEA

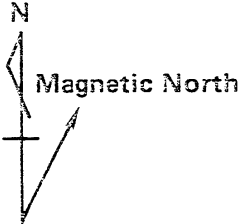
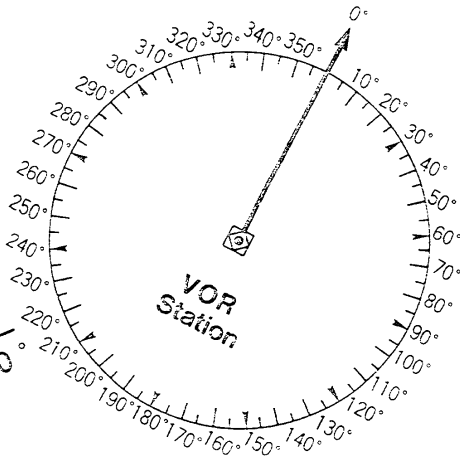
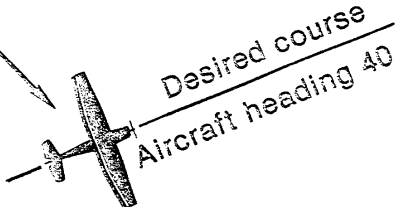

THE AIRCRAFT IS OFF COURSE

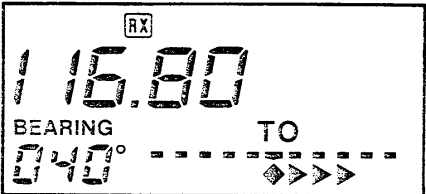

123.65
VORTAC
SEATTLE
116.8 Ch 115 SEA

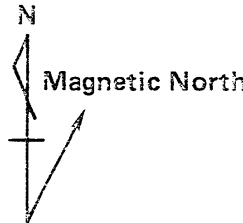
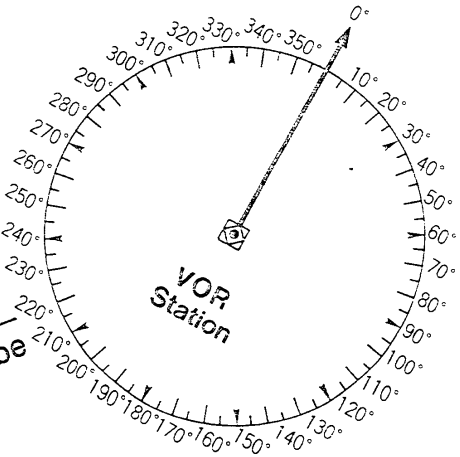
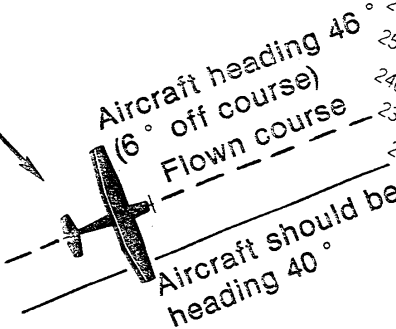

The course deviation indicator appears when the aircraft is off course. In this example the aircraft is 6 degrees left off course. The pilot must turn more than 6 degrees right to get back on course.

9-3 Entering a desired course

The IC-A21 shows not only the deviation from the VOR station but the deviation from the desired course.

- 1) Set the frequency for the desired VOR station.
 - To change the to-from flag, push [F] and then [2] or [3].
- 2) Push [F] and then [4] to enter CDI mode.
- 3) Enter the desired course to the VOR station using the numeral keys or tuning knob.
 - “◀” or “▶” appears on the function display when your aircraft is off the desired course.
 - When your course is actually correct, the ABSS function may be useful instead of course input.
- 4) The course deviation needle points to the right direction when your aircraft is off course to the left.
 - To get back on course, fly right more than the number of degrees indicated by the CDI arrows.
 - If the overflow indicator appears on the right side, select a heading plus 30 degrees to the desired course; if the overflow indicator appears on the left side, select a heading minus 30 degrees.

9-4 Crosschecking position

- 1) Select 2 VOR stations on your aeronautical chart.
- 2) Set the frequency of one of the VOR stations in DVOR mode.
 - The course indicator shows course deviation from the VOR radial. Note the radial you are on.
- 3) Set the frequency of the other VOR station in DVOR mode.
 - Note the radial from the station you are on.
- 4) Extend the radials from each VOR station on the chart. Your aircraft is located at the point where the lines cross.

ABSS FUNCTION

In CDI mode, the Auto Bearing Set System (ABSS) adds to or subtracts from the Omni Bearing Selector (OBSS) the number of degrees indicated by the CDI arrows.

To use ABSS, push [F] then [2] while using TO flag; or, push [F] then [3] while using FROM flag.

EXAMPLE: Entering the desired course bearing 89° to a VOR station.

Push keys



Display

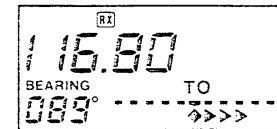
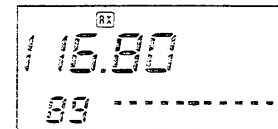
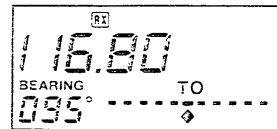
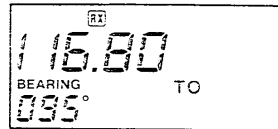
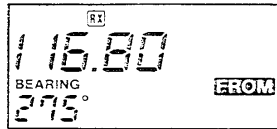

CROSSCHECKING POSITION

VORTAC
OLYMPIA
113.4 Ch 31 OLM

123.85
VORTAC
SEATTLE
116.8 Ch 115 SEA

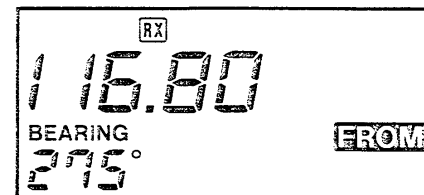
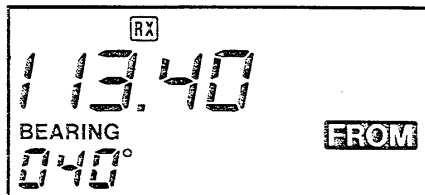
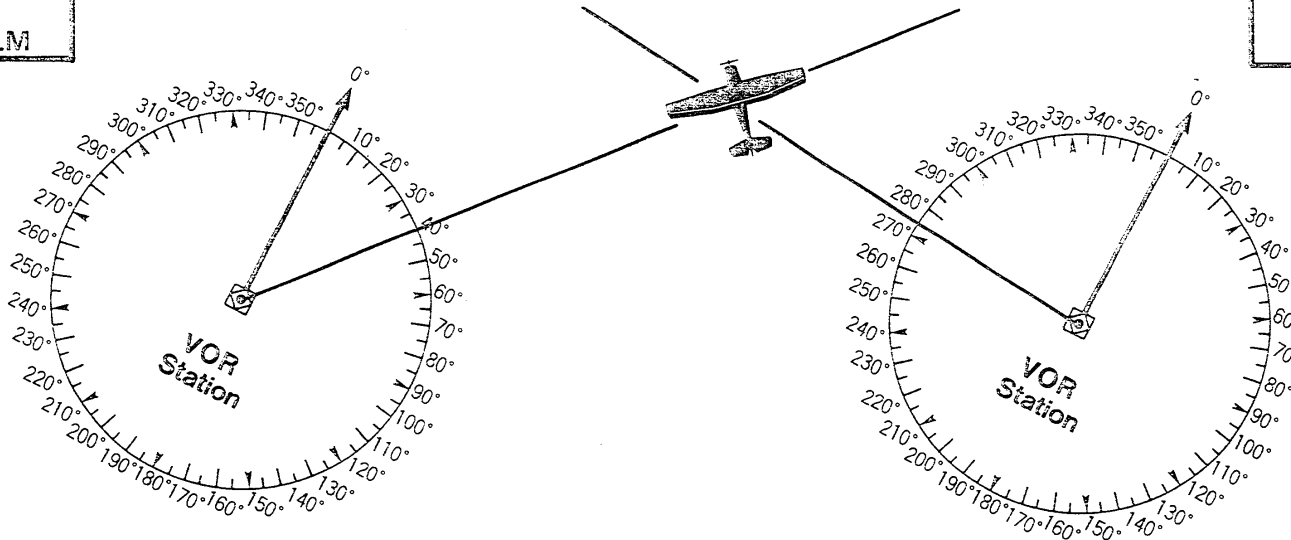

10 TROUBLESHOOTING

PROBLEM	POSSIBLE CAUSE	SOLUTION	REF.
No power comes on.	<ul style="list-style-type: none"> • The battery pack has been discharged. 	<ul style="list-style-type: none"> • Charge the battery pack. 	p. 3
No sounds comes from the speaker.	<ul style="list-style-type: none"> • [SQL] is turned too far counter-clockwise. • The battery pack has been discharged. 	<ul style="list-style-type: none"> • Rotate [SQL] clockwise. • Charge the battery pack. 	p. 13 p. 3
No transmitting possible or only low power can be used.	<ul style="list-style-type: none"> • The battery pack has been discharged. • NAV band or Weather channel is selected. • Low power is selected. 	<ul style="list-style-type: none"> • Charge the battery pack. • Select the COM band frequency. • Select High output power. 	p. 3 p. 14 p. 14
Frequency cannot be set.	<ul style="list-style-type: none"> • The keyboard lock function is activated. • CDI mode is selected. 	<ul style="list-style-type: none"> • Turn OFF the keyboard lock function. • Select DVOR mode. 	p. 12 p. 7
Scan does not operate.	<ul style="list-style-type: none"> • [SQL] is not set correctly. • The keyboard lock function is activated. 	<ul style="list-style-type: none"> • Set [SQL] at the threshold point. • Turn OFF the keyboard lock function. 	p. 13 p. 12

RESETTING THE CPU

When the function display shows erroneous information, the CPU should be reset before sending the transceiver to an Icom Dealer or Service Center.

NOTE: After resetting the CPU, all information you have programmed into memory channels will be erased.

- 1) Turn power OFF.
- 2) While pushing [F] and [CLR], turn power ON.

- 3) Release the switches after the function display shows "118.00."

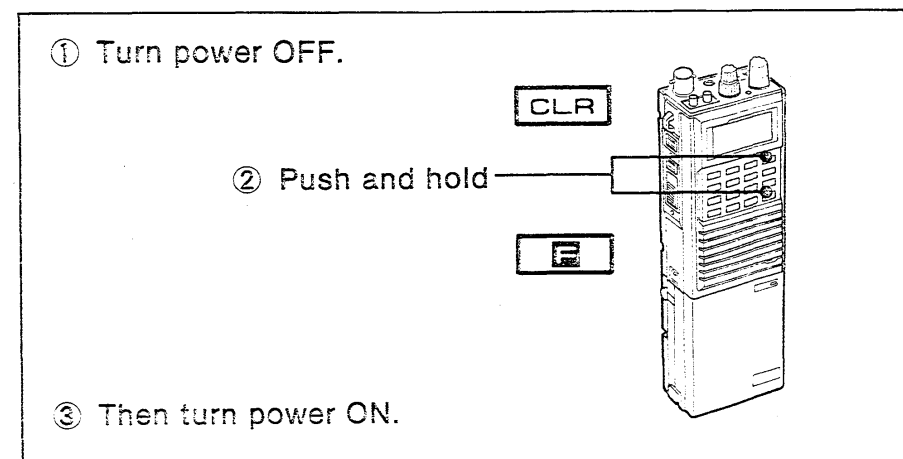

GENERAL

- Frequency coverage :

Transmit	COM band	118.000~136.975 MHz
Receive	NAV band	108.000~117.975 MHz
	COM band	118.000~136.975 MHz
	Weather*	ch. 01~ch. 10

- Tuning step : 25 kHz
- Number of memory channels : 20
- Mode : Transmit/Receive AM (6K00A3E)
Receive FM (16K0G3E)*
- Antenna impedance : 50 Ω (unbalanced)
- Power supply requirement : CM-7G or CM-12G
External 12~15 V DC
(Negative ground)
- Current drain (at 13.2 V DC; typical value) : Transmit
High 900 mA
Low 600 mA
Receive
Max. audio output 400 mA
Squelched 55 mA
- Usable temperature range : $-10^{\circ}\text{C} \sim +50^{\circ}\text{C}$
- Frequency stability : $\pm 0.002\%$
($-10^{\circ}\text{C} \sim +50^{\circ}\text{C}$)
- Dimensions (with CM-7G) : 65(W) \times 198(H) \times 35(D) mm
(projections not included) 2.6(W) \times 7.8(H) \times 1.4(D) in
- Weight (with CM-7G) : 640 g (1.4 lb)

TRANSMITTER

- Output power (at 13.2 V DC) :

	PEP power	Carrier power
High	5.0 W	1.5 W
Low	1.6 W	500 mW

- Modulation system : Low level modulation
- Spurious emissions : -50 dB
- Microphone impedance : 1 k Ω

RECEIVER

- Receive system : Double-conversion
superheterodyne
- Intermediate frequencies : 1st 35.8 MHz
2nd 455 kHz
- Sensitivity : 1.0 μV for 6 dB S/N (with 1 kHz,
30 % modulation)
- Squelch sensitivity (threshold) : 0.25 μV
- Spurious response rejection : -60 dB
- Noise and hum : 25 dB
- Audio output power : 600 mW with an 8 Ω load
- Audio output impedance : 8 Ω

All stated specifications are subject to change without notice or obligation.

*Weather channel and FM mode: U.S.A. version only

12 OPTIONS

CM-9 SPEAKER-MICROPHONE

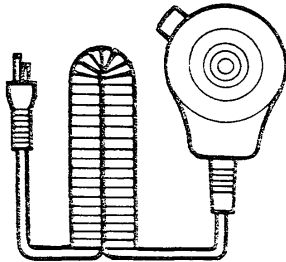

Combination speaker and microphone.

EM-46 SPEAKER-MICROPHONE

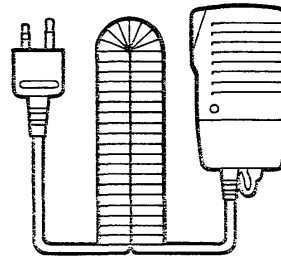

Combination speaker and microphone in a small body. Earphone jack is equipped.

EM-54 SPEAKER-MICROPHONE

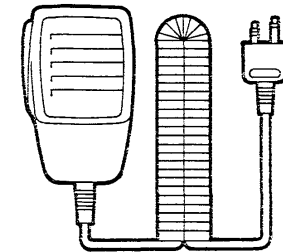

Combination speaker and microphone.

CM-35 AC BATTERY CHARGER

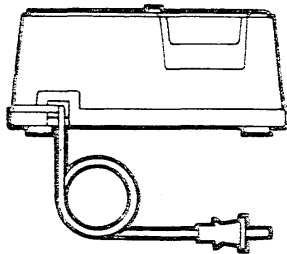

Desktop charger. Rapidly charges the CM-7G within 1.5 hours.

CM-60A MULTI-CHARGER

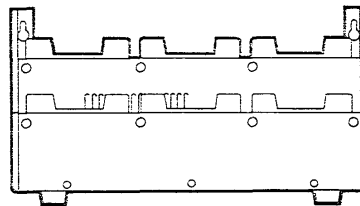

Simultaneously charges up to 6 battery packs within 5 hours.

DM-2 DC-DC CONVERTER

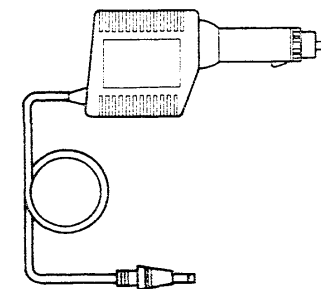

Allows you to operate the IC-A21 through a 24 V cigarette lighter socket.

HS-20SB PTT SWITCHBOX

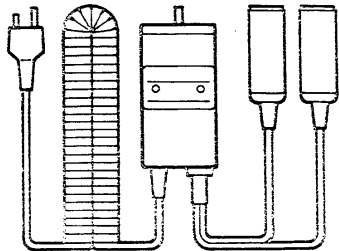

Manual transmit/receive switching unit for non-locom headset and microphone.

ST-10 SHOULDER STRAP

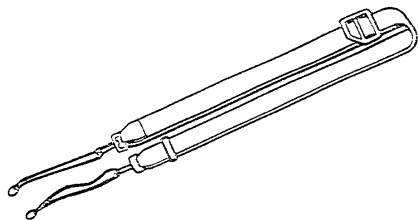

For carrying the IC-A21.

BA-10 BOTTOM CAP

Protective cap for terminals on the base of the IC-A21 when using with an external DC power supply.

CM-1 CIGARETTE LIGHTER CABLE

Allows you to use the IC-A21 through a 12 V cigarette lighter socket. Also charges the CM-7G. Same type as supplied with the IC-A21.

CM-7G BATTERY PACK

13.2 V, 450 mAh NiCd rechargeable battery pack. Same type as supplied with the IC-A21.

CM-12G BATTERY CASE

Battery case for R6 (AA) size x 10.

CM-16U/E, CM-17E WALL CHARGER

Fully charges the CM-7G within 15 hours. Same type as supplied with the IC-A21.

CM-23 DC-DC CONVERTER

For charging the CM-7G through a 24 V cigarette lighter socket.

CP-10 BATTERY SEPARATION CABLE

For separating the IC-A21 from the battery pack.

LC-74 CARRYING CASE

Covers the IC-A21 and its battery pack. Same type as supplied with the IC-A21.

MB-16D WALL BRACKET

For placing the IC-A21 in a convenient location.

OPC-207 DC POWER CABLE

For charging the CM-7G through an external 12~15 V DC power supply.

HAND STRAP

Handy hand strap for complete mobility.

Count on us!

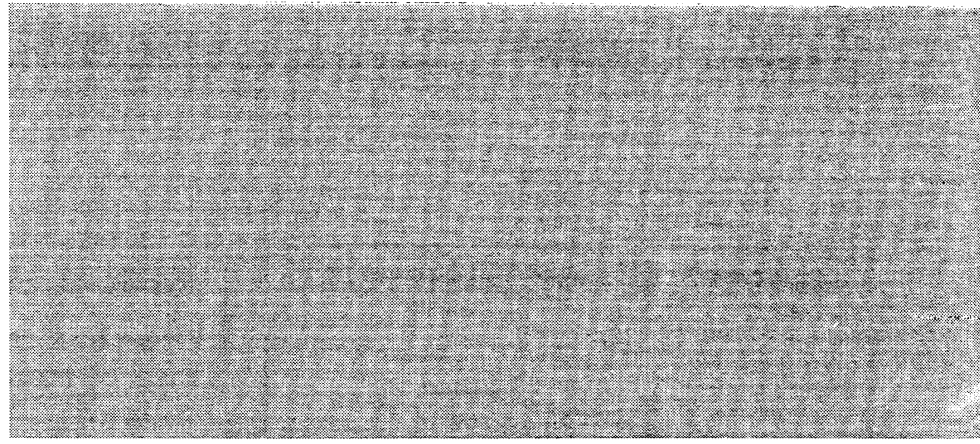

A-5134H-1US-①
Printed in Japan
Copyright © 1990 by Icom Inc.

Icom Inc.
6-9-16, Kamihigashi, Hirano-ku, Osaka 547, Japan