

ICOM

INSTRUCTION MANUAL

VHF/UHF
ALL MODE TRANSCEIVER
IC-821H



Icom Inc.

IMPORTANT

READ THIS INSTRUCTION MANUAL CAREFULLY before attempting to operate the transceiver.

SAVE THIS INSTRUCTION MANUAL. This instruction manual contains important safety and operating instructions for the IC-821H.

PRECAUTIONS

⚠ WARNING HIGH VOLTAGE! NEVER attach an antenna or internal antenna connector during transmission. This may result in an electrical shock or burn.

⚠ NEVER apply AC to the [DC13.8V] socket on the transceiver rear panel. This could cause a fire or ruin the transceiver.

⚠ NEVER apply more than 16 V DC, such as a 24 V battery, to the [DC13.8V] socket on the transceiver rear panel. This could cause a fire or ruin the transceiver.

⚠ NEVER let metal, wire or other objects touch any internal part or connectors on the rear panel of the transceiver. This will cause electric shock.

⚠ NEVER expose the transceiver to rain, snow or any liquids.

NEVER allow children to play with the transceiver.

AVOID using or placing the transceiver in areas with temperatures below -10°C ($+14^{\circ}\text{F}$) or above $+60^{\circ}\text{C}$ ($+140^{\circ}\text{F}$). Be aware that temperatures on a vehicle's dashboard can exceed 80°C ($+176^{\circ}\text{F}$), resulting in permanent damage to the transceiver if left there for extended periods.

AVOID placing the transceiver in excessively dusty environments or in direct sunlight.

AVOID placing the transceiver against walls or putting anything on top of the transceiver. This will obstruct heat dissipation.

During mobile operation, **DO NOT** operate the transceiver without running the vehicle's engine. When transceiver power is ON and your vehicle's engine is OFF, the vehicle's battery will soon become exhausted.

Make sure the transceiver power is OFF before starting the vehicle. This will avoid possible damage to the transceiver by ignition voltage spikes.

During maritime mobile operation, keep the transceiver and microphone as far away as possible from the magnetic navigation compass to prevent erroneous indications.

BE CAREFUL! The heatsink will become hot when operating the transceiver continuously for long periods.

BE CAREFUL! If a linear amplifier is connected, set the transceiver's RF output power to less than the linear amplifier's maximum input level, otherwise, the linear amplifier will be damaged.

Use Icom microphones only (supplied or optional). Other manufacturer's microphones have different pin assignments and connection to the IC-821H may damage the transceiver.

EXPLICIT DEFINITIONS

WORD	DEFINITION
⚠ WARNING	Personal injury, fire hazard or electric shock may occur.
CAUTION	Equipment damage may occur.
NOTE	If disregarded, inconvenience only. No risk of personal injury, fire or electric shock.

The explicit definitions described at left apply to this instruction manual.



The IC-821H complies with the essential requirements of the 89/336/EEC directive for Electromagnetic Compatibility. This compliance is based on conformity with the ETSI specification prETS300 684 (EMC product standard for Commercially Available Amateur Radio Equipment).

TABLE OF CONTENTS

IMPORTANT	i	4 RECEIVE AND TRANSMIT . 21–30		9 SATELLITE OPERATION ... 39–41	
PRECAUTIONS	i	■ Functions for receive	21	■ Satellite communications outline ..	39
EXPLICIT DEFINITIONS	i	■ Functions for transmit	25	■ Panel description while in	
TABLE OF CONTENTS	ii	■ Functions for CW	27	satellite mode	39
UNPACKING	ii	■ Functions for AFSK	29	■ Satellite notes	40
1 PANEL DESCRIPTION	1–9			■ Operation	40
■ Front panel	1	5 FM REPEATER USE	31–32	■ Satellite VFO and satellite	
■ Function display	7	■ Operation	31	memory	41
■ Rear panel	8	■ Tone information	31	■ Satellite mode selection	41
■ Accessory socket information	9	■ Offset frequency	31	■ Satellite memory programming	41
■ Microphone (HM-12)	9	■ One-touch repeater	32		
		■ Optional tone scan	32	10 REMOTE JACK (CI-V)	
		■ Auto repeater function	32	INFORMATION	42
2 INSTALLATION AND				■ CI-V connection example	42
CONNECTIONS	10–14	6 MEMORY MODE	33–35	■ CI-V data format	42
■ Unpacking	10	■ Memory channels	33		
■ Selecting a location	10	■ Operation on a memory channel ...	33	11 SET MODE	43–49
■ Antenna	10	■ Memory channel selection	34		
■ Antenna connectors	10	■ Memory channel programming	34	12 OPTION INSTALLATIONS .. 50–52	
■ Required connections	11	■ Transferring memory contents	35	■ Opening the transceiver's case	50
■ Advanced connections	12	■ Memory clearing	35	■ Opening the inside chassis	50
■ Power supply connections	13	■ Scan edge channels	35	■ UT-84 TONE SQUELCH UNIT	51
■ Linear amplifier connections	14			■ FL-132/FL-133	
		7 CALL CHANNEL	36	CW NARROW FILTER	51
3 FREQUENCY SETTING	15–20	■ Call up a call channel	36	■ UT-102 VOICE SYNTHESIZER	
■ When first applying power		■ Call channel programming	36	UNIT	52
(CPU resetting)	15			■ CR-293 HIGH STABILITY	
■ Initial settings	15	8 SCANS	37–38	CRYSTAL UNIT	52
■ Main and sub bands	16	■ Scan types	37		
■ Exchanging the main and		■ Pre-operation	37	13 INTERNAL VIEWS	53
sub bands	16	■ Programmed scan operation	38		
■ Accessing the sub band	16	■ Memory scan operation	38	14 MAINTENANCE	54
■ VFO description	17	■ Mode select memory scan		■ Troubleshooting	54
■ Frequency setting	18	operation	38	■ Fuse replacement	54
■ Mode selection	19			■ CPU resetting	54
■ Dial lock function	19			■ Demonstration mode	54
■ Sub band OFF	19				
■ Sub tuning dial	20			15 SPECIFICATIONS	55
				16 OPTIONS	56

UNPACKING

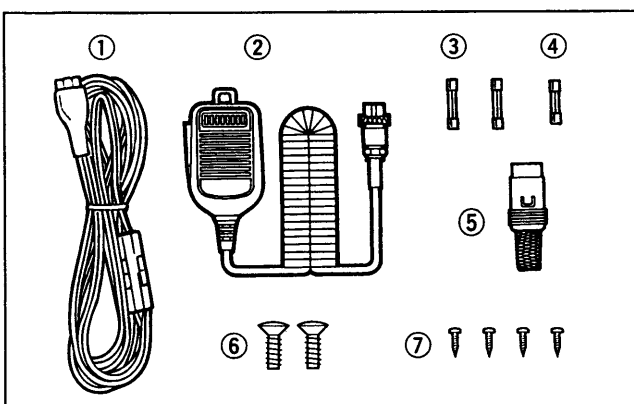

Accessories included with the IC-821H:	Qty.
① DC power cable (OPC-657)	1
② Hand microphone (HM-12)	1
③ Spare fuses (FGB 20 A)	2
④ Spare fuse (FGMB 125 V 5 A)	1
⑤ DIN plug	1
⑥ Screws (M4 × 10, for optional MB-23)	2
⑦ Screws (M3 × 6, for optional MB-23)	4

■ Front panel

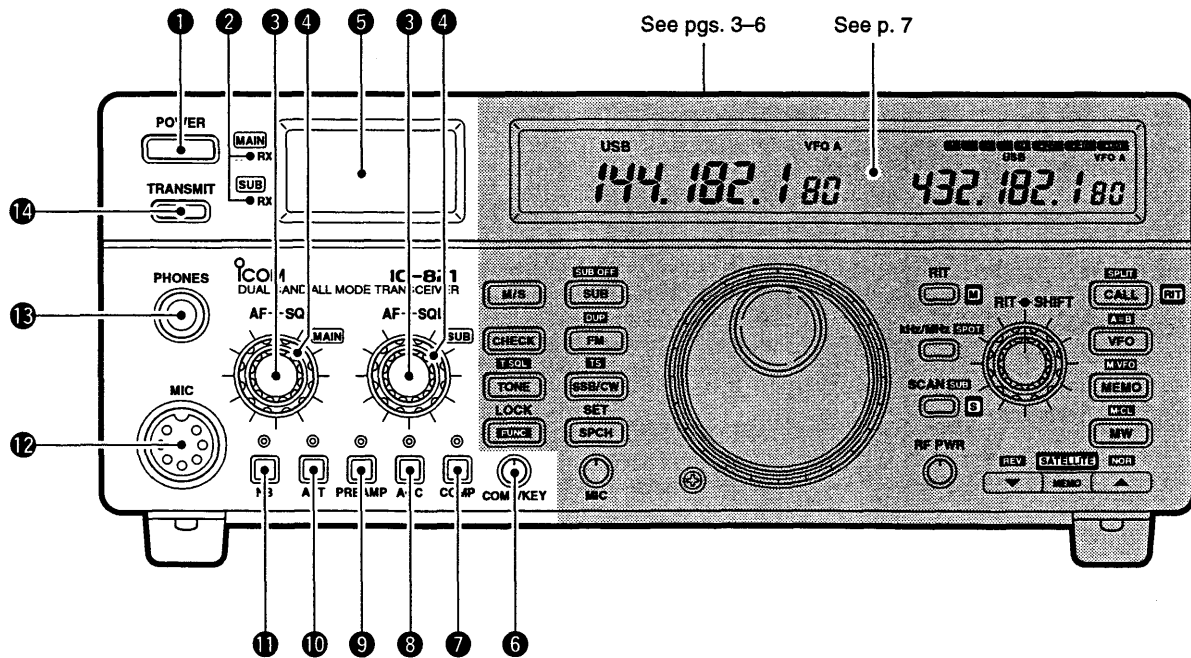

1 POWER SWITCH [POWER] (p. 15)

Turns power ON and OFF.
- Turn the optional DC power supply ON in advance.



2 TX/RX INDICATORS

- Light green while receiving a signal (and squelch opens) on the main or sub band. Lights red while transmitting.
- When ALC is activated, the transmit band's indicator brightness increases. (p. 25)
- Flash green when the center indicator is turned ON in set mode with the [FM] switch and an off-center signal is received in FM mode. (p. 23)

✓ What is the ALC function?

The ALC circuit automatically limits RF output power by controlling the input level of the RF power amplifier. This prevents transmission of distorted signals when the input signal level exceeds the allowable level. The ALC activates for SSB and CW modes.

3 AF CONTROLS [AF (MAIN)]/[AF (SUB)] (inner control)

Vary the audio output level from the speaker.

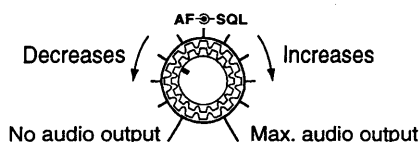

4 SQUELCH CONTROLS [SQL (MAIN)]/[SQL (SUB)] (outer control) (p. 21)

Adjust the squelch threshold level. The squelch removes noise output from the speaker (closed condition) when no signal is received.

- The squelch is particularly effective for FM. It is also available for other modes.
- Squelch threshold point for SSB/CW mode can be set to the 9 or 12 o'clock position in set mode with the [CHECK] switch. (p. 45)

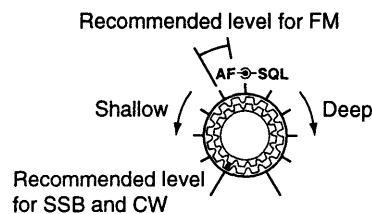

✓ How to set the squelch.

When operating in FM, first rotate the control fully counterclockwise. Then, rotate the control clockwise to the point where the noise just disappears. This is the optimum position. The squelch does not open for weak signals when it is set too deep (clockwise).

5 S/RF METER

Shows main band's signal strength while receiving. Shows the relative output power while transmitting.

6 COMPRESSOR/KEY SPEED CONTROL

[COMP/KEY] (pgs. 25, 27)

- Adjusts the speech compression level in SSB.
- Adjusts the keying speed of the internal electronic keyer in CW.

While in SSB mode



While in CW mode



7 SPEECH COMPRESSOR SWITCH [COMP]

(p. 25)

Turns the speech compressor ON and OFF. The speech compressor compresses the transmitter audio input to increase the average audio output level. Therefore, talk power is increased. This function is effective for long distance communication or when propagation conditions are poor.

- The compression level can be adjusted with the [COMP/KEY] control as above.



8 AGC SWITCH [AGC] (p. 23)

Changes the time constant of the main band AGC circuit. The AGC controls receiver gain to produce a constant audio output level even when the received signal strength is varied by fading, etc. Use AGC slow for normal operation and select AGC fast depending on the receiving condition.

- AGC does not function in FM mode.
- Sub band AGC is fixed depending on mode.



9 PREAMP SWITCH [PREAMP] (p. 23)

Turns an optional preamplifier, AG-25 or AG-35, ON and OFF.

- The transceiver applies DC voltage to the antennas when this switch is turned ON. Therefore, this switch should be set to OFF when no preamplifier is connected.
- The preamplifier can be used on one band, both bands or neither according to the selection in set mode with the [PREAMP] switch. (p. 49)



10 ATTENUATOR SWITCH [ATT] (p. 23)

Turns the 15 dB attenuator ON and OFF. The attenuator prevents a desired signal from distorting when very strong signals are near the desired frequency or when very strong electric fields, such as from a broadcasting station are near your location.

- The attenuator can be used on one band only or both bands according to the selection in set mode with the [ATT] switch. (p. 49)



11 NOISE BLANKER SWITCH [NB] (p. 22)

Turns both band's noise blankers ON and OFF. The noise blanker reduces pulse-type noise such as that generated by automobile ignition systems. This function cannot be used for FM, or non-pulse-type noise.

- The noise blanker functions for both bands simultaneously.



12 MICROPHONE CONNECTOR [MIC]

Accepts the supplied or optional microphone.

- See p. 56 for appropriate microphones.
- See p. 9 for microphone connector information.

13 HEADPHONE JACK [PHONES]

Accepts headphones.

- The main and sub band audio can be mixed or separated when using stereo headphones using set mode with the [M/S] switch. (p. 44)
- When headphones are connected, the internal speaker or connected external speaker does not function.

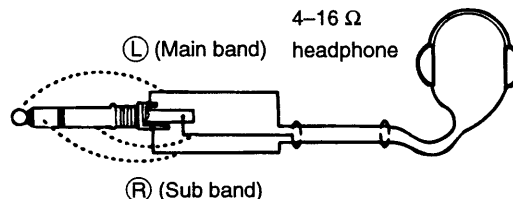

14 TRANSMIT SWITCH [TRANSMIT]

Selects transmitting or receiving.



1 PANEL DESCRIPTION

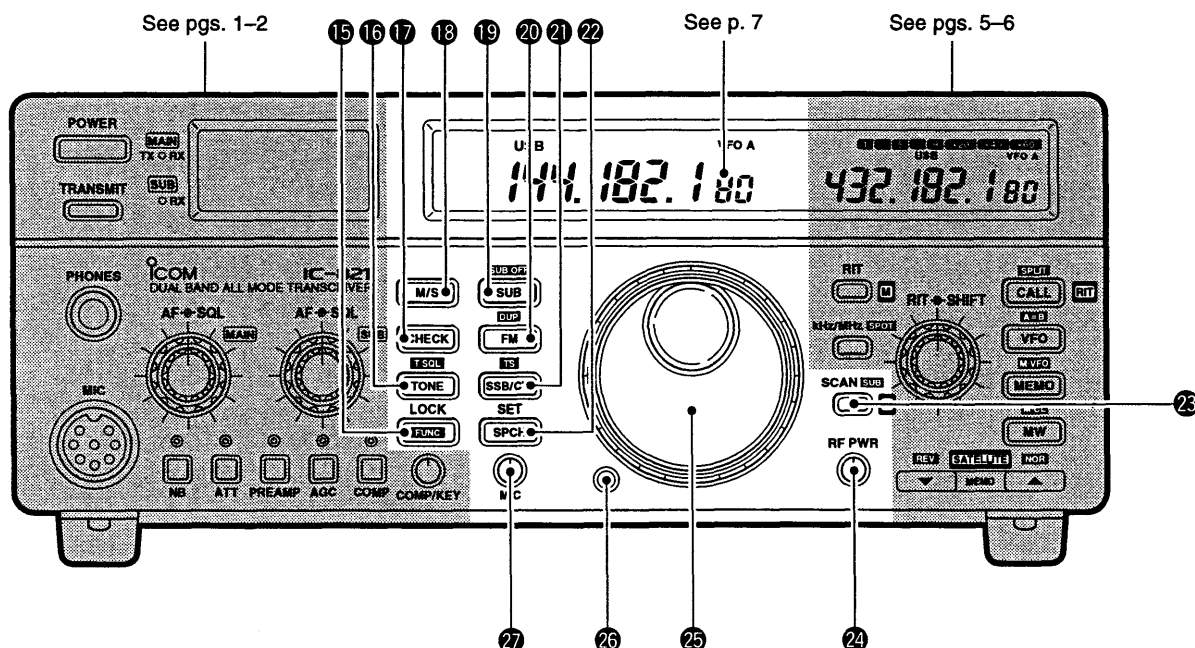

15 FUNCTION/LOCK SWITCH [FUNC•LOCK]

[FUNC]

- Activates the secondary function of some switches.
- Turns the dial lock function ON and OFF when pushed for 2 sec. (p. 19)
 - The dial lock function electronically locks the tuning dial.

LOCK
[FUNC]

Push and hold

16 TONE SWITCH [TONE•T SQL] (p. 31)

[TONE]

- Turns the subaudible tone encoder ON and OFF in FM mode. (U.S.A. and Australia versions)
- Transmits a 1750 Hz tone call signal when pushed in FM mode. (Europe and Sweden versions)

[TONE]

[FUNC]

then

[TSQL]

[TONE]

- Activates an optional tone squelch function after pushing [FUNC] for rejecting undesired signal reception. (p. 24)
 - The tone squelch can be used on both the main and sub bands simultaneously with an optional UT-84 TONE SQUELCH UNIT.

17 FREQUENCY CHECK SWITCH [CHECK]

(pgs. 21, 24, 31)

Opens the squelch manually to check the operating frequency condition.

- Checks the transmit frequency simultaneously when selecting duplex or split operation.

18 MAIN/SUB EXCHANGE SWITCH [M/S]

- Replaces the main band's frequency and mode with the sub band's. (p. 16)
- Displays the 10 Hz digits when pushed and held.

19 SUB BAND SWITCH [SUB•SUB OFF] (p. 16)

[SUB]

- Activates the sub band access function to control the sub band's frequency/mode while standing by on the main band.
 - "SUB" appears in the function display while the function is in use.

[FUNC]

then

[SUB OFF]

[SUB]

- Toggles the sub band activation ON or OFF after pushing [FUNC]. (p. 19)

"SUB" appears.

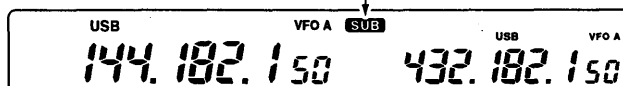

20 FM MODE SWITCH [FM•DUP]

[FM]

- Selects an FM mode. (p. 19)
 - FM mode with a duplex/subaudible tone encoder setting is selected when pushing twice on the main band. (U.S.A. and Australia versions)

[FUNC]

then

[DUP]

[FM]

- Selects -duplex, +duplex or cancels duplex (simplex) on the main band in sequence after pushing [FUNC]. (p. 31)

- An auto-repeater function is available to activate duplex and the subaudible tone encoder automatically when in a repeater frequency range. (U.S.A. and Australia versions)

[FM]

and

[TONE]

+

POWER

- Enters the repeater range programming mode for the auto-repeater function when pushed with [FM] and [TONE] at power ON. (p. 32) (U.S.A. and Australia versions)

21 SSB/CW MODE SWITCH [SSB/CW•TS]



•Selects USB, LSB, CW or CW-Narrow* mode in sequence. (p. 19)

*When optional CW narrow filter is not installed, no audio is output in CW-N mode.

•Indicates accessed band's tuning step increments after pushing [FUNC]; use the tuning dial to change the tuning steps. (p. 18)

- Tuning steps can be separately selected for FM and SSB/CW.

FM : 0.1, 5, 10, 12.5, 20, 25, 100 kHz

SSB/CW : 1, 10, 50, 100 Hz



22 SPEECH/SET MODE SWITCH [SPCH•SET]



•Announces the accessed band's frequency, mode, etc. when an optional UT-102 VOICE SYNTHESIZER UNIT is installed. (pgs. 46, 52)

•Enters set mode when pushed for 2 sec. Push the following switch to access set mode contents. (p. 43)

- The [M/S], [CHECK], [TONE], [FUNC], [SUB], [FM], [SSB/CW], [RIT], [kHz/MHz], [SCAN], [ATT] and [PREAMP] switches have set mode content(s).



23 SCAN SWITCH [SCAN•SUB•S]



•Starts and stops the accessed band programmed scan, memory scan or mode select memory scan. (p. 38)

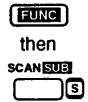

•Starts and stops the sub band programmed scan, memory scan or mode select memory scan after pushing [FUNC]. (p. 38)



Push in satellite mode

•Cancels the tracking function when pushed; the tuning dial changes the sub band only, for Doppler shift compensation, in satellite mode. (p. 40)



Push and hold

•Starts the optional tone scan when the tone squelch is in use and pushed for 2 sec. (p. 32)

- An optional UT-84 TONE SQUELCH UNIT is required.

24 RF POWER CONTROL [RF PWR] (p. 25)

Adjusts the RF output power continuously.

- VHF FM/CW 45-6 W
- SSB 35-6 W
- UHF FM/CW 40-6 W
- SSB 30-6 W



25 TUNING DIAL (p. 18)

Changes the displayed frequency, etc.

- While rotating the tuning dial in SSB/CW mode and in 1, 10 or 50 Hz tuning steps, the memory channel read-out shows below the 10 Hz-digit. This returns to channel number indication 1 sec. after tuning.

Tuning rates (frequency change/rotation of tuning dial)

MODE	Selected tuning step	Normal rotation	Rapid rotation
SSB, CW	1 Hz	400 Hz	4 kHz
	10 Hz	4 kHz	20 kHz
	50 Hz	10 kHz	20 kHz
	100 Hz	20 kHz	20 kHz
FM	5 kHz	250 kHz	250 kHz

26 BRAKE ADJUSTMENT SCREW

Adjusts the tuning dial tension.

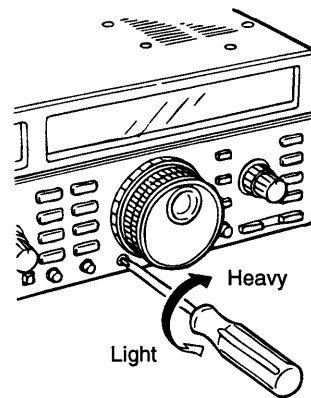

27 MIC GAIN CONTROL [MIC] (p. 25)

Adjusts microphone input gain.

- For SSB mode, adjust the [MIC] control so the [TX] indicator brightly illuminates (ALC activates) periodically during normal voice transmission.

Recommended level for an Icom microphone

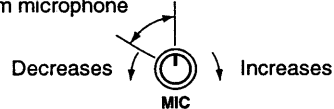

1 PANEL DESCRIPTION

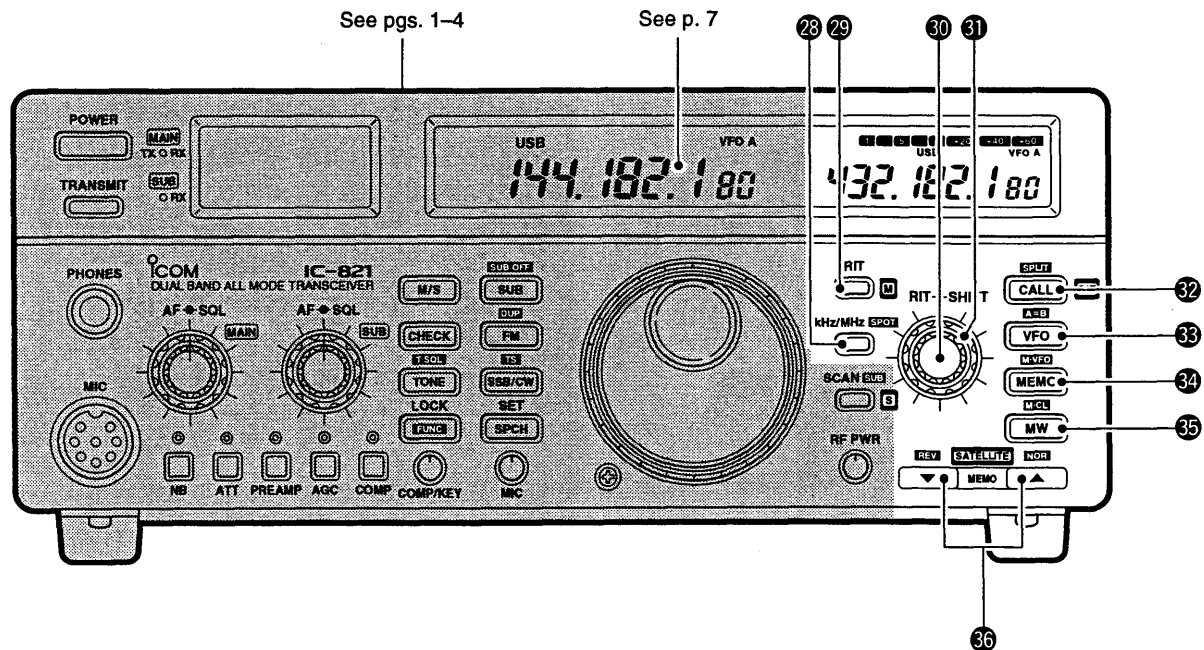

28 QUICK TUNING/SPOT FREQUENCY SWITCH [kHz/MHz•SPOT]

kHz/MHz SPOT



- Selects the 1 kHz or a pre-selected normal tuning step when pushed. (p. 18)

kHz/MHz SPOT



Push and hold

- Selects the 1 MHz tuning step when pushed for 2 sec. (p. 18)

FUNC



then

kHz/MHz SPOT



- Programs displayed frequency as a spot frequency for future reference after pushing [FUNC]. (p. 24)

"▼" indicates the selected quick tuning step.

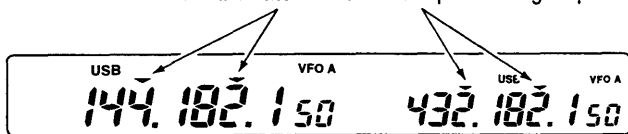

29 RIT SWITCH [RIT•M]



- Turns the RIT function ON and OFF when pushed. (p. 21)

- Use the [RIT] control to vary the RIT frequency.



Push and hold

- Activates the sub tuning dial function according to the selection in set mode with the [RIT] switch when pushed for 2 sec. (p. 20)



Push in satellite mode

- Cancels the tracking function when pushed; the tuning dial changes the main band only in satellite mode. (p. 40)

✓ What is the RIT function?

The RIT (Receiver Incremental Tuning) shifts the receive frequency without shifting the transmit frequency.

This is useful for fine tuning stations calling you on an off-frequency or when you prefer to listen to slightly different sounding voice characteristics, etc.

30 RIT CONTROL [RIT]

- Shifts the main band receive frequency without changing the transmit frequency while the RIT function is ON. (p. 21)

- Rotate the control clockwise to increase the receive frequency, or rotate the control counterclockwise to decrease the receive frequency.

- The shift frequency range depends on mode:

SSB/CW : ±1.0 kHz in 10 Hz steps

FM : ±5.0 kHz in 50 Hz steps

- Can be used as the sub tuning dial, sub band RIT control or sub band IF shift control according to the selection in set mode with the [RIT] switch. (p. 20)

✓ What is the sub tuning dial?

The sub tuning dial allows you to change the frequency without using the tuning dial. Tuning speed varies according to the control rotation. However, this is not a scan function, therefore, tuning does not stop, even when detecting a signal. The control is convenient when you want to search both the main and sub bands.

31 IF SHIFT CONTROL [SHIFT]

- Shifts the center frequency of the main band IF in SSB and CW modes. (p. 22)
 - The shift frequency range: ± 1.2 kHz in 100 Hz steps.
- Can be used as the sub tuning dial, sub band RIT control or sub band IF shift control according to the selection in set mode with the [RIT] switch. (p. 20)
 - See the description on the previous page for details.

✓ What is the IF shift control?

The IF shift electronically changes the IF passband frequency to reject interference. The IF shift is especially effective in SSB operation and is not available in FM operation.

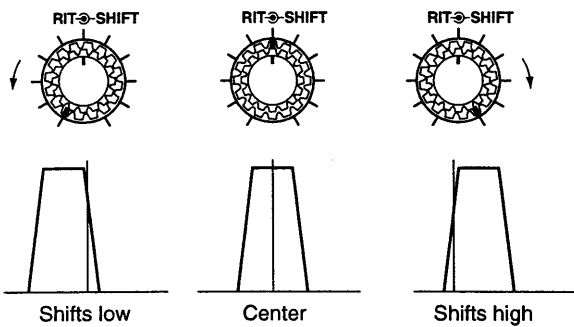

32 CALL SWITCH [CALL-SPLIT-RIT]

- [CALL] [RIT] • Calls up the call channel. (p. 36)
- [CALL] [RIT] • Turns the RIT function ON and OFF while in satellite mode. (p. 39)
- [FUNC] then [SPLIT] [CALL] [RIT] • Turns the split function ON and OFF after pushing [FUNC]. (p. 26)
 - This function is available in VFO mode only.

33 VFO SWITCH [VFO-A=B] (p. 17)

- [VFO] • Selects VFO mode and toggles VFO A and B.
- [FUNC] then [A=B] [VFO] • When pushed for 2 sec. after pushing [FUNC], equalizes the contents (frequency, operating mode, etc.) of the two VFOs.
 - The rear (undisplayed) VFO contents are equalized to the front (displayed) VFO contents.

Push and hold

34 MEMORY SWITCH [MEMO-M-VFO] (p. 33)

- [MEMO] • Selects memory mode.
 - When the selected channel is not programmed, a selected band name (140 or 400) appears 2 sec. after the selection.
- [MEMO] with a dial icon • While pushed and held, the tuning dial changes the memory channel.
- [FUNC] then [MEMO] • When pushed for 2 sec. after pushing [FUNC], transfers the programmed contents in the selected memory channel to a VFO.
 - This function is available both in VFO and memory modes.

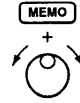

Push and hold

35 MEMORY WRITE SWITCH [MW-M-CL] (p. 33)

- [MW] • Stores displayed frequency and mode into the displayed memory channel when pushed for 2 sec.
 - This function is available both in VFO and memory modes.
- [FUNC] then [M-CL] [MW] • Clears memory channel contents when pushed for 2 sec. after pushing [FUNC].
 - This switch does not function in VFO mode.



Push and hold

36 MEMORY UP/DOWN SWITCHES [MEMO UP/DOWN-SATELLITE NOR/REV] (pgs. 33, 39)

- [UP] or [DOWN] • Select the memory channel number.
 - Memory channel can be selected both in VFO and memory modes.
- [FUNC] then [NOR] or [REV] • Enter satellite mode after pushing [FUNC] to track the main and sub bands frequencies.
 - When selecting satellite mode, the [VFO] switch selects satellite VFO mode and the [MEMO] switch selects satellite memory mode.
- [FUNC] then [NOR] or [REV] • Exit satellite mode after pushing [FUNC].
- [FUNC] then [NOR] or [REV] • Enter and exit satellite mode using the current operating frequencies when pushing one of these for 2 sec. after pushing [FUNC].

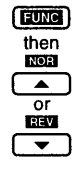
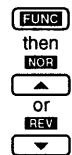

Push and hold

[FUNC] then [REV] Indicates reverse tracking for the uplink and downlink frequencies.

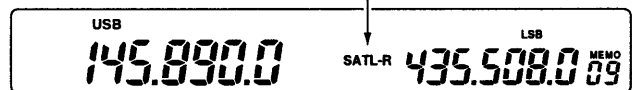

[FUNC] then [NOR] Indicates normal tracking for the uplink and downlink frequencies.

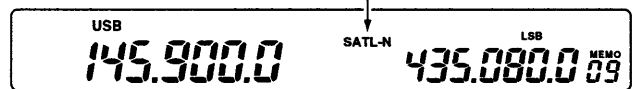

Downlink frequency

Uplink frequency

■ Function display

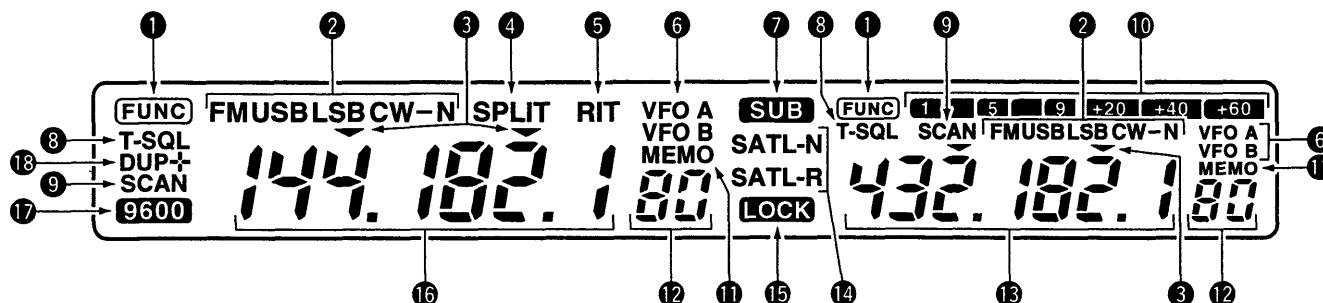

1 FUNCTION INDICATORS

Appear when the [FUNC] switch is pushed.

2 MODE INDICATORS

Show the selected operating mode.

3 QUICK TUNING INDICATORS (p. 18)

Appear above the selected digit to indicate the quick tuning function is activated.

4 SPLIT INDICATOR (p. 26)

Appears when the split function is in use.
- VFO A and B are used for transmit and receive frequencies, and vice versa.

5 RIT INDICATOR

- Appears when the RIT function is in use. (p. 21)
- Flashes when the sub tuning dial (or sub band IF shift control) is activated. (p. 20)

6 VFO INDICATORS (p. 17)

The selected VFO, VFO A or VFO B, appears when VFO mode is selected.

7 SUB BAND ACCESS INDICATOR (p. 16)

Appears when the sub band access function is in use.
- While this indicator appears, the tuning dial and most switches are activated for sub band control.

8 TONE INDICATORS

- "T" appears when the subaudible tone encoder is in use. (p. 31) (U.S.A. and Australia versions only)
- "T-SQL" appears when the optional tone squelch is in use. (p. 24)

9 SCAN INDICATORS (p. 37)

Appear while scanning.

10 SUB BAND S-METER

Shows the signal strength of the sub band received signal. Shows the relative output power while transmitting in satellite mode.
- The sub band S-meter can be turned OFF in set mode with the [SUB] switch if desired. (p. 46)

11 MEMORY MODE INDICATORS (p. 33)

Show that memory mode is selected.

12 MEMORY CHANNEL READOUTS (p. 33)

- Show the selected memory channel number while the tuning dial is not rotated.
- Show the 10 and 1 Hz digits when the fine indication is turned ON and the tuning dial is rotated. (pgs. 18, 46)
- The main band's memory channel readout disappears when satellite mode is selected. (p. 39)

13 SUB BAND FREQUENCY READOUT (p. 16)

- Shows the sub band operating frequency.
- Shows the uplink (transmit) frequency during satellite operation. (p. 39)

14 SATELLITE MODE INDICATORS (p. 39)

One of the indicators appears when satellite mode is selected.
- "SATL-N" shows that normal tracking is selected;
"SATL-R" shows that reverse tracking is selected.

15 DIAL LOCK INDICATOR (p. 19)

Shows that the dial lock function is activated.

16 MAIN BAND FREQUENCY READOUT (p. 16)

- Shows the main band operating frequency.
- The main band can be used for transmitting and receiving during normal operation.
- Shows the downlink (receive) frequency during satellite operation. (p. 39)

17 9600 BPS INDICATOR (pgs. 29, 43)

Shows that the 9600 bps data mode is selected.

18 DUPLEX INDICATOR (p. 31)

"DUP-" or "DUP+" appears while -duplex or +duplex operation is selected, respectively.

■ Rear panel

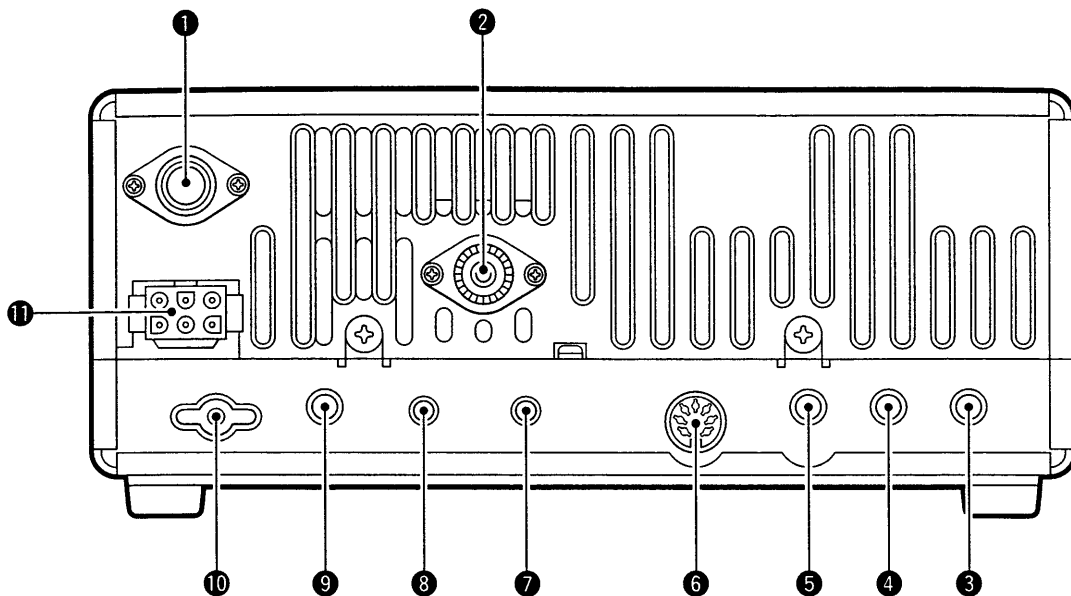

1 430 MHz BAND ANTENNA CONNECTOR [430MHz ANT] (p. 11)
Connects a 430 MHz band antenna with a type-N connector.

2 144 MHz BAND ANTENNA CONNECTOR [144MHz ANT] (p. 11)
Connects a 144 MHz band antenna with a PL-259 connector.

3 CI-V REMOTE CONTROL JACK [REMOTE] (p. 42)

- Designed for use with a personal computer for remote control of transceiver functions.
- Used for transceive operation with another Icom CI-V transceiver or receiver.

4 SUB BAND EXTERNAL SPEAKER JACK
5 MAIN BAND EXTERNAL SPEAKER JACK [SUB SP]/[MAIN SP] (pgs. 12, 56)
Accept 8 Ω speaker(s). An external speaker may be convenient for simultaneous receiving on the main and sub bands.

Audio output	Speaker connection			
	No connection	[MAIN SP] only	[SUB SP] only	Both jacks
Main band	Internal (Mixed)	External (Mixed)	Internal (Separated)	External (Separated)
Sub band	Internal (Mixed)	External (Mixed)	External (Separated)	External (Separated)

6 ACCESSORY SOCKET [ACC(1)] (pgs. 9, 29)
Enables connection to external equipment such as a linear amplifier, TNC, etc.

7 CW SIDE TONE CONTROL [CW SIDE TONE] (p. 28)
Adjusts the CW side tone level to monitor CW keying.

8 BREAK-IN DELAY TIME CONTROL [DELAY] (p. 27)
Adjusts the transmit-to-receive switching delay time for CW semi break-in operation.

9 CW KEY JACK [KEY] (p. 27)
Accepts a CW keyer or external electronic keyer for CW operation.
- 3.5 mm diam. 3-conductor plug must be used even when a straight key is connected.

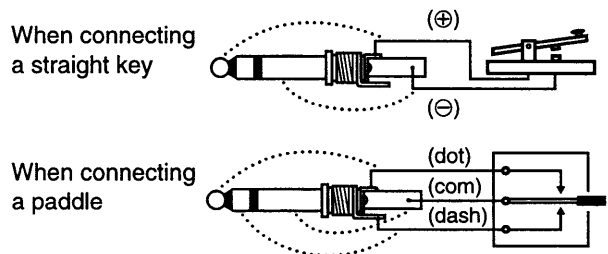

10 GROUND TERMINAL [GND] (p. 11)
Connect this terminal to a ground to prevent electrical shocks, TVI, BCI and other problems.

11 DC POWER SOCKET [DC 13.8V] (p. 13)
Accepts 13.8 V DC through the supplied DC power cable (OPC-657).

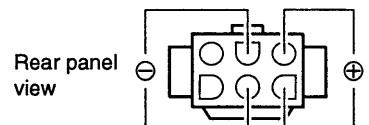

■ Accessory socket information

ACC(1)	PIN NO.	PIN NAME	DESCRIPTION	SPECIFICATIONS
 <p>Rear panel view</p>	1*	ATVM	ATV microphone output.	—
		AF	Main or sub band AF detector output. Fixed, regardless of [AF] position. (controlled by the squelch circuit)	Output impedance : 4.7 kΩ Output level : 100 to 300 mV rms
	2	GND	Ground for microphone output.	—
	3	SEND	Input/output pin. Goes to ground when transmitting. When grounded, transmits.	Ground level : -0.5 to 0.8 V Input current : Less than 200 mA
	4*	AMOD	Modulator input. The input level is selectable. (p. 44)	Input impedance : 10 kΩ Input level : 100 or 2 mV rms
		PACT	Direct modulator input for 9600 bps data operation.	Regular input level : 1.0 Vp-p (0.35 V rms) Max. input level : 1.6 Vp-p (0.56 V rms)
	5*	AF	Main or sub band AF detector output.	Same as pin 1 above.
		DISC	Main or sub band direct detector output for 9600 bps data operation.	Output impedance : 4.7 kΩ Output level : 300 mV rms
	6*	SQL	Main or sub band squelch output. Goes to ground when squelch opens.	Squelch open : Less than 0.3 V/5 mA Squelch closed : More than 6.0 V/100 μA
	7	13.8 V	13.8 V output when power is ON.	Output current : Max. 1 A
	8*	ALC	ALC voltage input/output.	Control voltage : -4 to 0 V Input impedance : More than 10 kΩ
		MIC UD	Microphone up/down input.	Same as the [MIC] connector pin ③ below.

*The function of pins 1, 4, 5, 6 and 8 are selectable in set mode with the [M/S] switch. (pgs. 43, 44)

■ Microphone (HM-12)

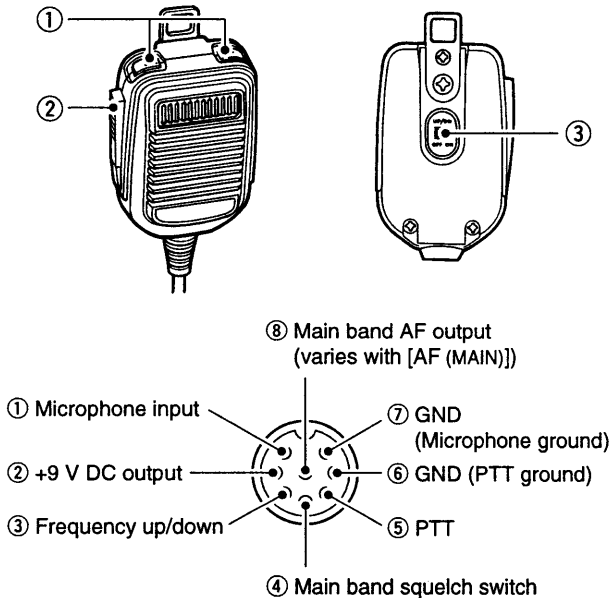

PIN NO.	FUNCTION	DESCRIPTION
②	+9 V DC output	Max. 10 mA
③	Frequency up	Ground
	Frequency down	Ground through 470 Ω
④	Squelch open	"LOW" level
	Squelch closed	"HIGH" level

① UP/DOWN SWITCHES [UP]/[DN]

Change the operating frequency or memory channel.

- Continuous pushing changes the frequency or memory channel number continuously.

② PTT SWITCH

Push and hold to transmit; release to receive.

③ UP/DOWN ON/OFF SWITCH [ON/OFF]

Activates and deactivates the [UP]/[DN] switch control to prevent accidental frequency changes.

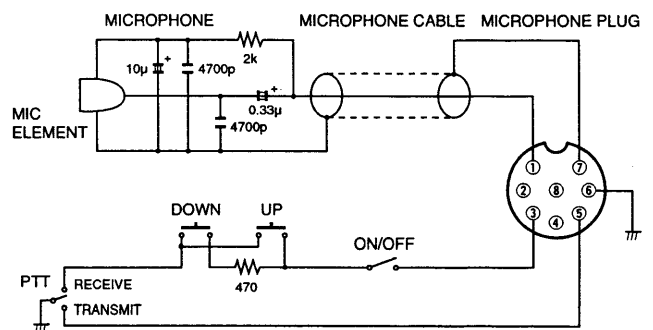

CAUTION: DO NOT short pin 2 to ground as this can damage the internal 9 V regulator.

■ Unpacking

After unpacking, immediately report any damage to the delivering carrier or dealer. Keep the shipping cartons.

For a description and a diagram of accessory equipment included with the IC-821H, see UNPACKING on p. ii of this manual.

■ Selecting a location

Select a location for the transceiver that allows adequate air circulation, free from extreme heat, cold, or vibrations, and away from TV sets, TV antenna elements, radios and other electro-magnetic sources.

OPERATING ANGLE ADJUSTMENT

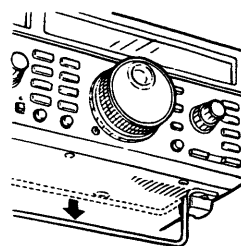

The stand on the bottom of the transceiver provides two operating angles.

■ Antenna

For radio communications, the antenna is of critical importance, along with output power and sensitivity. Select good antennas and mounting locations. The transceiver accepts a 50 Ω antenna and less than 3:1 of Voltage Standing Wave Ratio (VSWR).

The transceiver requires 2 antennas for 144 and 430 MHz operation. Of course, the transmission line should be a coaxial cable.

CAUTION: Protect your transceiver from lightning using a lightning arrester.

■ Antenna connectors

PL-259 CONNECTOR INSTALLATION (for 144 MHz antenna)

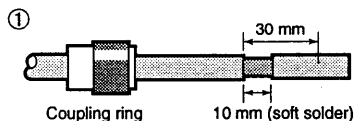

Slide the coupling ring down. Strip the cable jacket and soft solder.

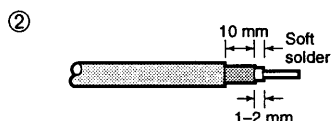

Strip the cable as shown at left. Soft solder the center conductor.

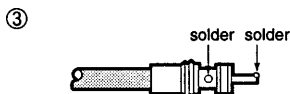

Slide the connector body on and solder it.

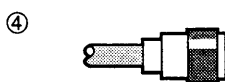

Screw the coupling ring onto the connector body.

30 mm ≈ 9/8 in 10 mm ≈ 3/8 in 1-2 mm ≈ 1/16 in

TYPE-N CONNECTOR INSTALLATION (for 430 MHz antenna)

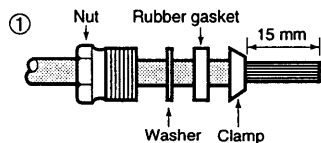

Slide the nut, rubber gasket and clamp over the coaxial cable, then cut the end of the cable evenly.

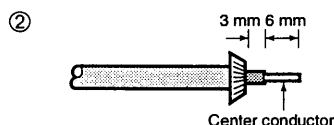

Strip the cable and fold the braid back over the clamp.

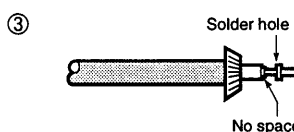

Soft solder the center conductor. Install the center conductor pin and solder it.

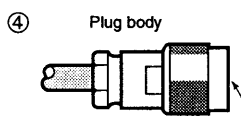

Carefully slide the plug body into place aligning the center conductor pin on the cable. Tighten the nut onto the plug body.

15 mm ≈ 5/8 in 6 mm ≈ 1/4 in 3 mm ≈ 1/8 in

Required connections

• Front panel

MICROPHONE



HM-12 SM-20

For phone operation (FM or SSB), connect the supplied HM-12 HAND MICROPHONE to this connector. See p. 56 for optional microphone details.

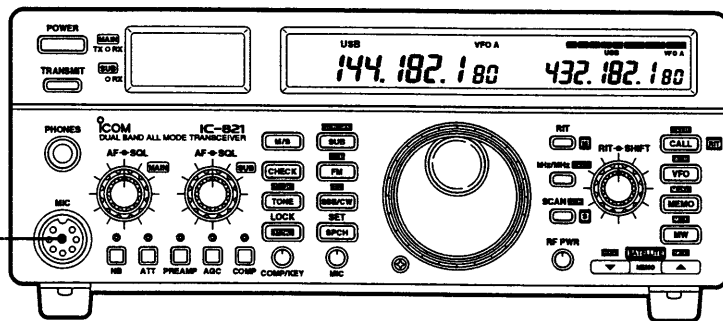

• Rear panel

POWER SUPPLY

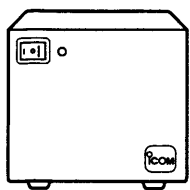

PS-85

See p. 13 for details.

430 MHz ANTENNA

144 MHz ANTENNA

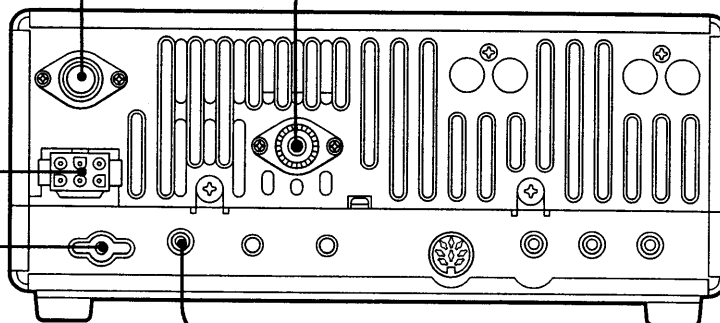

GROUNDING

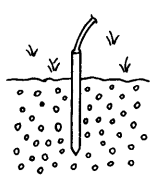

Use the heaviest gauge wire or strap available and make the connection as short as possible.

Grounding prevents electrical shocks, TVI and other problems.

⚠ WARNING: NEVER connect the [GND] terminal to a gas or electric pipe, since the connection could cause an explosion or electric shock.

KEY JACK

For CW operation, the transceiver accepts a straight key,* paddle or an external electronic keyer.

*When connecting a straight key

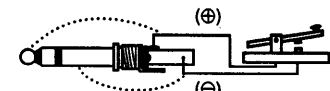

When connecting a paddle

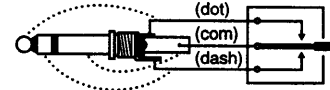

NOTE: A stereo plug must be used even when a straight key is used, otherwise, the transceiver transmits for a while at power ON. The connection cable should be less than 3 m (9.8 ft).

Advanced connections

• Front panel

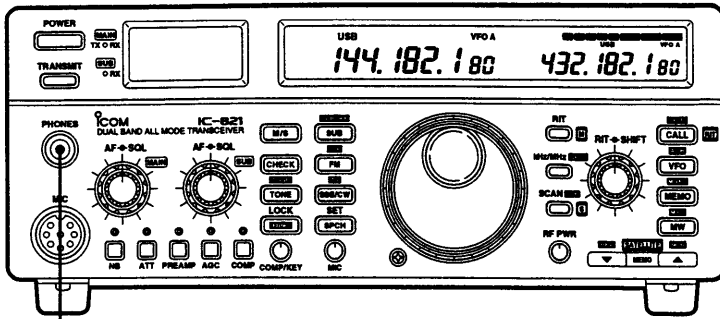

HEADPHONES

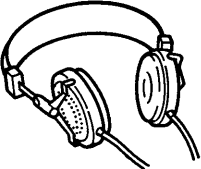

When using stereo headphones, the main and sub band audio can be separated. See p. 44 for separated audio.

MB-23 CARRYING HANDLE

For portable operation.

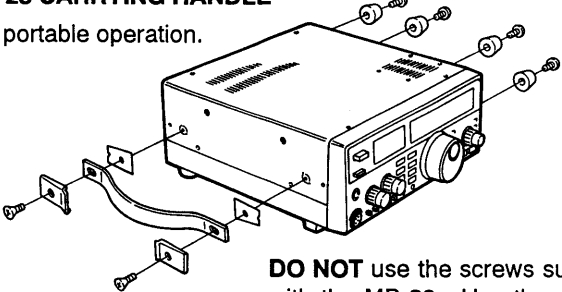

DO NOT use the screws supplied with the MB-23. Use the screws supplied with the transceiver.

• Rear panel

ANTENNA MOUNTING TYPE PREAMPLIFIER

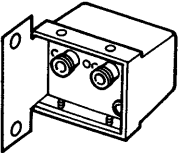

144 MHz band
AG-25

430 MHz band
AG-35

COMPUTER CONTROL AND TRANSCEIVE (p. 42)

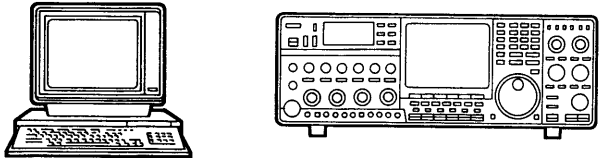
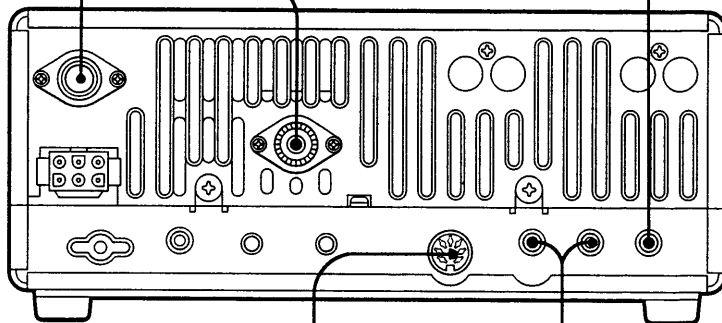
DATA COMMUNICATIONS

TNC or TU (Terminal unit) (pgs. 9, 29)

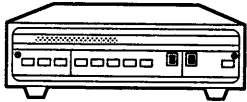

The connection cable should be less than 3 m (9.8 ft).

EXTERNAL SPEAKERS

Up to 2 external speakers can be connected for separate audio output of the main and sub bands. (pgs. 8, 56)

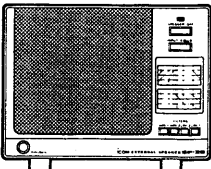

SP-20

2 INSTALLATION AND CONNECTIONS

■ Power supply connections

Use an optional PS-85 DC POWER SUPPLY, etc. when operating the transceiver with AC power. Refer to the diagram below.

CAUTION: Before connecting the DC power cable, check the following important items. Make sure:

- The [POWER] switch is OFF.
- Output voltage of the power source is 12–15 V when you use a non-Icom power supply.
- DC power cable polarity is correct.
Red : positive ⊕ terminal
Black : negative ⊖ terminal

CONNECTING AN ICOM DC POWER SUPPLY

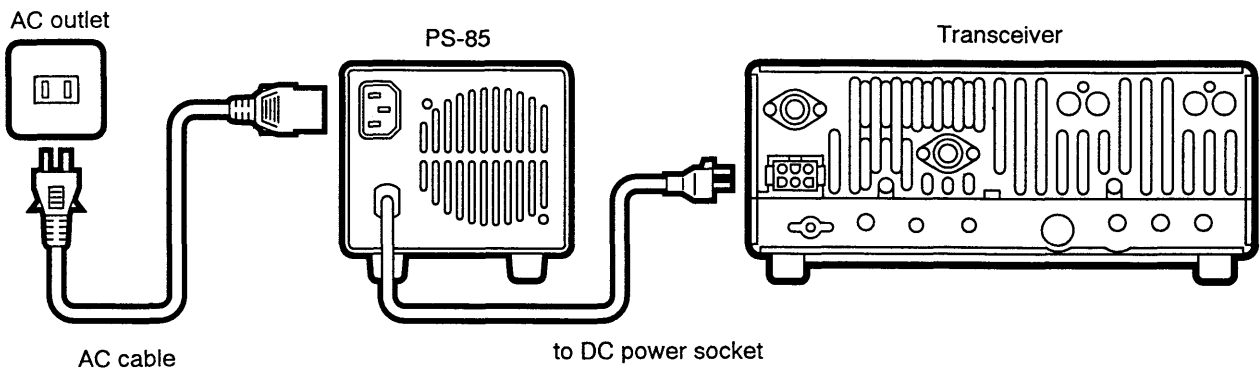

CONNECTING A NON-ICOM DC POWER SUPPLY

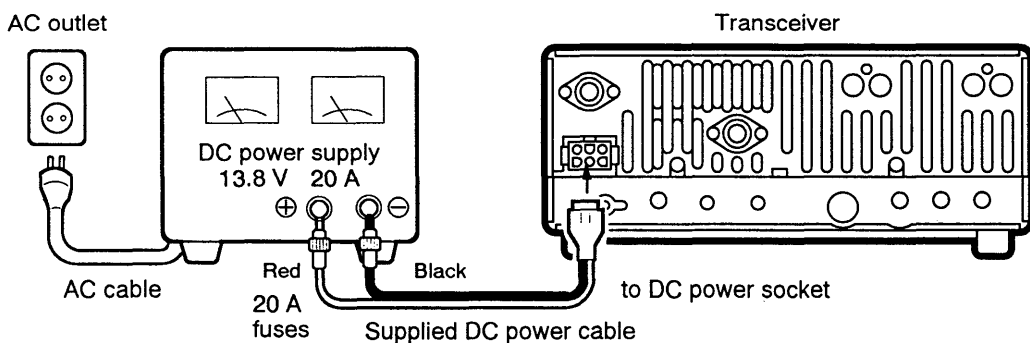

CONNECTING A VEHICLE BATTERY

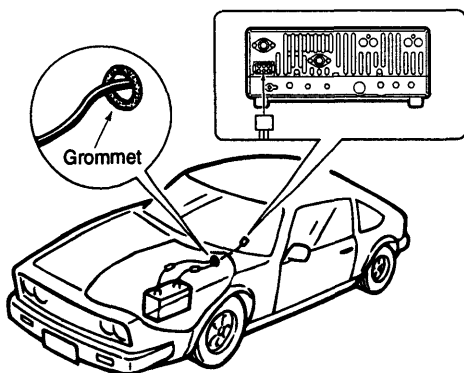

NEVER connect to a 24 V battery.

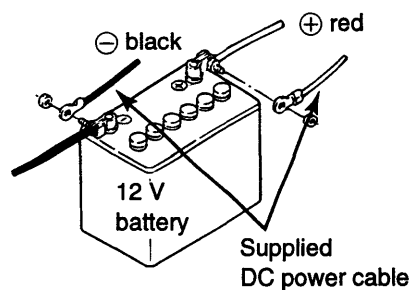

NOTE: Use terminals for the cable connections.

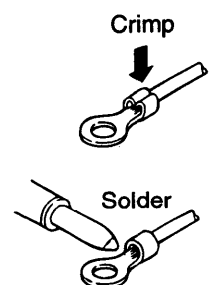

■ Linear amplifier connections

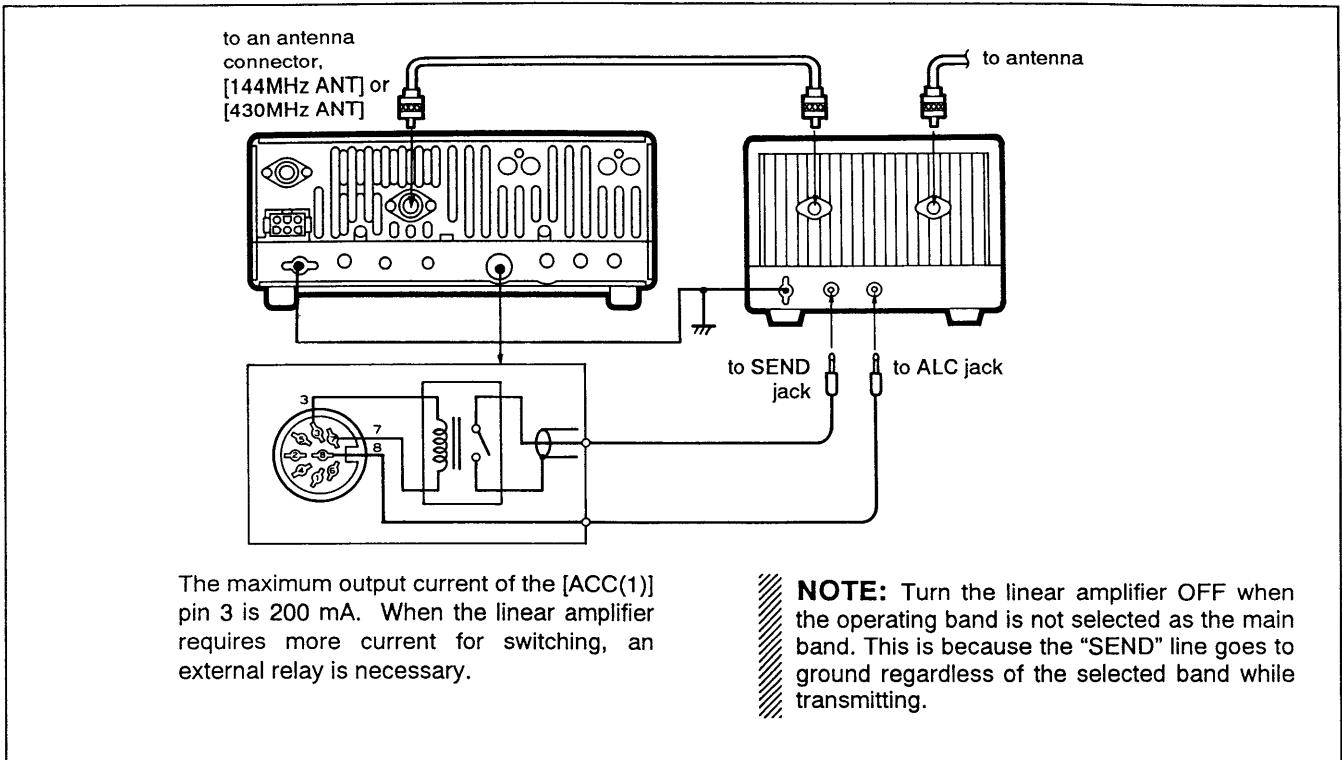

3 FREQUENCY SETTING

When first applying power (CPU resetting)

Before first applying power, make sure all connections required for your system are complete by referring to section 2. Then, reset the transceiver using the following procedure.

NOTE: Resetting CLEARS all programmed contents in memory channels and returns programmed values in set mode to default values.

- ① Make sure the transceiver power is OFF.
- ② While pushing [MW•M-CL], push IN [POWER] to turn power ON.
 - The internal CPU is reset.
 - The transceiver displays its initial VFO frequencies when resetting is complete.

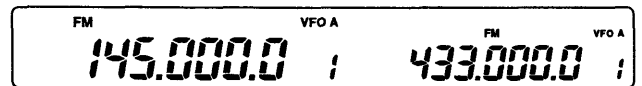
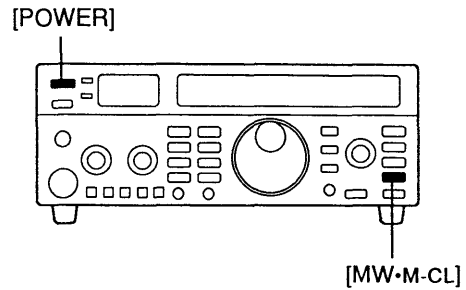

The transceiver displays its initial frequencies. (The initial frequency and mode depend on version.)

Initial settings

After resetting the transceiver, set controls and switches as shown in the figure below.

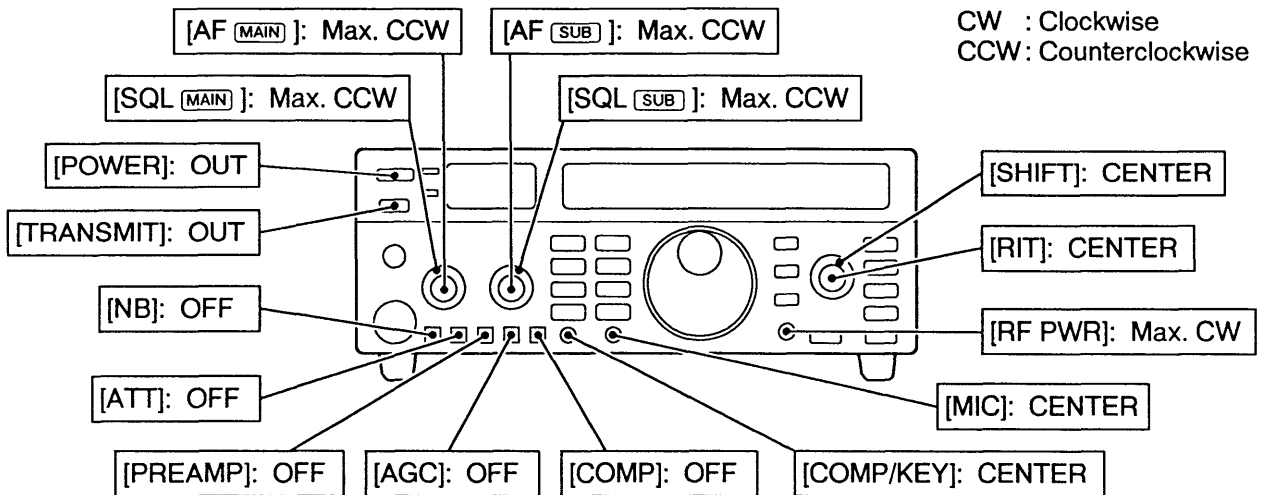

Turn power ON, then check the display.

If any of the following indicators appear, turn them OFF as follows:

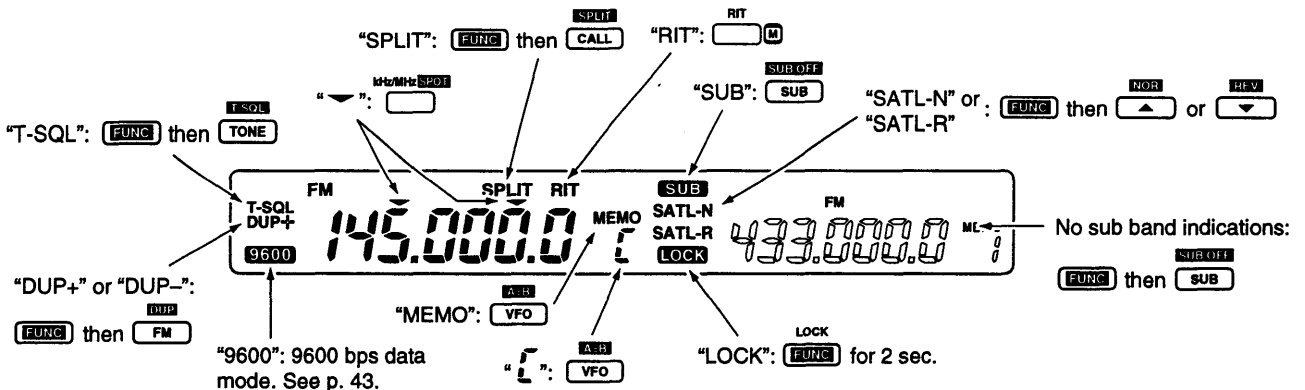

■ Main and sub bands

The transceiver has dual bands: VHF and UHF. These bands can be assigned to the main and sub bands for operating convenience.

The main and sub bands each have independent features as described below:

The display shows the VHF and UHF bands are assigned to the main and sub bands, respectively.

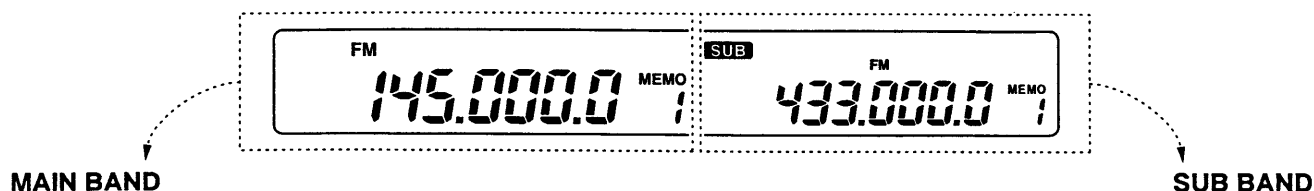

- Receive and transmit are both possible.
 - Receive only when operating in satellite mode.
- Downlink frequency when operating in satellite mode.
- CW-Narrow mode can be used when the optional FL-132 CW NARROW FILTER is installed. In satellite mode, an optional FL-133 is necessary because the sub band receive unit is used for the main band in satellite mode. (p. 51)
- Analog meter for receive S-meter and transmit power meter.
- Low beep tone is emitted when a switch is pushed for the main band; the beep tone can be turned OFF if desired. (p. 45)

- Receive only.
 - Receive and transmit are both possible when operating in satellite mode.
- Uplink frequency when operating in satellite mode.
- The sub band can be turned OFF if desired.
- CW-Narrow mode can be used when the optional FL-133 CW NARROW FILTER is installed. (p. 51)
- The bar meter in the function display can be turned OFF if desired. (p. 46)
- High beep tone is emitted when a switch is pushed for the sub band; the beep tone can be turned OFF if desired. (p. 45)
- Duplex, split and offset frequency setting cannot be performed.

■ Exchanging the main and sub bands

The function display shows both the main and sub band frequencies and both bands can receive signals simultaneously. Assign VHF or UHF, whichever band you want to transmit or be called on, as the main band.

- Push [M/S] to exchange the main and sub bands.

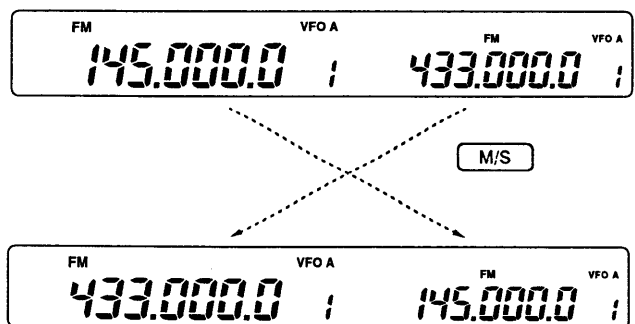

■ Accessing the sub band

Frequency control, memory operation and some functions can be operated on the sub band. You can search the sub band while standing by on the main band for quick response to received calls.

- ① Push [SUB] to access the sub band.
 - Turn the sub band ON in advance. (p. 19)
 - "SUB" appears on the function display.
 - You can transmit on the main band even when accessing the sub band.
- ② Push [SUB] again to return to the main band control.

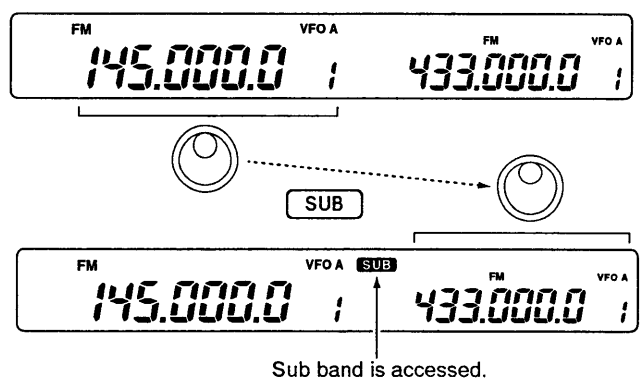

VFO description

The transceiver has two VFOs for both bands, specially suited for instant selection of 2 frequencies or split frequency operation. The VFOs are called VFO A and VFO B. You can use a desired VFO to call up a frequency and operating mode for your operation.

VFO is an abbreviation of Variable Frequency Oscillator, and traditionally refers to an oscillator.

CONVENIENT

Use two VFOs as a quick memory

When you find a new station but you wish to continue searching, the two VFO system can be used for quick memory storage.

- ① Push [FUNC] then [VFO•A=B] for 2 sec. to store the displayed frequency into the undisplayed VFO.
- ② Continue searching stations.
- ③ Push [VFO] to retrieve the stored frequency.
- ④ To continue searching stations, push [VFO] again.

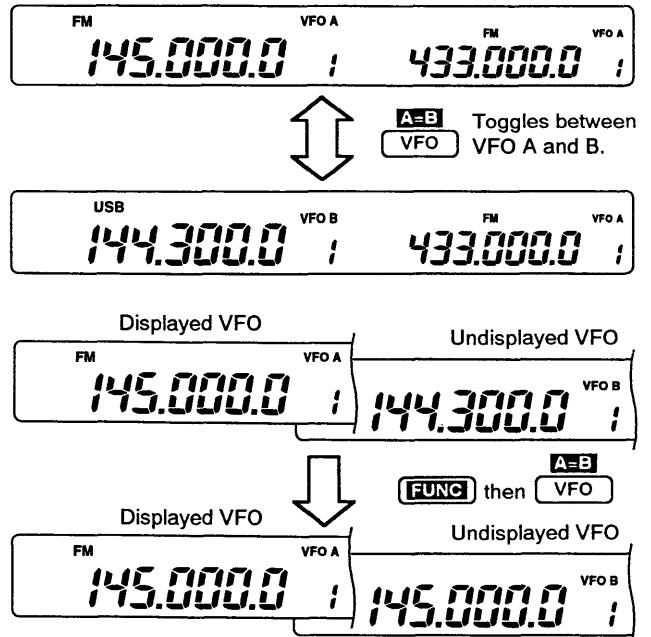

• The differences between VFO mode and memory mode

VFO MODE

Each VFO shows a frequency and operating mode. If the frequency or operating mode is changed, the VFO automatically memorizes the new frequency or new operating mode.

When a VFO is selected from another VFO or the memory mode, the last used frequency and operating mode for that VFO appear.

[EXAMPLE]

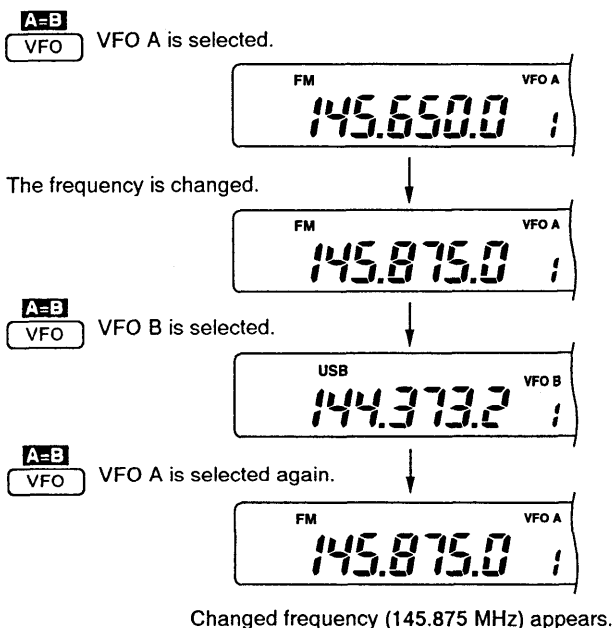

MEMORY MODE (pgs. 33-35)

Each memory channel shows a frequency and operating mode like a VFO. Even if the frequency or mode is changed, the memory channel does not memorize the new frequency or operating mode.

When the memory channel is selected from another memory channel or VFO mode, the memorized frequency and operating mode appear.

[EXAMPLE]

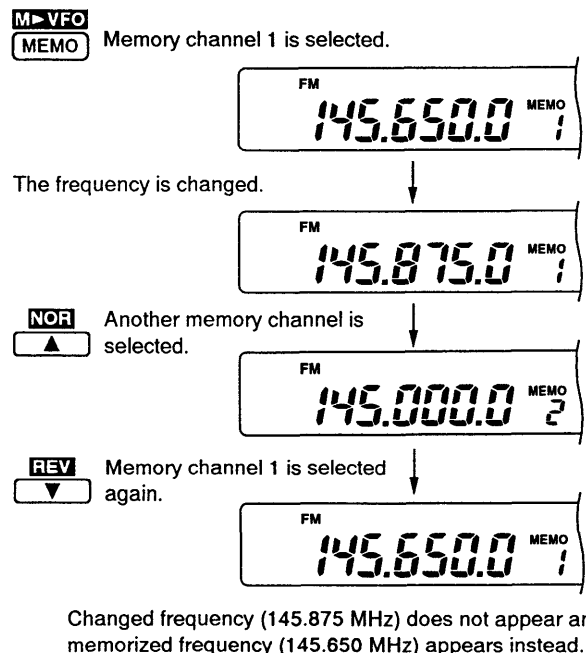

Frequency setting

The transceiver has a [kHz/MHz] switch and user-programmable tuning steps for convenient frequency tuning.

- ① Push [M/S] to select the desired frequency band as the main band; or push [SUB] to access the sub band.
- ② Push [VFO] to select VFO mode.
- ③ Rotate the tuning dial to set the frequency.
 - When SSB or CW mode is selected, the memory channel number changes to the 10 and 1 Hz digits when rotating the tuning dial except when the 100 Hz tuning step is selected. (This can be turned OFF in set mode. See p. 46.)
 - When you want to check the 10 and 1 Hz digits, push and hold [M/S].
 - When passing an initial frequency, a beep tone sounds. This is the spot frequency beep and can be programmed. (p. 24)

10 and 1 Hz DIGIT INDICATIONS (SSB/CW only)

When rotating the tuning dial or pushing [M/S] more than 1 sec.

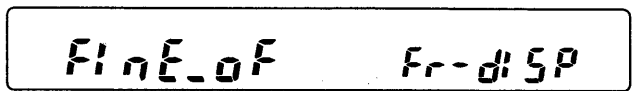
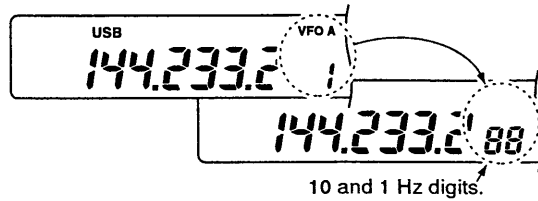

When you do not require the 10 and 1 Hz indications, set "FINE-of" in the [FUNC] set mode. (p. 46)

Quick tuning steps

The operating frequency can be changed in 1 kHz steps or 1 MHz steps for quick tuning.

- For 1 kHz tuning: Push [kHz/MHz] momentarily.

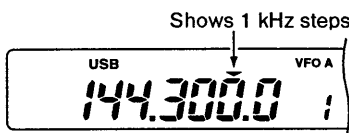

Push [kHz/MHz] again to return to the normal steps.

- For 1 MHz tuning: Push [kHz/MHz] for 2 sec.

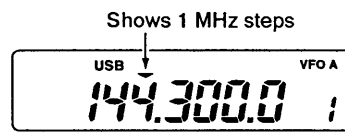

Push [kHz/MHz] again to return to the normal steps.

Tuning step selection

Tuning steps can be pre-set independently for FM and SSB/CW. The following steps are selectable.

- FM : 0.1, 5, 10, 12.5, 20, 25 or 100 kHz
- SSB/CW : 1, 10, 50 or 100 Hz

- ① Push [M/S] or [SUB] to select the desired band.
- ② Push [FM] or [SSB/CW] to select the desired operating mode.
- ③ Push [FUNC] then [SSB/CW•TS] to indicate the tuning step setting display.
- ④ Rotate the tuning dial to set the desired steps.
- ⑤ Push [SSB/CW] to return to the previous display.

For SSB/CW modes, the tuning step of the microphone [UP]/[DN] switch becomes 50 Hz when the tuning step is set less than 50 Hz.

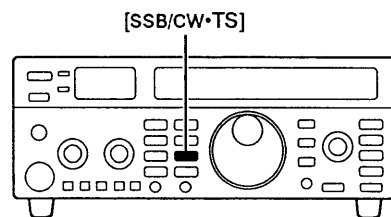

FM tuning step setting display (Unit: kHz)

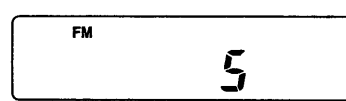

SSB/CW tuning step setting display (Unit: Hz)

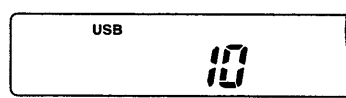

3 FREQUENCY SETTING

■ Mode selection

SSB (LSB/USB), CW, CW-N (CW narrow) and FM modes are available in the IC-821H. Select the desired mode as follows:

• Selecting FM mode

Push [FM] to select FM mode.

- When pushing [FM] twice, duplex and tone is turned ON simultaneously for the U.S.A. and Australia versions. See p. 31 for setting the duplex direction.

• Selecting SSB mode

Push [SSB/CW] one or more times to select USB mode.

- USB mode is generally used for SSB phone operation on the VHF and UHF bands.
- Pushing [SSB/CW] sequentially selects USB, LSB, CW and the optional CW-N mode.

• Selecting CW mode

Push [SSB/CW] one or more times to select CW or optional CW-N mode.

- Pushing [SSB/CW] sequentially selects USB, LSB, CW and the optional CW-N mode.
- An optional FL-132 or FL-133 CW NARROW FILTER is necessary to operate the CW-N mode for the main or sub band, respectively. In the satellite mode, an optional FL-133 is necessary to operate the CW-N mode in the main (receive) band. No audio is output until an optional CW narrow filter is installed in the CW-N mode.

■ Dial lock function

The dial lock function prevents accidental changes caused by the tuning dial (including the sub tuning dial function).

- Push [FUNC•LOCK] for 2 sec. to activate and cancel the dial lock function.

Even while the dial lock function is activated, memory channel selection can be made with the tuning dial while pushing the [MEMO] switch.

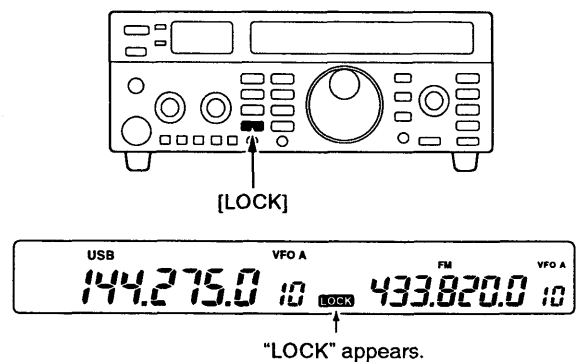

■ Sub band OFF

The sub band can be deactivated to simplify operation.

- Push [FUNC] then [SUB•SUB OFF] to toggle the sub band ON and OFF.

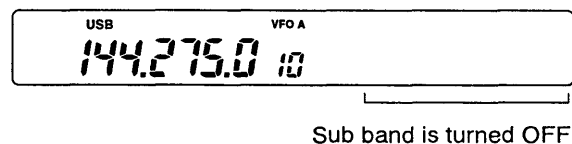

Sub tuning dial

The transceiver has a large main tuning dial for frequency setting. In addition, the [RIT] or [SHIFT] controls can be used as a sub tuning dial for dual band simultaneous tuning, etc. The sub tuning dial changes the operating frequency continuously at a variable speed.

To use the sub tuning dial function, assign the function to either the [RIT] or [SHIFT] control using the set mode with the [RIT] switch as described below.

▨ The assigned control can be used for its original function, however, both functions cannot be used simultaneously.

- ① Assign the function to the [RIT] or [SHIFT] control and the effect to the accessed band or sub band.
 - See the box below.
- ② Push [RIT] for 2 sec.
 - "RIT" blinks when the sub tuning dial function is activated.

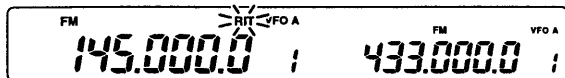

The display shows the assigned function is activated.

- ③ Set the [RIT] or [SHIFT] control for the desired tuning direction and speed.
 - Tuning speed can be adjusted in ± 5 steps.

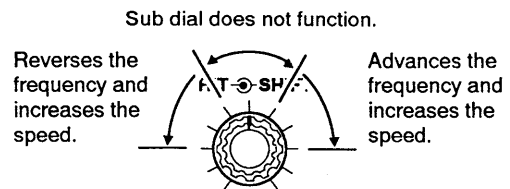

- ④ Push the [RIT] switch to cancel the function.

▨ While pushing the [MEMO] switch, the sub tuning dial changes the memory channel.

• Sub tuning dial function assignment

- ① Push [SPCH+SET] for 2 sec. to enter the set mode.
 - "SEt" appears.
- ② Push [RIT] to select the [RIT] or [SHIFT] control to be assigned.
 - "rit nob" or "SFt nob" appears.

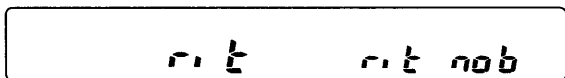

The [RIT] control functions as [RIT] even when the sub tuning dial function is activated. (default)

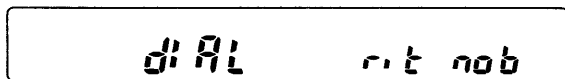

The [RIT] control can be used for main band tuning.

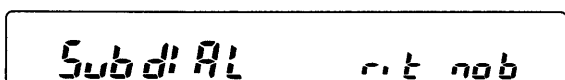

The [RIT] control can be used for sub band tuning.

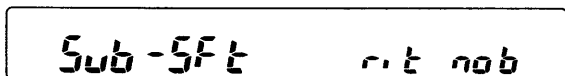

The [RIT] control can be used for sub band IF shift control. See the IF shift function for details. (p. 22)

- ③ Rotate the tuning dial to select the desired condition as described below.
- ④ Push [SPCH] to exit set mode.

▨ **NOTE:** When the same functions are assigned to the both [RIT] and [SHIFT], only the [RIT] control is functional.

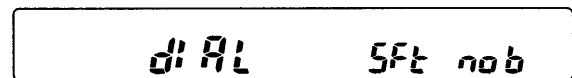

The [SHIFT] control can be used for main band tuning.

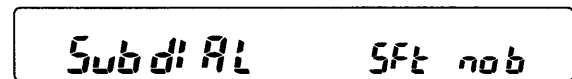

The [SHIFT] control can be used for sub band tuning.

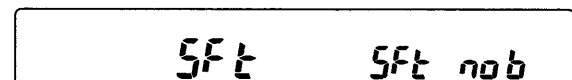

The [SHIFT] control functions as [SHIFT] even when the sub tuning dial function is activated. (default)

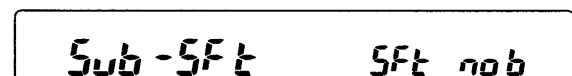

The [SHIFT] control can be used for sub band IF shift control.

4 RECEIVE AND TRANSMIT

■ Functions for receive

◇ Squelch setting

The squelch removes noise output from the speaker (closed condition) when no signal is received. The squelch is particularly effective for FM. It is also available for other modes.

• When operating in FM

- ① Rotate [SQL] fully counterclockwise.
- ② Rotate [SQL] clockwise to the point where the noise just disappears.

▨ The squelch does not open for weak signals when it is set too deep (clockwise).

• When operating in SSB or CW

- ① Rotate [SQL] fully counterclockwise.
 - The squelch opens. Under normal conditions, operate the transceiver in this position.
- ② Rotate [SQL] clockwise when you want to eliminate the floor noise if desired.

▨ The SSB threshold point can be set to the 9 or 12 o'clock position in set mode with the [CHECK] switch. When setting to the 12 o'clock position, the signal strength to open the squelch is nearly equal for FM and SSB/CW modes. (p. 45)

◇ Frequency check

The frequency check function opens the squelch and monitors the frequency to be transmitted without changing the squelch setting level.

This function is useful while operating in FM mode, operating through a repeater (p. 31) or operating with the split function (p. 26).

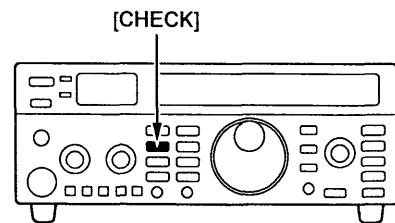

◇ RIT function

The RIT (Receive Incremental Tuning) function compensates for off-frequencies of communicating stations. The function shifts the receive frequency up to ± 1.0 kHz in 10 Hz steps in SSB/CW mode (± 5.0 kHz in 50 Hz steps in FM mode) without moving the transmit frequency.

The RIT function can be used for the main band only. The function affects to the main band even when accessing the sub band.

- ① Push the [RIT] switch to activate the function.
 - "RIT" appears.

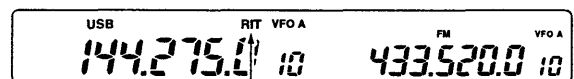

- ② Rotate the [RIT] control to cancel the off-frequencies.
 - The transmit frequency is not shifted.
- ③ To cancel the RIT function, push [RIT] again.
 - "RIT" disappears.

◇ IF shift function

The IF shift function electronically changes the pass-band frequency of the IF (Intermediate frequency) and cuts out higher or lower frequency components of the IF to reject interference. The function shifts the IF frequency up to ± 1.2 kHz in 100 Hz steps in SSB/CW mode. The IF shift is especially effective in SSB operation and not available in FM mode.

The IF shift function can be used for the sub band using the sub tuning dial function. (p. 20)

• Main band IF shift operation

- ① Adjust the [SHIFT] control for a minimum interference signal level.
 - The audio tone may change while the IF shift is in use.
- ② Set the [SHIFT] control to its center position when there is no interference.

• Sub band IF shift operation

- ① Assign the sub band IF shift function to the [RIT] or [SHIFT] control using set mode with [RIT].
- ② Push [RIT] for 2 sec. to activate the sub tuning dial function.
- ③ Adjust the [RIT] or [SHIFT] control for a minimum interference signal level.
- ④ Push [RIT] to cancel the sub tuning dial function.
 - Set the [SHIFT] control to center when [SHIFT] is used.

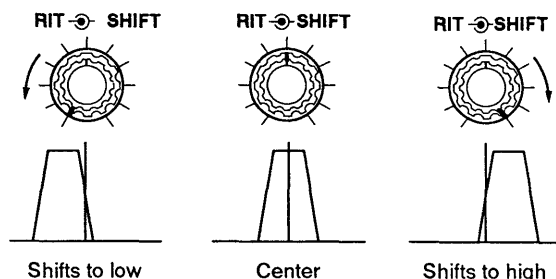

▨ The IF shift function can be used in both bands when the sub IF shift is assigned to the [RIT] control for the sub tuning dial function. (p. 20)
 When rotating the [SHIFT] control, especially in CW mode, a mechanical sound may be heard. Don't be alarmed, this is normal and is not a transceiver malfunction.

◇ Noise blanker

When operating SSB or CW mode, pulse-type noise may be received, such as from car ignitions. In this case, the noise blanker eliminates such noise.

The noise blanker is effective on both bands but cannot be used for FM, or non-pulse-type noise.

- Push [NB] to toggle the noise blanker ON and OFF.
 - The noise blanker turns ON or OFF for both bands simultaneously.

▨ **NOTE:** When using the noise blanker, received signals may be distorted if they are excessively strong.

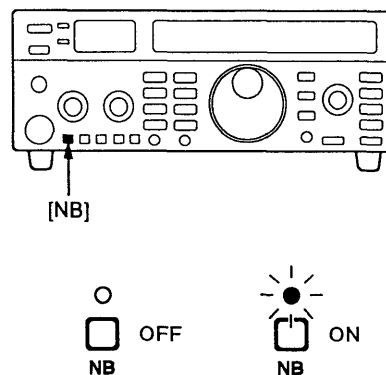

◇ AGC time constant

The AGC (Automatic Gain Control) controls receiver gain to produce a constant audio output level even when the received signal strength is varied by fading, etc. Use AGC slow for normal phone operation; AGC fast for receiving data and searching for signals.

- Push [AGC] to toggle the AGC time constant between slow and fast.
 - The AGC time constant is fixed in FM mode.

▨ The sub band's AGC is automatically selected as slow in SSB and fast in CW. AGC time constant cannot be changed in FM mode.

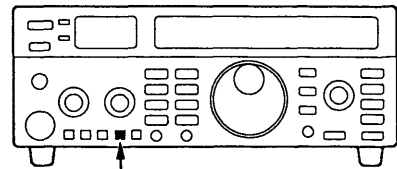

[AGC]



SLOW
AGC

FAST
AGC

◇ Attenuator and optional preamp

The attenuator prevents desired signals from distorting when very strong signals are near the desired frequency or when very strong electric fields, such as from broadcasting stations are near your location.

- Push [ATT] to toggle the attenuator ON and OFF.
 - The attenuation level is approx. 15 dB for each band.
 - The attenuator can be used on one band or both bands using set mode with the [ATT] switch. (p. 49)

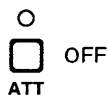

OFF
ATT



ON
ATT

The optional preamplifier, AG-25 or AG-35, amplifies received signals near the antenna to improve the S/N ratio, sensitivity and cable loss. Turn the preamplifier ON when receiving weak signals.

- Push [PREAMP] to toggle the preamplifier ON and OFF.
 - The preamplifier can be used on one band, both bands or neither using set mode with the [PREAMP] switch. (p. 49)

▨ The transceiver applies DC voltage to the antennas when this switch is turned ON. Therefore, this switch should be set to OFF when no preamplifier is connected.

◇ FM center indicator

The RX indicators indicate the received signal deviation in FM mode. When an off-center signal is received, the RX indicator flashes.

When an off-center signal is received, rotate the tuning dial or use the RIT function to light the RX indicator continuously.

The FM center meter can be turned OFF using set mode with the [FM] switch if desired. See p. 47 for setting the FM center meter ON and OFF.

Flashes when an off-center signal is received.

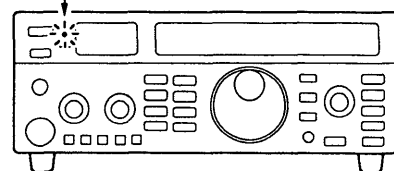

◇ Spot function

The spot function allows you to conveniently mark or store a DX station calling frequency temporarily. When tuning across the memorized frequency, a beep sounds to alert you. The spot frequency can be programmed for each band.

This function can be turned OFF using set mode with the [kHz/MHz] switch. (p. 48)

• Programming a frequency

- ① Select VFO mode.
- ② When a frequency to be marked appears, push [FUNC] then [kHz/MHz•SPOT].
- ③ Operate on other frequencies.
- ④ Rotate the tuning dial to return to the frequency.
- A beep tone is emitted when tuning across the frequency.

• Programming a memory channel

This function is also used for memory channel selection assistance such as an often-used memory channel or memory channel 1, etc.

- ① Select memory mode.
- ② Select the desired channel to be marked.
- ③ Push [FUNC] then [kHz/MHz•SPOT] to program.
- ④ Operate on other channels.
- ⑤ Push [▼]/[▲] to return to the channel.
- Two beep tones are emitted at the memory channel. (one beep tone for other channels)
- One beep tone is emitted when selecting the memory channel using the tuning dial with [MEMO].

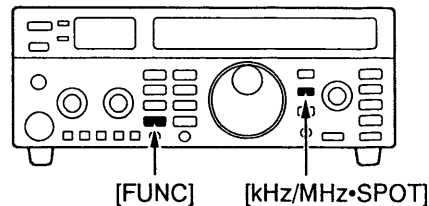

◇ Optional tone squelch operation

To operate the tone squelch, an optional UT-84 is required. See p. 51 for installation.

The tone squelch opens only when receiving a signal with the same pre-programmed subaudible tone. You can silently wait for a call from group members using the same tone. You can check the tone frequency using the tone scan if desired. (p. 32)

- ① Select the desired band with the [M/S] switch.
- ② Select FM mode, then set the desired frequency.
- ③ Push [FUNC] then [TONE•T SQL] to turn the tone squelch ON.
- "T-SQL" appears.
- ④ Program the tone squelch frequency as at right.
- ⑤ When the received signal includes the correct tone, the squelch opens and the signal can be heard.
- When the received signal includes an incorrect tone or no tone, the squelch does not open, however, the S-meter indicates the signal strength.
- To open the squelch manually, push and hold [CHECK].
- ⑥ Operate the transceiver in the normal way (push [PTT] to transmit; release [PTT] to receive).
- ⑦ To cancel the tone squelch, push [FUNC] then [TONE•T SQL].

• Setting the tone squelch frequency

Frequencies can be independently set for each band.

- ① Push [FUNC] then [TONE•T SQL] to activate the tone squelch.
- ② Push [SPCH•SET] for 2 sec. to enter set mode.

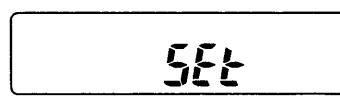

- ③ Push [TONE] to select the tone squelch frequency setting display.

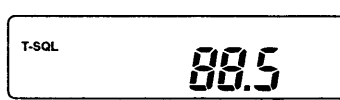

- ④ Rotate the tuning dial to select the desired frequency.
- ⑤ Push [SPCH] to exit set mode.

• Subaudible tone frequency list

(Unit: Hz)

67.0	82.5	100.0	123.0	151.4	171.3	189.9	210.7	250.3
69.3	85.4	103.5	127.3	156.7	173.8	192.8	218.1	254.1
71.9	88.5	107.2	131.8	159.8	177.3	196.6	225.7	
74.4	91.5	110.9	136.5	162.2	179.9	199.5	229.1	
77.0	94.8	114.8	141.3	165.5	183.5	203.5	233.6	
79.7	97.4	118.8	146.2	167.9	186.2	206.5	241.8	

■ Functions for transmit

◇ Output power and mic gain

The transmit power can be continuously adjusted with [RF PWR].

AVAILABLE POWER

BAND	FM/CW	SSB
VHF	6-45 W	6-35 W
UHF	6-40 W	6-30 W

• Setting microphone gain

Microphone gain must be adjusted properly so that your signal does not distort when transmitted.

DURING FM OPERATION

Preset [MIC] to the 10-12 o'clock position when using the HM-12 HAND MICROPHONE.

DURING SSB OPERATION

While transmitting and speaking into the microphone, rotate [MIC] so that the TX indicator periodically lights up brightly.

- The brightness increases when the ALC circuit is activated.

The brightness increases when the ALC circuit is activated.

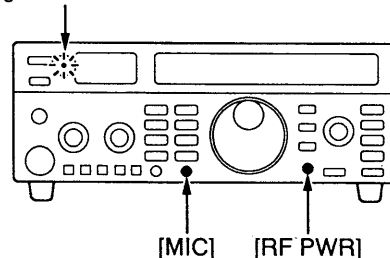

▨ The ALC circuit automatically limits RF output power by controlling the input level of the RF power amplifier. This prevents transmission of distorted signals when the input signal level exceeds the allowable level.

◇ Speech compressor

The IC-821H has a built-in, low distortion speech compressor circuit. This circuit increases your average talk power in SSB mode and is especially useful for DX'ing when the receiving station is having difficulty copying your signal.

- ① Select USB or LSB mode.
- ② Adjust the mic gain.
 - While transmitting at your normal voice level, the TX indicator periodically lights up brightly.
- ③ Push the [COMP] switch to turn the speech compressor ON.
 - The [COMP] indicator lights up.
- ④ Adjust the [COMP/KEY] control so that the TX indicator periodically lights up brightly whether you speak softly or loudly.
 - The [COMP/KEY] control is commonly used for the electronic keyer's speed in CW mode.

The brightness increases when the ALC circuit is activated.

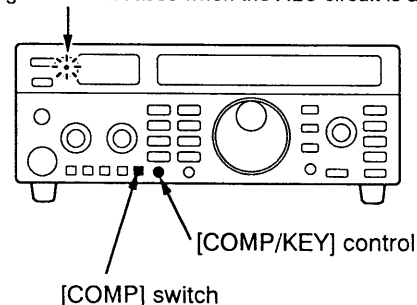

▨ When the TX indicator continuously light up brightly, your transmitted voice may be distorted.

◇ Split frequency operation

Split frequency operation allows you to transmit and receive on two different frequencies (in the same band). Split frequency operation uses 2 frequencies, one in VFO A and the other in VFO B.

- ① Set a receive frequency in VFO mode.
 - Either VFO A or VFO B can be used.

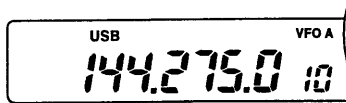

- ② Push [FUNC] then [VFO•A=B] for 2 sec.
 - The undisplayed VFO contents are cleared and equalized to the displayed frequency.
- ③ Push [FUNC] then [CALL•SPLIT].
 - Now you can receive on the displayed VFO and transmit on the undisplayed VFO.

"SPLIT" appears.

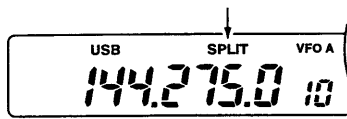

- ④ To change the receive frequency, rotate the tuning dial.
- ⑤ To replace the transmit and receive frequencies, push [VFO] to exchange VFOs.
- ⑥ To change the transmit frequency, rotate the tuning dial while pushing [CHECK].

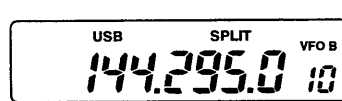
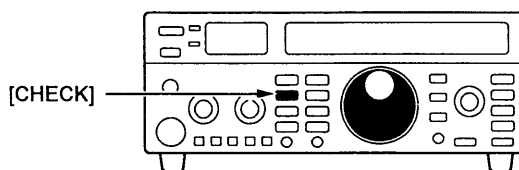

Transmit frequency (another VFO) appears and can be adjusted.

- ⑦ Push [FUNC] then [CALL•SPLIT] to cancel.
 - "SPLIT" disappears.

▨ Cross mode communication can be performed using the split function. (e.g. USB and CW)

◇ Crossband full duplex

The transceiver can receive a sub band signal while transmitting on the main band. Using this capability, crossband full duplex operation is possible.

To prevent howling, set the volume level as low as possible.

- ① Set sub band audio to output during transmit.
 - Push [SPCH•SET] for 2 sec.
 - Push [SUB] twice to select "audio."
 - Rotate the tuning dial to turn the sub band audio ON (output).

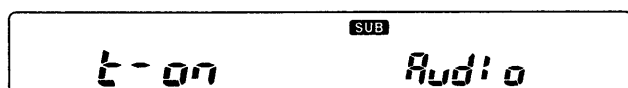

Sub band audio is output while transmitting. (default)

- ② Select the transmit band with the [M/S] switch.
- ③ Set the transmit frequency.
 - Select VFO mode with the [VFO] switch.
 - Rotate the tuning dial to set the transmit frequency.

- ④ Set the receive frequency.
 - Select the sub band with the [SUB] switch.
 - Select VFO mode with the [VFO] switch.
 - Rotate the tuning dial to set the receive frequency.
- ⑤ Set the same frequencies, but set your sub band as the main (transmit) band for the other transceiver.
- ⑥ Push and hold [PTT] to operate in full duplex.
 - Transmit and receive activate simultaneously.

▨ Be sure "SPLIT," "SATL-N" or "SATL-R" do not appear.

- To turn the split function OFF, push [FUNC] then [CALL•SPLIT].
 - To turn the satellite function OFF, push [FUNC] then [▼•REV] or [▲•NOR].

■ Functions for CW

◇ Connections for CW

[KEY]

Paddle

Straight key

[MIC]

Microphone

Before operating in CW, select the keyer type using set mode with the [SSB/CW] key.

- Push [SPCH•SET] for 2 sec., then push [SSB/CW] 3 times. Rotate the tuning dial to make a selection.

[SET MODE SETTING (PADDLE)]

CW paddle (normal polarity; default)

CW paddle (reverse polarity)

Electronic keyer OFF (straight key)

NOTE: A stereo plug must be used even when a straight key is used. See p. 11.

Substitute paddle function (microphone [UP]/[DN])

NOTE: Only "dots" are emitted when pushing the [UP]/[DN] switch simultaneously. [UP]/[DN] keys do not function as up/down keys in this case.

◇ CW operation

- ① Connect a paddle or straight key as above.
- ② Select CW or optional CW-Narrow mode with [SSB/CW].
 - When an optional CW narrow filter is not installed, no audio is output in CW-N mode.
- ③ Set CW semi break-in operation ON or OFF.
 - Push [SPCH•SET] for 2 sec.
 - Push [SSB/CW] once to select "br-in."
 - Rotate the tuning dial to turn the function ON or OFF.
- ④ Operate the paddle or key to transmit the CW signal.
 - Adjust the [COMP/KEY] control to set the keying speed when using a paddle with the internal electronic keyer.
 - Adjust [DELAY] on the rear panel to your desired switching speed for returning transmit to receive when turning the semi break-in function ON.
 - Push [TRANSMIT] IN before transmit when turning the semi break-in function OFF.

Semi break-in is turned ON. (default)

◇ **Electronic CW keyer**

The IC-821H has an electronic keyer. Both keying speed and weight (the ratio of dot : space : dash) can be adjusted in set mode with the [SSB/CW] switch.

• **Setting the electronic keyer**

- ① Push [SPCH•SET] for 2 sec. to enter set mode.



- ② Push [SSB/CW] twice to select the CW side tone setting display, then rotate the tuning dial to select the side tone level control.

- When "nor" (normal) is selected, the CW side tone level is controlled by [CW SIDE TONE] on the rear panel only. When "USEr" is selected, the CW side tone level is controlled by [CW SIDE TONE] and [AF].

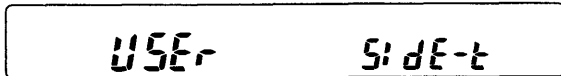
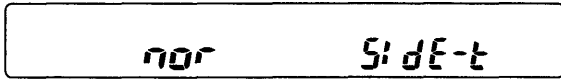

- ③ Push [SSB/CW] one more time to select the CW keyer setting display, then rotate the tuning dial to select the keyer type.

- Be sure "OFF" is not selected, otherwise, the internal electronic keyer cannot be used.
 - See the opposite page for details.



- ④ Push [SSB/CW] one more time to select the keying weight setting display, then rotate the tuning dial to select the ratio.

- Key weight can be selected from 2.8 to 4.5.
 - Check the selected ratio with the side tone function in CW mode.



- ⑤ Push [SPCH] to exit set mode.

KEYING WEIGHT EXAMPLE "morse code K"

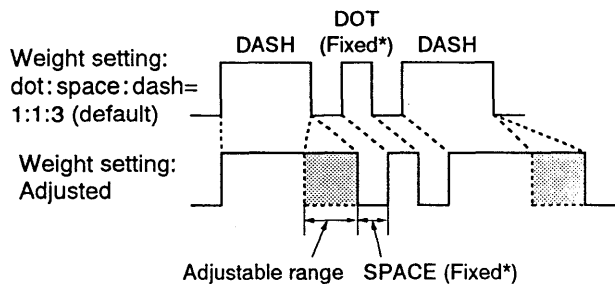

* SPACE and DOT length can be adjusted with [COMP/KEY] only.

■ Functions for AFSK

The transceiver does not have an FSK mode for RTTY, AMTOR, PACKET, etc., however, you can operate these using AFSK in SSB or FM mode.

The transceiver accepts data speeds of up to 9600 bps. When using 9600 bps, set the transceiver to 9600 bps data mode using set mode with the [M/S] switch. (p. 43)

When operating AFSK, connect external equipment to the ACC socket on the rear panel or to the microphone connector on the front panel as in the diagram below.

When connected to the [MIC] connector, [MIC] and [AF] control adjustments are required. The [MIC] connector accepts up to 1200 bps.

OPERATION NOTES FOR 9600 bps

- Set the transceiver to 9600 bps data mode.
 - See "Setting the ACC socket" for selection.
- Set the GMSK output level of the terminal unit to 1.0 V p-p (350 mV rms).
 - When exceeding 1.6 V p-p, the transceiver's modulation input limiter stops modulation.
 - At this time, the [TX] indicator's brightness fades.
- AF output from the transceiver is continuous and is not cut by the squelch circuit.

◇ Connections for AFSK

Connections via rear panel (for 9600 bps or 1200 bps operation)

Use FM mode for 9600 bps operation.
Use SSB or FM mode for 1200 bps operation.

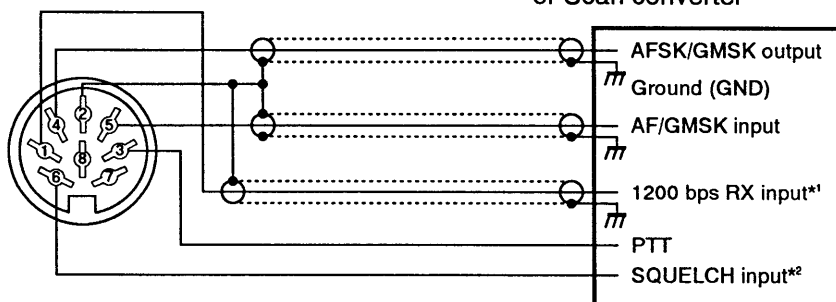

[ACC(1)] socket
(Rear panel view)

*1 Some 9600 bps TNCs have this terminal. Connect the 1200 bps RX input when required.

*2 Connect the SQUELCH line when required.

Remove the ACC plug or turn the TNC power OFF during phone operation. The modulation input from the ACC socket is always applied to the modulation circuit.

Connections via front panel (for 1200 bps operation only)

Use SSB or FM mode for operation.

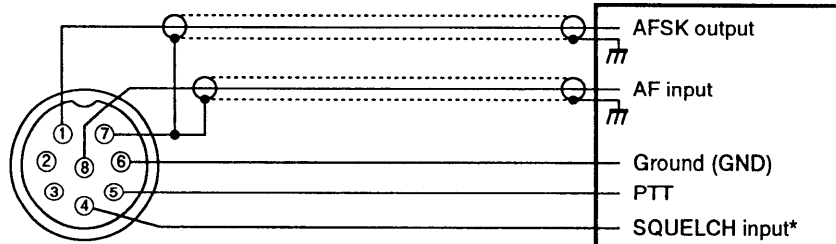

[MIC] connector
(Front panel view)

* Connect the SQUELCH line when required.

When connected to the [MIC] connector, [MIC] and [AF] control adjustment is required.

◇ AFSK operation

Connect external equipment to the ACC socket as described on the opposite page. Set the ACC socket using set mode with the [M/S] switch in advance. (See below.)

- ① Select LSB, USB or FM.
 - LSB is normally used.
 - FM is used for PACKET.
- ② Adjust the audio output level with [AF].
 - Use [SQL] when required.
- ③ Adjust the desired RF output power.
 - When using the [MIC] connector for external equipment connection, the [MIC] control should be adjusted.
- ④ Control the transceiver from the connected PC or TNC (TU).

• **Operating notes for RTTY and AMTOR**
RTTY or AMTOR operating frequency in LSB mode differs from the displayed frequency.

[Your operating freq.] = [Displayed freq.] – 2125 Hz

(when the frequencies of the RTTY demodulator in your TNC or TU are mark=2125 Hz and space=2295 Hz).

• **Operating notes for PACKET**

PACKET operating frequency in LSB mode differs from the displayed frequency.

[Your operating freq.] = [Displayed freq.] – 2215 Hz

(when the frequencies of the PACKET demodulator in your TNC are 2115 Hz/2315 Hz).

• **Frequency setting example for AFSK**

- When operating RTTY at 144.090 MHz:

Set "LSB 144.092125 MHz" (if you use mark=2125 Hz/space= 2295 Hz).

- When operating PACKET at 144.110 MHz:

Set "LSB 144.112215 MHz" (if you use 2115 Hz/2315 Hz).

◇ Setting the ACC socket

When operating AFSK, set the specifications of the ACC socket to fit your TNC or scan converter in advance.

- ① Push [SPCH•SET] for 2 sec. to enter set mode.

The LCD display shows the word "SET" on the left and the frequency "433.520.0" on the right. Above the frequency, "FM" is displayed, and "VFO A" is in the top right corner.

- ② Push [M/S] once to select 9600 bps data mode setting display, then rotate the tuning dial to select 9600 or 1200 bps.

- Specifications of the ACC socket (pins 1, 4 and 5) are changed. See p. 9 for details.

The LCD display shows the word "off" on the left and the number "9600" on the right.

- ③ Push [M/S] one more times to select the ACC socket pins 1, 5 and 6 setting display, then rotate the tuning dial to make a selection.

- When "nor" (normal) is selected, the ACC socket (pins 1, 5 and 6) outputs main band signals. When "Sub" is selected, the ACC socket (pins 1, 5 and 6) outputs sub band signals.

NOTE: Select "nor" (normal) when operating data mode in satellite mode.

The LCD display shows the word "nor" on the left and "ACC P5.6" on the right.

- ④ Push [M/S] two more times to select the modulation input sensitivity setting display, then rotate the tuning dial to make a selection.

- HI: 100 mV Lo: 2 mV

- This setting is ignored when 9600 bps data mode (②) is selected and 1.0 Vp-p is set as a fixed value.

The LCD display shows the word "HI" on the left and "ACC-AF" on the right.

- ⑤ Push [SPCH] to exit set mode.

5 FM REPEATER USE

Operation

A repeater amplifies received signals and transmits them at a different frequency. When using a repeater, the transmit frequency is shifted from the receive frequency by the offset frequency as below. It is convenient to program repeater information into a memory channel. (p. 34)

- ① Select the desired band as the main band with the [M/S] switch.
- ② Push [FM] to select FM mode.
- ③ Set the receive frequency (repeater output frequency).
- ④ Push [FUNC] then [FM•DUP] to select – duplex or push them again for + duplex.
 - "DUP –" or "DUP +" appears to indicate the transmit frequency for minus shift or plus shift, respectively.
 - The U.S.A. and Australia versions have an auto repeater function. (next page)

- For the U.S.A. and Australia versions, one-touch repeater is available. Push [FM] to set the pre-programmed duplex direction and to turn the sub-audible tone encoder ON. See the next page.
- ⑤ Push and hold [PTT] to transmit.
 - The displayed frequency automatically changes to the transmit frequency (repeater input frequency).
 - When the repeater requires a tone, see the section below.
 - Push and hold [CHECK] to check whether the other station's transmit signal can be directly received or not.
- ⑥ Release [PTT] to receive.
- ⑦ To return to simplex, push [FUNC] then [FM•DUP] once or twice to clear the "DUP" indicator.
 - For the U.S.A. and Australia versions, push [FM] once or twice to cancel the "DUP" and "T" settings.

Tone information

SUBAUDIBLE TONE

(U.S.A. and Australia versions only)

- ① Push [TONE] to turn the subaudible tone encoder ON.
- ② Set the tone frequency if desired.
 - Push [SPCH•SET] for 2 sec.

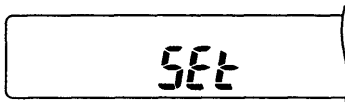

Set mode is selected.

- Push [TONE].

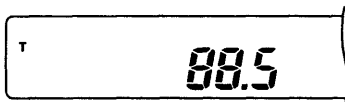

Tone encoder frequency appears.

- Rotate the tuning dial to select the desired tone frequency.
- Push [SPCH] to exit set mode.

- ③ Push [TONE] to turn the subaudible tone encoder OFF.

• Subaudible tone frequency list

(Unit: Hz)

67.0	82.5	100.0	123.0	151.4	171.3	189.9	210.7	250.3
69.3	85.4	103.5	127.3	156.7	173.8	192.8	218.1	254.1
71.9	88.5	107.2	131.8	159.8	177.3	196.6	225.7	
74.4	91.5	110.9	136.5	162.2	179.9	199.5	229.1	
77.0	94.8	114.8	141.3	165.5	183.5	203.5	233.6	
79.7	97.4	118.8	146.2	167.9	186.2	206.5	241.8	

DTMF TONES (HM-14 is required.)

Push the desired digit keys on the microphone in sequence to transmit DTMF tones.

1750 Hz TONE (Europe and Sweden versions only)
Push [TONE] for 1–3 sec. to transmit a 1750 Hz tone call signal.

Offset frequency

Frequencies can be independently set for each band. Set the desired offset frequency as follows:

Appears when 1 kHz or 1 MHz tuning step is selected.

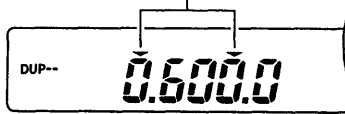

The display shows a 0.6 MHz (600 kHz) offset frequency.

- ① Select the desired band as the main band with the [M/S] switch.
- ② Push [FUNC] then [FM•DUP] to select duplex.

- ③ Push [SPCH•SET] for 2 sec. to enter set mode.
- ④ Push [FM] once or twice to select the offset frequency setting display.
- ⑤ Rotate the tuning dial to select the desired frequency.
 - Selectable step increment is the same as the preset tuning step in FM mode. (p. 18)
 - 1 kHz tuning step is selected in SSB/CW mode.
 - Use [kHz/MHz] for quick frequency setting.
- ⑥ Push [SPCH] to exit set mode.

■ One-touch repeater (U.S.A. and Australia versions only)

The U.S.A. and Australia version's repeater settings (DUP+ or DUP- and tone encoder ON) can be activated by simply pushing [FM] in FM mode.



The display shows -duplex is selected for the one-touch repeater function.

The duplex direction setting is common for each band. Set the desired duplex direction as follows:

- ① Push [SPCH•SET] for 2 sec. to enter set mode.
- ② Push [FM] once to select the one touch repeater setting display.
- ③ Rotate the tuning dial to select the desired duplex direction.
- ④ Push [SPCH] to exit set mode.

■ Optional tone scan

By monitoring a signal that is being transmitted on a repeater input frequency, you can determine the tone frequency necessary to open a repeater. The tone scan can be used in both bands and an optional UT-84 is required.

- ① Select FM mode with the [FM] switch.
- ② Set the desired frequency to be checked for a tone frequency. (e.g. repeater input frequency)
- ③ Activate the tone encoder or tone squelch.
- ④ Push [SCAN] for 2 sec. to start the tone scan.

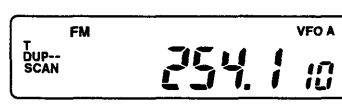

The operating frequency changes to the tone frequency.

- ⑤ When the tone frequency is matched, the scan pauses with a beep and the tone frequency is programmed into the set mode contents of the subaudible tone or tone squelch frequency.
 - The tone frequency is temporarily changed when scanning on a memory or call channel.
- ⑥ Push [SCAN] to stop the tone scan.
 - When the scan resume function is cancelled using set mode with [SCAN], the tone scan is cancelled when the tone frequency is matched. (p. 49)

■ Auto repeater function (U.S.A. and Australia versions only)

The U.S.A. and Australia versions automatically activate repeater settings (DUP+ or DUP- and tone encoder ON/OFF) when the operating frequency falls within the general repeater frequency range and deactivates them when outside of the range. See p. 47 for auto repeater selection.

▨ The repeater range can be programmed by the following procedure only. The ranges remain even when the CPU is reset. (p. 15)

• Programming a repeater frequency range

The U.S.A. and Australia versions can have 3 repeater output frequency ranges set for each band. For the U.S.A. version, the general repeater frequency ranges (right) are set by default.

- ① Program the desired lower repeater output frequency edge and duplex direction (DUP- or DUP+) into memory channel 1. (p. 34)
- ② Program the desired higher repeater output frequency edge into memory channel 2.

- ③ Program the other frequency edges into memory channels 3/4 and 5/6 in a similar manner.
 - If you do not require more ranges, be sure that memory channel 3 and/or 5 are set to simplex.
- ④ Program the other band edges referring to ①-③.
- ⑤ Turn power OFF, then turn power ON while pushing [FM] and [TONE] to program the ranges.

▨ After programming, the memory channels can be changed and the ranges do not change if the contents are changed.

• Default repeater frequency ranges and offset directions of the U.S.A. version

FREQUENCY RANGE	DUPLEX DIRECTION
145.2000-145.4999 MHz 146.6100-146.9999 MHz	"DUP -" appears.
147.0000-147.3999 MHz	"DUP +" appears.
442.0000-444.9999 MHz	"DUP +" appears.
447.0000-449.9999 MHz	"DUP -" appears.

6 MEMORY MODE

Memory channels

The transceiver has a total of 160 memory channels. Each memory channel can be used to store often-used frequencies and operating modes as well as a tone frequency, offset frequency, etc.

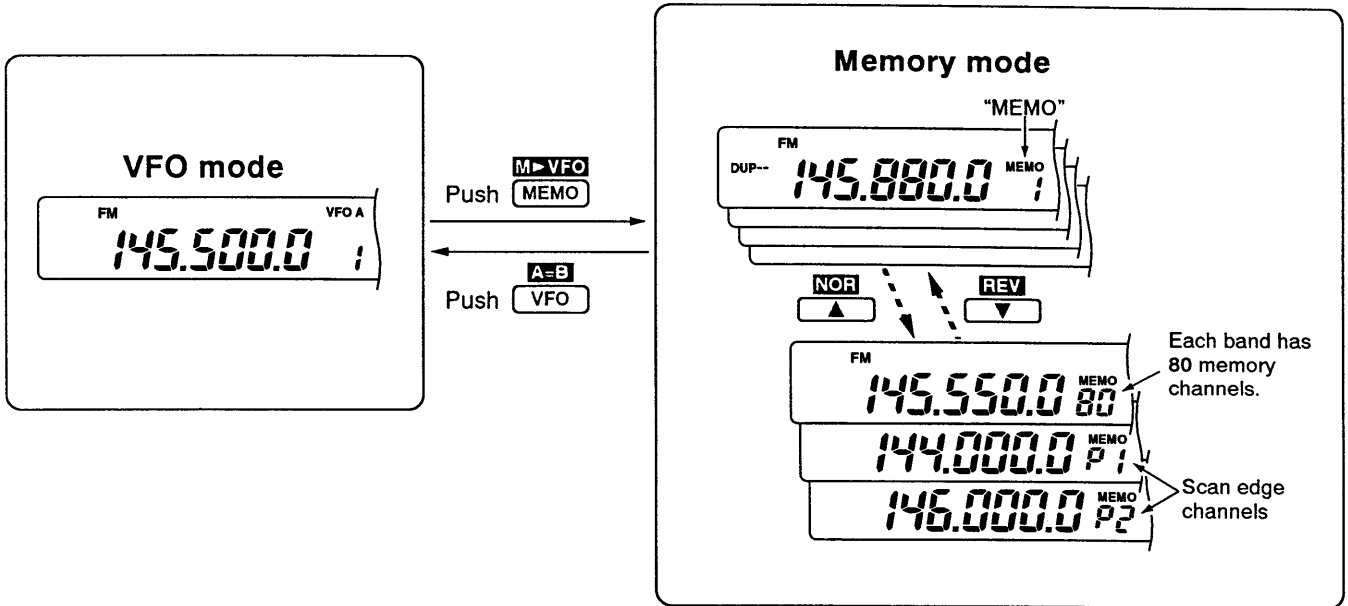

Operation on a memory channel

- Frequency and mode, etc. can be changed in a memory channel. However, they will be cleared if [MW] is not pushed.

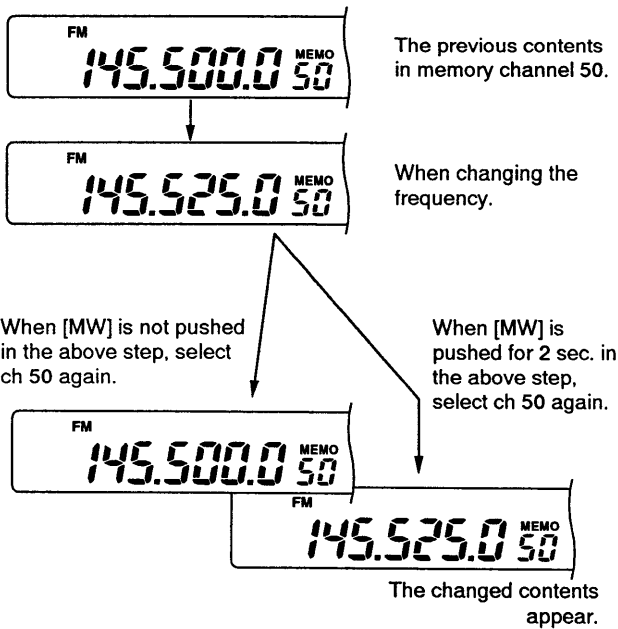

- Memory channel 6 and channels above have no contents programmed. The following indication appears after 2 sec. when selecting these channels.

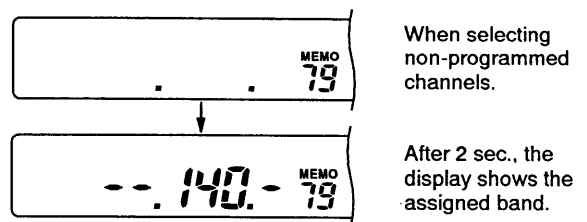

- A beep tone sounds when changing the memory channel. 2 beep tones sound when spot memory channel is selected.

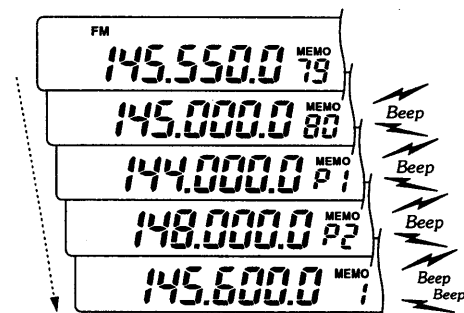

2 beeps sounds on the spot memory channel. (p. 24)

Memory channel selection

- ① Push [MEMO] to select memory mode.
- "MEMO" appears.
- ② Push [▲] or [▼] to select the desired memory channel.
- The tuning dial can also be used for memory channel selection. While pushing [MEMO], rotate the tuning dial.
- ③ To return to VFO mode, push [VFO].

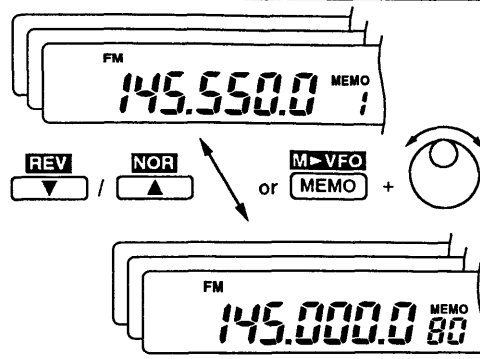

Memory channel programming

Memory channel programming can be performed either in VFO mode or in memory mode.

• Programming in VFO mode

- ① Set the desired frequency and operating mode in VFO mode.
- Tone frequency, offset frequency, etc., can also be programmed.
- ② Push [▲] or [▼] to select the desired memory channel to be programmed.
- The tuning dial can also be used while [MEMO] is pushed.
- ③ Push [MW] for 2 sec. to program the displayed frequency and operating mode into the memory channel.

To check the programmed contents, push [MEMO] to select memory mode.

[EXAMPLE] : Programming 144.275 MHz/USB into memory channel 12.

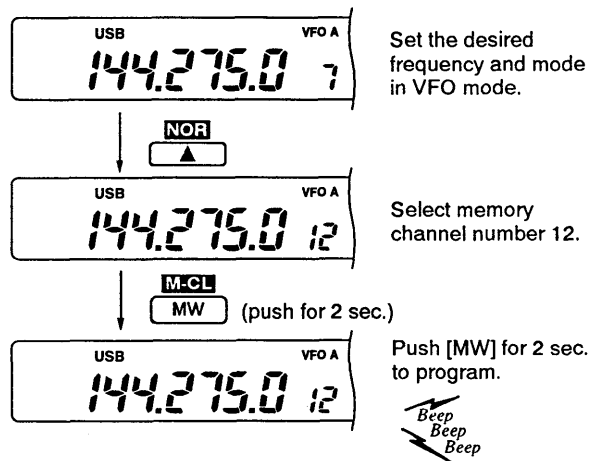

• Programming in memory mode

- ① Push [MEMO] to select memory mode.
- ② Select the desired memory channel to be programmed with the [▲] or [▼] switch.
- The tuning dial can also be used while [MEMO] is pushed.
- ③ Set the desired frequency and operating mode in the memory mode.
- Tone frequency, offset frequency, etc., can also be programmed.
- Blank channels cannot be programmed in the memory mode. Select the VFO mode in advance, then program blank channels.
- ④ Push [MW] for 2 sec. to program the displayed frequency and operating mode into the memory channel.

[EXAMPLE] : Programming 145.750 MHz/FM into memory channel 18.

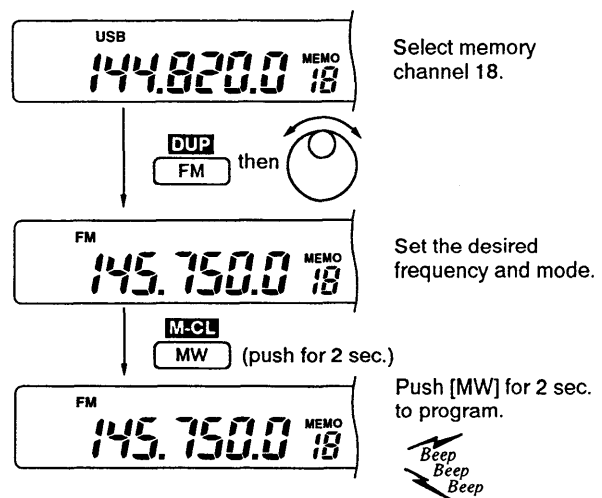

Transferring memory contents

This function transfers the memory channel contents into a VFO. This is useful to call up the subaudible tone frequency, offset frequency, etc., to the VFO.

NOTE: When you have changed the frequency and mode in the selected memory channel:
 - **Displayed** frequency/mode are transferred.
 - **Programmed** frequency/mode are not transferred, and they remain in the memory channel.

- ① Push [MEMO] to select memory mode.
 - This function cannot be activated from VFO mode.
- ② Select a memory channel with the [▲] or [▼] switch.
 - The tuning dial can also be used while [MEMO] is pushed.
- ③ Push [FUNC] then [MEMO·M▶VFO] for 2 sec. to transfer the contents of the memory channel.
 - The contents are transferred to the most recently used VFO (VFO A or VFO B).

TRANSFERRING EXAMPLE

Operating frequency : 144.028 MHz/CW (MEMO 19)
 Previously used VFO : VFO A

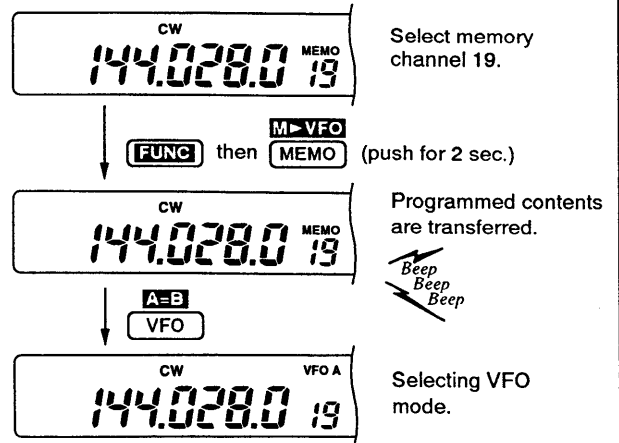

Memory clearing

Any unnecessary memory channels can be cleared. The cleared memory channels become blank channels.

- ① Push [MEMO] to select memory mode.
- ② Select a memory channel to be cleared with the [▲] or [▼] switch.
- ③ Push [FUNC] then [MW·M·CL] for 2 sec. to clear the contents.
 - The programmed frequency and operating mode disappear.
- ④ To clear other memory channels, repeat steps ② and ③.

NOTE: Scan edge channels P1 and P2 cannot be cleared.

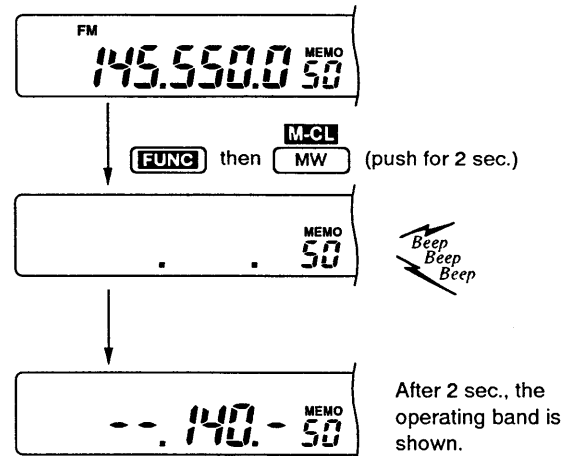

Scan edge channels

Scan edge channels, P1 and P2, are located between the memory channel 80 and channel 1. When operating a programmed scan, the scan operates between these programmed frequencies.

Programming can be performed in the same manner as other memory channels.

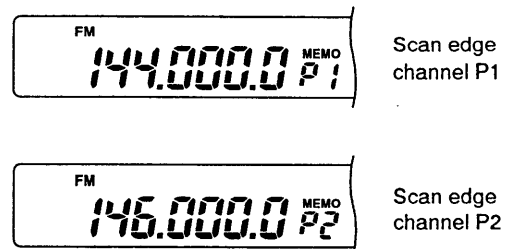

■ Call up a call channel

The call channel is a one-touch accessible channel for recalling your most-often-used frequency. The transceiver has one call channel for each band (a total of 2 channels).

• Calling up

- ① Select the desired band with the [M/S] or [SUB] switch.
- ② Push [CALL] to select the call channel.
- ③ To return to the previous display, push [VFO] or [MEMO].

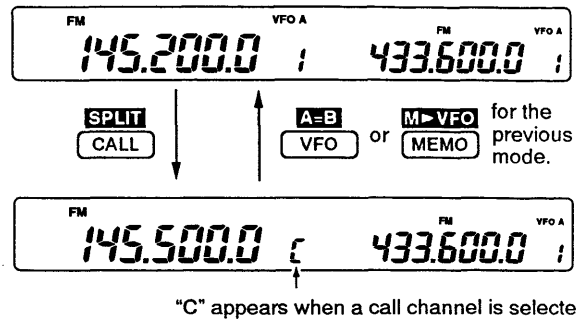

■ Call channel programming

The following contents can be programmed into the call channel in the same way as a memory channel.

- Operating frequency
- Operating mode
- Duplex direction and its offset frequency
- Tone encoder or optional tone squelch and its tone frequency.

• Programming

- ① Select the desired band with the [M/S] or [SUB] switch.
- ② Push [CALL] to call up the call channel.
- ③ While pushing [CALL], rotate the tuning dial to set the desired frequency to be programmed into the call channel.
- ④ Select the desired operating mode with the [FM] or [SSB/CW] switch.
 - Set the tone frequency, offset frequency, etc., if desired.
- ⑤ Push [MW] for 2 sec. to program.

[EXAMPLE]: Programming 145.50 MHz/FM into the call channel.

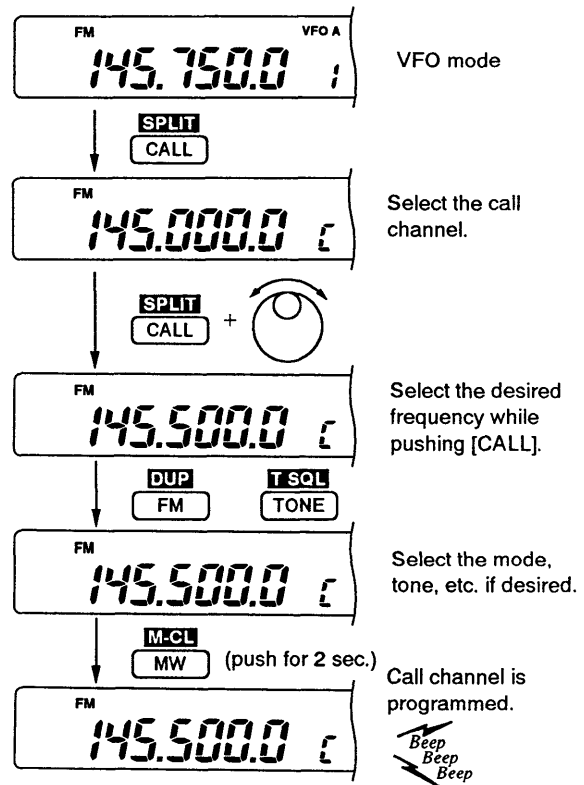

8 SCANS

Scan types

The transceiver has 3 scan types providing tremendous scanning versatility at the touch of a few switches.

Select the scan which matches your operating needs for each band.

The scan function can also be used in the sub band while operating in the main band.

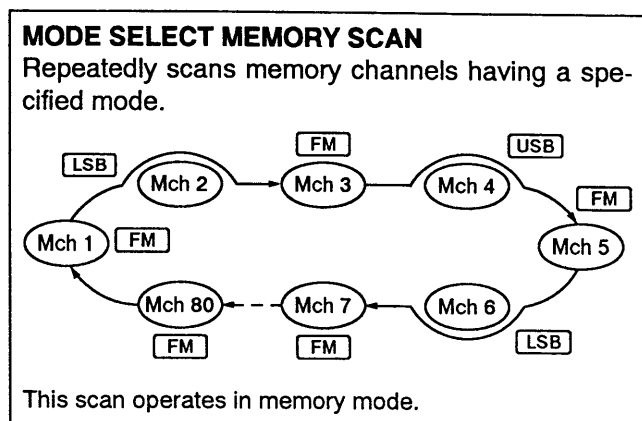
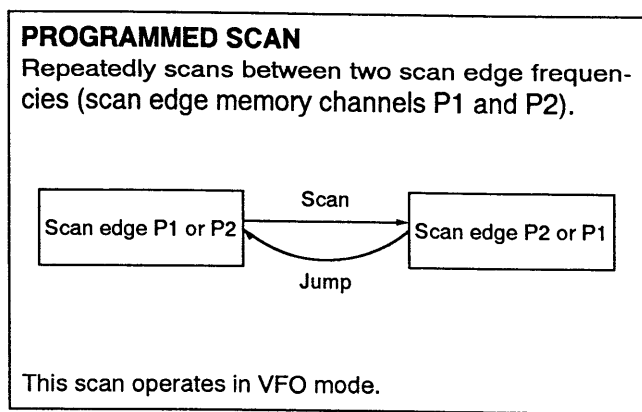
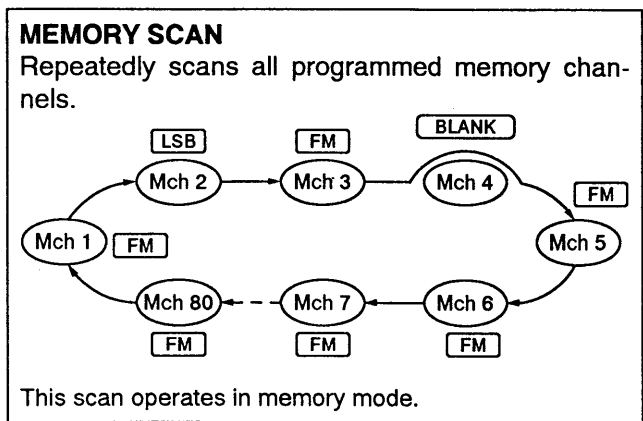

Pre-operation

• Presetting

Program the memory channels before operating a scan as follows:

SCAN TYPE	REQUIRED PRESETTING
PROGRAMMED SCAN	Program scan edge frequencies into scan edge memory channels P1 and P2. (p. 35)
MEMORY SCAN	Program desired scan frequencies into 2 or more memory channels.
MODE SELECT MEMORY SCAN	Program desired scan frequencies with the same operating mode into 2 or more memory channels.

• Scan resume ON/OFF

You can set the scan to resume or cancel when detecting a signal. Scan resume ON/OFF must be set before operating a scan. See p. 49 for ON/OFF setting and scan resume condition details.

• Squelch condition

Before starting a scan, open or close the squelch for the desired operation as described below:

SCAN STARTS WITH	PROGRAMMED SCAN	MEMORY SCANS
SQUELCH OPEN	<ul style="list-style-type: none"> For FM mode, scan pauses (or cancels) on each frequency. For SSB/CW mode, scan continues regardless of the signal condition. 	Scan pauses on each channel when the scan resume is ON; not applicable when OFF.
SQUELCH CLOSED	Scan stops when detecting a signal. If you set scan resume to "ON" in set mode with the [SCAN] switch, the scan pauses for 10 sec. when detecting a signal, then resumes. When a signal disappears while scan is paused, scan resumes 2 sec. later.	

• Scan speed

Scan speed can be selected from 2 levels, high or low, in set mode with the [SCAN] switch. (p. 49)

Programmed scan operation

- ① Push [VFO] to select VFO mode.
- ② Select the desired operating mode.
 - The operating mode can also be changed while scanning.
- ③ Set the desired band's [SQL] open or closed.
 - For FM mode, squelch must be closed.
 - See page at left for scan condition.
- ④ Push [SCAN] to start the scan; push [FUNC] then [SCAN SUB] to start the sub band scan.
 - "SCAN" appears while scanning.
- ⑤ When the scan detects a signal, the scan stops, pauses or ignores it depending on the resume setting and the squelch condition.
 - During scan, the [kHz/MHz] switch can be used.
- ⑥ To cancel the scan, push [SCAN].

NOTE: If the same frequencies are programmed into the scan edge memory channels P1 and P2, programmed scan does not start.

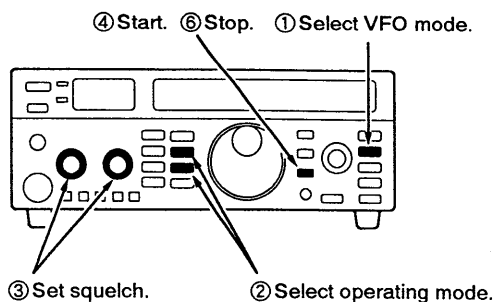

[DISPLAY EXAMPLE DURING A SCAN]

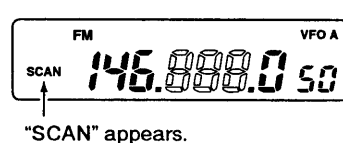

Memory scan operation

- ① Push [MEMO] to select memory mode.
- ② Rotate the desired band's [SQL] to close the squelch.
- ③ Push [SCAN] to start the scan; push [FUNC] then [SCAN SUB] to start the sub band scan.
 - "SCAN" appears.
- ④ When the scan detects a signal, the scan stops or pauses depending on the scan resume setting.
- ⑤ To cancel the scan, push [SCAN].

NOTE: 2 or more memory channels must be programmed for memory scan to start.

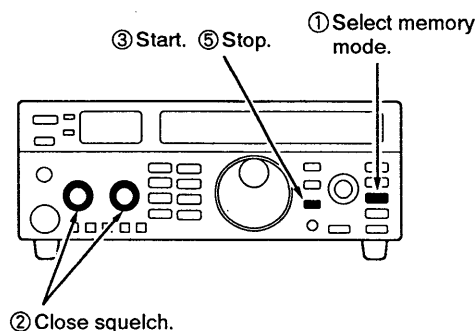

Mode select memory scan operation

- ① Push [MEMO] to select memory mode.
- ② Select the desired mode (USB, LSB, CW or FM).
- ③ Rotate the desired band's [SQL] to close the squelch.
- ④ Push [LOCK] for 2 sec. as a pre-operation for the mode select memory scan.
- ⑤ Push [SCAN] to start the scan; push [FUNC] then [SCAN SUB] to start the sub band scan.
 - While scanning, the "select mode" may be changed by pushing a mode switch, [FM] or [SSB/CW].
- ⑥ When the scan detects a signal, the scan stops or pauses depending on the scan resume setting.
- ⑦ To cancel the scan, push [SCAN].

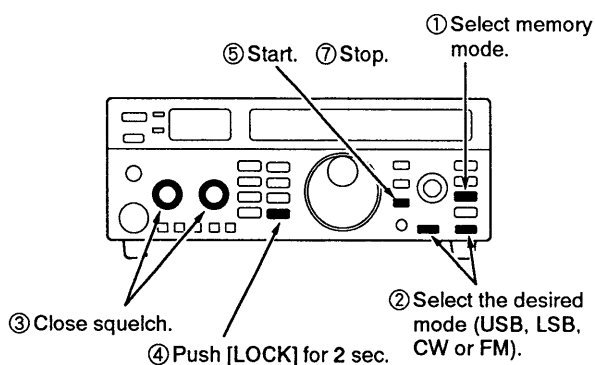

NOTE: 2 or more memory channels must be programmed with the same operating mode for select memory scan to start.

9 SATELLITE OPERATION

Satellite communications outline

Both satellite mode B (435 MHz uplink, 145 MHz downlink) and mode J (145 MHz uplink, 435 MHz downlink) can be operated from the IC-821H.

Satellite communications is possible only when a satellite is in view and its transponder is activated.

Mode B operating diagram

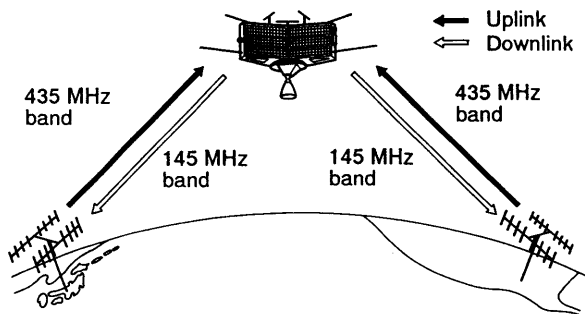

[EXAMPLE]: AMSAT OSCAR 13 (AO-13), Mode B

- Uplink frequency : 435.423–435.573 MHz
- Downlink frequency : 145.975–145.825 MHz
- Tracking direction : Reverse
- General beacon frequency : 145.812 MHz
- Engineering beacon frequency : 145.985 MHz

Panel description while in satellite mode

[CHECK]
Monitors an uplink frequency.

[RIT·M]
After pushing this switch, the tuning dial changes the downlink frequency (main band) only.

[CALL·RIT]
Activates RIT function while in satellite mode for downlink frequency (main band).

[VFO]
Selects satellite VFO mode.

[MEMO]
Selects satellite memory mode.
Transfers the memory contents to the satellite VFO when pushing [FUNC] then this switch for 2 sec.

[SCAN·S]
After pushing this switch, the tuning dial changes the uplink frequency (sub band) only.

[MW]
Programs both uplink and downlink frequencies to the selected satellite memory channels when pushed for 2 sec.

One of these appears to indicate a tracking direction of normal or reverse.



Downlink frequency
(Receive frequency)

Uplink frequency
(transmit frequency)

One of these appears to indicate satellite VFO or satellite memory mode.

Satellite memory channel number

Satellite notes

- NEVER** set the output power too high. Too much power will shorten the satellite's life. Set your transmit power so that your downlink signal level is lower than the beacon's signal level.
- Confirm a satellite's operating mode in advance through documentation (magazines, etc.) or via appropriate satellite tracking software. In the wrong mode, you cannot use the satellite even if you receive its beacon signal.
- Preamplifiers may be necessary to receive satellite signals. Optional AG-25 and AG-35 are available to connect to the IC-821H. (p. 56)
- When you use a reverse tracking satellite in SSB mode, use LSB for the uplink frequency and USB for the downlink frequency.
 - When using a normal tracking satellite in SSB mode, use USB for both the uplink and downlink frequencies.

Operation

- Decide on a usable satellite.
- Confirm the approximate location of the satellite and operating mode (e.g. "B," "J," etc.) through documentation (magazines, etc.) or via appropriate satellite tracking software.
- Set the antenna direction for the desired satellite.
- Select satellite mode on the transceiver.
 - Push [FUNC] then [▼•REV] or [▲•NOR] to select reverse tracking or normal tracking, respectively. (Most satellites can be used with reverse tracking.)
 - When [▼•REV] or [▲•NOR] is pushed for 2 sec. in this step, the displayed frequencies and modes can be used in the satellite VFO.

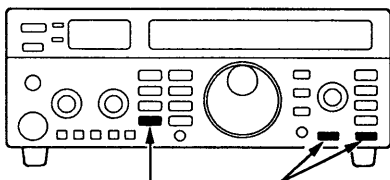

[FUNC] then [REV] or [NOR]

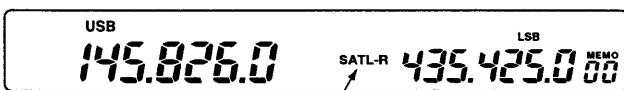

Appears when reverse tracking is selected.

- Select a mode on the transceiver.

Satellite	Downlink (main band)	Uplink (sub band)
Reverse tracking type	USB (or CW)	LSB (or CW)
Normal tracking type	USB (or CW)	USB (or CW)

Another operating mode may be required for digital mode operation.

- Set the downlink frequency (main band) to the beacon frequency.
 - Refer to a ham magazine or book for detailed information.
 - Adjust the antenna direction so that the S-meter swings to its strongest level.
 - The S-meter level should be noted for transmit power selection during a loop test.

- Perform a loop test.
 - Set the downlink frequency (main band) to a vacant frequency within the satellite's coverage.
 - Push [SCAN•S] then, set the uplink frequency (sub band) while transmitting a single tone such as a whistle to find your downlink signal and monitor your own signal correctly. Push [SCAN•S] after setting.

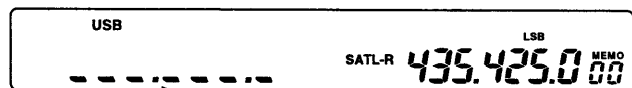

The main band frequency disappears after pushing [SCAN•S].

NOTE: To avoid excessive power, set the output power so that the downlink signal strength is lower than the beacon's strength.

- Set the desired frequency to begin your satellite communications.
 - Both the downlink and uplink frequencies are changed simultaneously.
- When your downlink audio drifts (Doppler effect), push [SCAN•S] then rotate the tuning dial to adjust the uplink frequency (sub band) only. Push [SCAN•S] again after setting.
 - When a particular station's audio is off frequency, use the RIT function (push [CALL•RIT]).
- To exit satellite operation, repeat step ④.
 - Push [FUNC] then [▼•REV] or [▲•NOR].
 - The main and sub band frequencies can be transferred when pushing [▼•REV] or [▲•NOR] for 2 sec. on this step.

CONVENIENT: As the transceiver has 10 satellite memory channels, once set, desired satellites frequencies can be recalled instantly.

NOTE: As the downlink (main band) signal is applied to the sub band unit in circuitry in satellite mode, an optional FL-133 CW NARROW FILTER is necessary to operate CW-N mode.

Satellite VFO and satellite memory

The transceiver has 1 satellite VFO and 10 satellite memory channels to memorize both uplink and downlink frequencies.

Memory programming and memory transferring can be performed in the same manner as normal memory mode operation.

SATELLITE VFO MODE

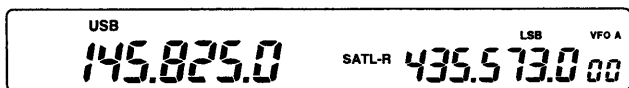

Satellite VFO mode records set frequencies and modes each time they change. Use satellite VFO mode for finding satellites easily.

SATELLITE MEMORY MODE

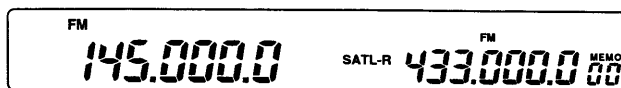

Satellite memory mode keeps programmed frequencies and modes until they are overwritten. These memory channels are convenient for programming data for individual satellites.

Satellite mode selection

When satellite mode is selected, a satellite memory channel or satellite VFO appears. When you have set frequencies in normal VFO mode, the set frequencies can be transferred to the satellite VFO.

To select satellite VFO along with set frequencies:

- Push [FUNC], then push [▼•REV] or [▲•NOR] for 2 sec.

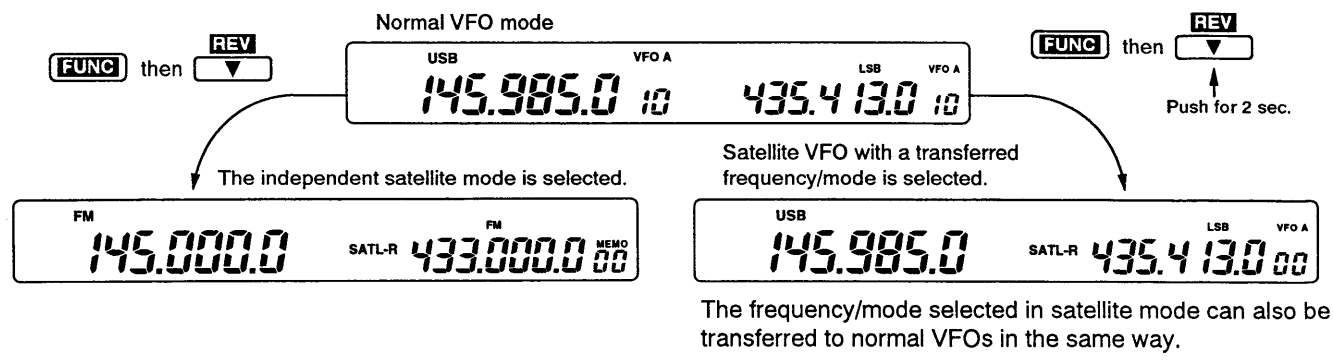

Satellite memory programming

- ① Select satellite mode.
- Push [FUNC] then push (or push for 2 sec.) [▼•REV] or [▲•NOR].
- ② Push [▼] or [▲] to select the desired satellite memory channel.
- ③ Push [VFO] to select satellite VFO mode if desired.
- Memory programming can be performed in both satellite VFO and satellite memory modes.
- ④ Select the desired frequencies and modes for uplink and downlink.
- ⑤ Push [MW] for 2 sec. to program the set contents to the satellite memory channel.

[EXAMPLE]: Programming 435.54 (LSB) / 145.88 (USB) into satellite memory channel 1.

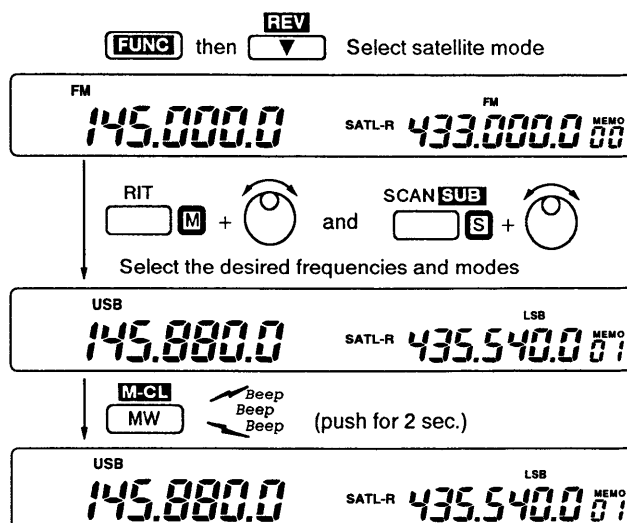

CI-V connection example

The transceiver can be connected through an optional CT-17 CI-V LEVEL CONVERTER to a personal computer equipped with an RS-232C port. The Icom Communication Interface-V (CI-V) controls the following functions of the transceiver.

Up to four Icom CI-V transceivers or receivers can be connected to a personal computer equipped with an RS-232C port. See p. 44 for setting the CI-V condition using set mode with the [CHECK] switch.

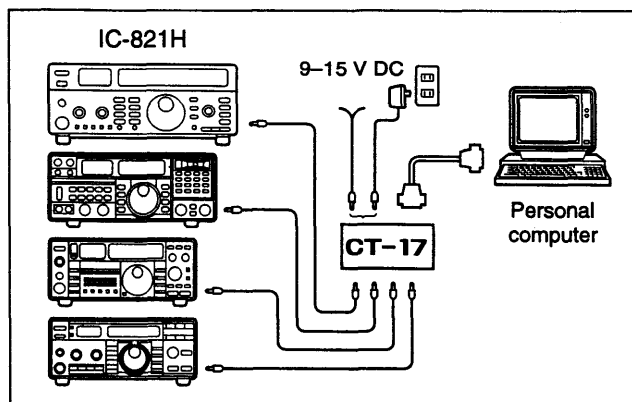

CI-V data format

The CI-V system can be operated using the following data formats. Data formats differ according to command numbers. A data area is added for some commands.

CONTROLLER TO IC-821H

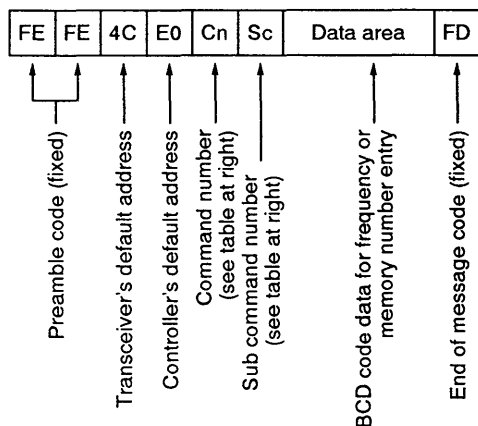

OK MESSAGE TO CONTROLLER

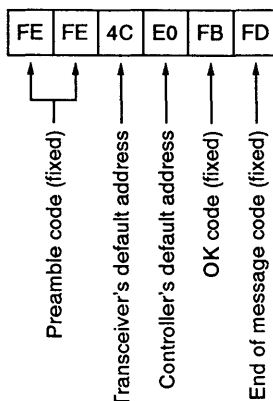

IC-821H TO CONTROLLER

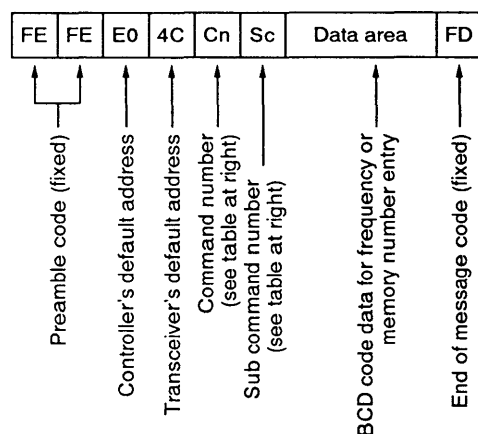

NG MESSAGE TO CONTROLLER

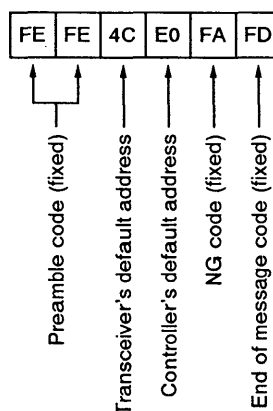

COMMAND TABLE

Description	Cn	Sc	
Frequency control	05	-	
Operating mode control	06	LSB	00
		USB	01
		CW normal	0301
		CW narrow	0302
		FM	05
VFO mode	07	-	
VFO A		00	
VFO B		01	
A=B		A0	
MAIN/SUB		B0	
Main band access		D0	
Sub band access		D1	
Memory mode	08	-	
Memory selection		mc*	
Memory write	09	-	
Memory ► VFO	0A	-	
Memory clear	0B	-	
Offset read	0C	-	
Offset write	0D	-	
Scan stop	0E	00	
Start scan		01	
Split OFF	0F	00	
Split ON		01	
Simplex selection		10	
Duplex - selection		11	
Duplex + selection		12	

* Memory channel number
P1=0100, P2=0101, CALL=0102

11 SET MODE

■ Set mode description

Set mode is used for programming infrequently changed values or conditions of functions. This transceiver has set mode groups with the following switches which are related by contents or values.

- The [M/S], [CHECK], [TONE], [FUNC], [SUB], [FM], [SSB/CW], [RIT], [kHz/MHz], [SCAN], [ATT] and [PREAMP] switches have set mode content(s).

• Set mode operation

- ① Push [SPCH•SET] for 2 sec. to enter set mode.

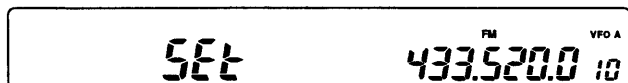

- ② Push the desired key one or more times to select a set mode display.

- Push the [M/S], [CHECK], [TONE], [FUNC], [SUB], [FM], [SSB/CW], [RIT], [kHz/MHz], [SCAN], [ATT] or [PREAMP] switch.

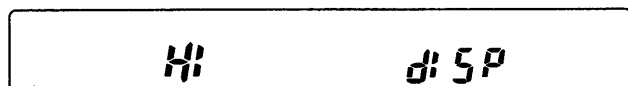

- ③ Rotate the tuning dial to set the values or conditions for the selected item.

▨ Push [MW] to call up its default values or conditions for your convenience.



- ④ To select other set mode display in the switch group, push the switch one or more times.

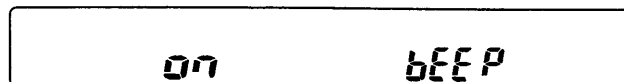

- ⑤ Push [SPCH] to exit the set mode.

- ⑥ Repeat steps ① – ⑤ to set other items.

◇ Set mode with [M/S]

(1) 9600 bps data mode "9600"

The transceiver accepts data speeds of up to 9600 bps via the ACC socket. Set the data speed to 9600 or 1200 bps.

- When using the [MIC] connector, the transceiver accepts up to 1200 bps regardless of this setting.

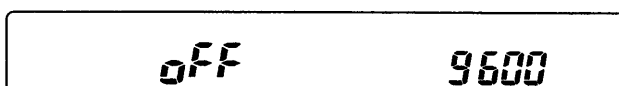

9600 bps data mode OFF (default)



9600 bps data mode ON

(2) ACC socket (AF/squelch) "ACC P5.6"

The ACC socket pins 1, 5 and 6 outputs main band AF, direct detector or squelch output. This can be changed to sub band's outputs, if desired.

- See p. 9 for the ACC socket details.

- Pin 1 outputs main or sub band AF signal when 9600 bps data mode is selected as above.



Main band signals are output. (default)

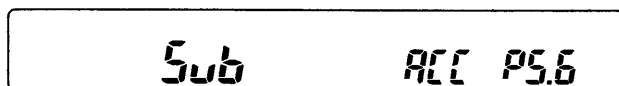

Sub band signals are output.

(3) ACC socket (ALC or mic up/down) "ACC P8"

The ACC socket pin 8 inputs and outputs the ALC voltage. This can be changed to input the microphone up/down signal, if desired.

- See p. 9 for the ACC socket details.



ALC voltage input/output (default)

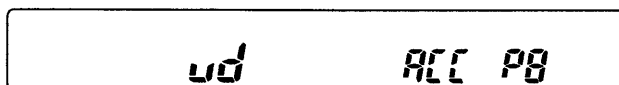

Microphone up/down signal input

(4) ACC socket (AF input level) "ACC t-AF"

The ACC socket pin 4 inputs an AF modulation signal. The input level can be selected to 100 mV or 2 mV.

- See p. 9 for the ACC socket details.
- The input level is fixed to 1.0 Vp-p (0.35 V rms) when 9600 bps data mode is selected in item (1).

Hi ACC t-AF

Modulator input level is high (100 mV). (default)

Lo ACC t-AF

Modulator input level is low (2 mV).

(5) Headphone jack "SEPA"

The headphones' audio output can be set for a mix of main and sub band audio or for separated main and sub band channels when using stereo headphones.

off SEPA

Main and sub band audio is mixed. (default)

on SEPA

Main and sub band audio is separated for each channel.

◇ **Set mode with [CHECK]**

(1) CI-V address "CI-Addr"

The IC-821H has the address of 4CH (76) as its default value.

If you want to designate a different address for your IC-821H, select the desired address in the range from 1H (1) to 7FH (127).

- Figures marked with an H are hexadecimals and bracketed figures () are decimals.

4CH CI-Addr

Address of 4CH (default)

7FH CI-Addr

Address of 7FH

(2) CI-V baud rate "CI-bAud"

Baud rate is the data transfer rate. The standard baud rate for the Icom CI-V is 1200 bps.

When "Auto" is selected, the baud rate is automatically set with the connected controller or remote controller.

If you want to change the baud rate, rotate the tuning dial to select the desired baud rate from 300 bps, 1200 bps, 4800 bps, 9600 bps or 19200 bps.

Auto CI-bAud

Automatic baud rate (default)

1200 CI-bAud

1200 bps (CI-V standard)

19200 CI-bAud

19200 bps

(3) CI-V transceive "CI-trn"

Transceive operation is possible with the IC-821H connected to other Icom transceivers or receivers.

When "on" is selected, changing the operating frequency, operating mode, etc. on the IC-821H automatically changes those of connected transceivers (or receivers) and vice versa.

on CI-trn

Transceive ON (default)

off CI-trn

Transceive OFF

11 SET MODE

◇ Set mode with [CHECK] (continued)

(4) Squelch threshold level "Sql nob"

The SSB threshold point can be set to the 9 or 12 o'clock position.

When setting to the 12 o'clock position, the signal strength to open the squelch is nearly equal for FM and SSB/CW modes.

9 59L nob

9 o'clock position (default)

12 59L nob

12 o'clock position

◇ Set mode with [TONE]

(1) Subaudible tone frequency "T" (U.S.A. and Australia versions only)

To set the subaudible tone frequency, select FM mode with subaudible tone ON in advance.

- There are 50 tones available from 67.0 Hz to 254.1 Hz.
(see the table on p. 31)

T 88.5 433.520.0 10 FM VFO A

88.5 Hz subaudible tone frequency (default)

(2) Optional tone squelch frequency "T-SQL" (UT-84 is required)

To set the tone squelch frequency, select FM mode with tone squelch ON in advance.

- There are 50 tones available from 67.0 Hz to 254.1 Hz.
(see the table on p. 24)

T-SQL 88.5 433.520.0 10 FM VFO A

88.5 Hz tone squelch frequency (default)

◇ Set mode with [FUNC]

(1) Display intensity "dISP"

The display backlight can be set to one of 2 intensity levels. Choose a level suitable for your operating environment or personal preference.

Hi dISP

High intensity (default)

Lo dISP

Low intensity

(2) Confirmation beep "bEEP"

A beep sounds each time a switch is pushed for confirmation. This confirmation beep can be turned OFF for silent operation.

Beep tone volume can be adjusted. (p. 53)

on bEEP

Confirmation beep ON (default)

(3) Time out-timer "tot"

To prevent extended continuous transmission with the crossband full duplex operation, etc., the transceiver has a time-out timer. This timer selects receive 3, 5, 10, 20 or 30 min. after transmission starts. This timer can be cancelled.

When the time-out time elapses, the transceiver stops transmitting with beep tones.

off tot

Time-out timer OFF (default)

30 tot

30 min. time-out timer is selected.

(4) PTT lock "Ptt-L"

The PTT lock function locks the PTT switch and [TRANSMIT] electronically to prevent accidental transmission.

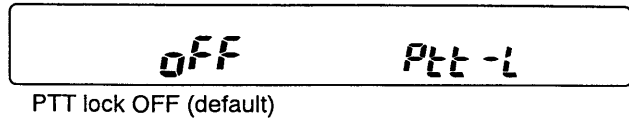

(5) Fine tuning indication "Fr-dISP"

While rotating the tuning dial, the memory channel readout shows 10 Hz and 1 Hz digits instead of the memory channel number. This indication can be turned OFF if desired.

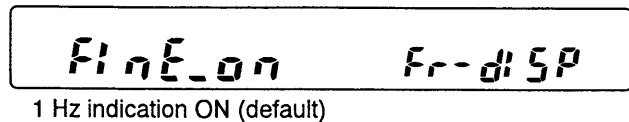

When turning the 10/1 Hz indication OFF, the tuning resolution remains at the specified value and can be checked by pushing [M/S].

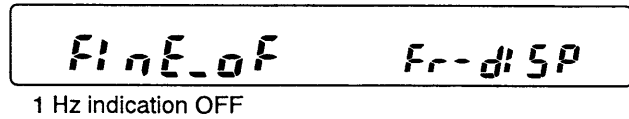

(6) Optional voice synthesizer language

"SPC-LAN" (Effective when UT-102 is installed.)

The optional UT-102 VOICE SYNTHESIZER UNIT announces the selected frequency, mode and selected VFO or memory channel when [SPCH] is pushed momentarily.

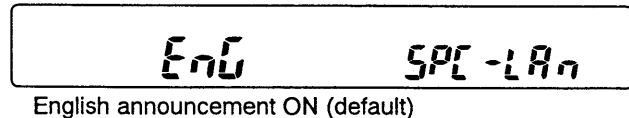

You can select between English and Japanese as the language or cancel the announcement without removing the UT-102 for silent operation.

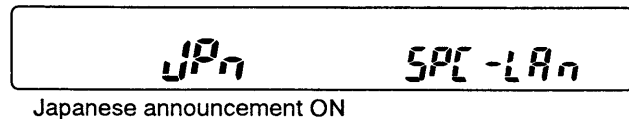
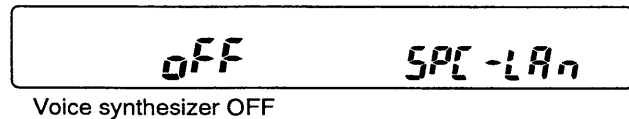

(7) Announcement speed "SPC-SPd"

(Effective when UT-102 is installed.)

You can select between faster ("HI") or slower ("Lo") announcement when an optional UT-102 VOICE SYNTHESIZER UNIT is installed.

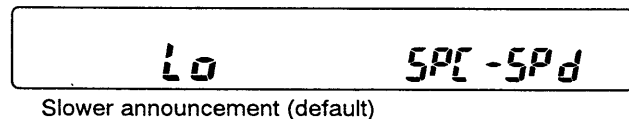

◇ **Set mode with [SUB]**

(1) Sub band S-meter "Sub-S"

When receiving a signal on the sub band, the S-meter in the function display shows the received signal strength. If you do not desire S-meter indication on the sub band, it can be deactivated.

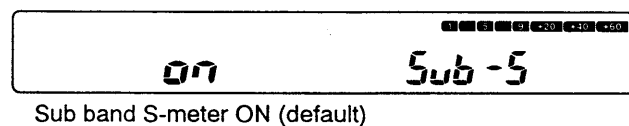

(2) Sub band audio during transmit

"SUB Audio"

When transmitting on the main band, the sub band's sensitivity is decreased. At this time, sub band audio can be muted automatically.

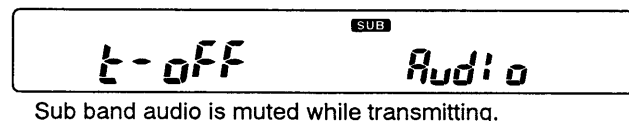
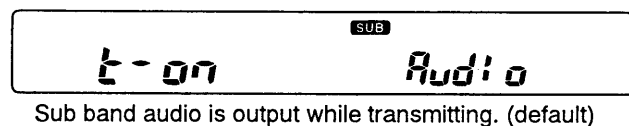

11 SET MODE

◇ Set mode with [FM]

(1) One-touch repeater "o_touch"

(U.S.A. and Australia version only)

The repeater settings (DUP+ or DUP- and tone encoder ON) can be activated by simply pushing [FM] in FM mode. See p. 32 for details.

DUP-- o_touch 433.520.0^{FM} 10^{VFO A}

"DUP -" is selected to the one-touch repeater function. (default)

DUP+ o_touch 433.520.0^{FM} 10^{VFO A}

"DUP +" is selected to the one-touch repeater function.

(2) Offset frequency "DUP+" or "DUP-"

To set the offset frequency, select FM mode with duplex setting (DUP+ or DUP-) in advance. See p. 31 for details.

- Selectable step increment is the same as the preset tuning step in FM mode. (p. 18)
- 1 kHz tuning step is selected in SSB/CW mode.
- Use [kHz/MHz] for quick frequency setting.

DUP-- 0.600.0 433.520.0^{FM} 10^{VFO A}

0.6 MHz (600 kHz) offset frequency is selected for the VHF band. (default)

(3) FM center indicator "CEntEr"

When the received signal is off-center in FM mode, the green receive indicator flashes. When you desire no such indication, set this item to "oFF" to deactivate the center indicator function.

on CEntEr^{FM}

FM center indicator ON (default)

off CEntEr^{FM}

FM center indicator OFF

(4) Automatic repeater setting "Aut or Pt"

(U.S.A. and Australia* versions only)

Repeater frequency coverage is usually fixed depending on your area of operation. When selecting a frequency within the frequency coverage, the transceiver can set to select duplex automatically if desired. Also, the subaudible tone encoder can be turned ON together with the duplex setting.

* Pre-programming of a repeater range is necessary for the Australia version. (p. 32)

off Aut or Pt

Automatic repeater selection OFF (default)

1 Aut or Pt

Duplex as the automatic selection

2 Aut or Pt

Duplex and tone encoder as the automatic selection

◇ Set mode with [SSB/CW]

(1) CW break-in "br-In"

CW break-in function toggles transmit and receive with CW keying. When "oFF" is selected, push [TRANSMIT] IN to transmit manually before keying.

Adjust the [DELAY] control on the rear panel for switching times from transmit to receive when break-in is set to "ON."

on br-In^{CW}

Semi break-in is turned ON. (default)

off br-In^{CW}

Semi break-in is turned OFF.

(2) CW side tone level control "SIDE-t"

The [CW SIDE TONE] control on the rear panel controls the CW side tone level. This setting determines whether the output level is controlled by the [CW SIDE TONE] control only or is related to the [AF] control.

nor *SIDE-t*

Side tone is controlled by [CW SIDE TONE] only. (default)

USER *SIDE-t*

Side tone is controlled by [CW SIDE TONE] and [AF].

(3) CW keyer "PADDLE"

The internal electronic keyer can be set to normal polarity or reverse polarity; or turned OFF to use a straight key or external electronic keyer. (p. 27)

The up/down keys of the microphone can be substituted for a paddle. When "ud" is selected, they do not function as up/down keys in all mode.

r *PADDLE*

Reverse keyer polarity

OFF *PADDLE*

Electronic keyer OFF (straight key)

n *PADDLE*

Normal keyer polarity (default)

ud *PADDLE*

Substitute paddle function ON (microphone [UP]/[DN])

(4) Keying weight "rAtio"

The keying weight, the ratio of dot : space : dash, can be set from 1 : 1 : 2.8 to 1 : 1 : 4.5 for your preference. See p. 28 for a detailed description.

3.0 *rAtio*

1:1:3 keying weight (default)

◇ **Set mode with [RIT]**

(1) Sub tuning dial function for [RIT]
"rit nob"

The sub tuning dial function tunes a frequency without the tuning dial. This function can be assigned to the [RIT] or [SHIFT] control to suit your operating preference. See p. 20 for details.

rit *rit nob*

[RIT] functions as [RIT] even when the sub tuning dial function is activated. (default)

(2) Sub tuning dial function for [SHIFT]
"SFt nob"

The sub tuning dial function tunes a frequency without the tuning dial. This function can be assigned to the [RIT] or [SHIFT] control to suit your operating preference. See p. 20 for details.

SFt *SFt nob*

[SHIFT] functions as [SHIFT] even when the sub tuning dial function is activated. (default)

◇ **Set mode with [kHz/MHz]**

(1) Spot function "Spot"

A beep sounds to alert you when tuning across the spot frequency (or memory channel). This beep can be turned OFF if desired.

on *SPot*

Spot function ON (default)

11 SET MODE

◇ Set mode with [SCAN]

(1) Scan resume "SC-rES"

When receiving a signal during a scan, scan pauses 10 sec., then restarts even when continuing to receive the signal. When you want to cancel a scan after receiving a signal, set this item to "oFF."

on SC-rES
Scan resumes (default)

oFF SC-rES
Scan is canceled.

(2) Scan speed "SC-SPd"

The transceiver has 2 speeds for scanning, high and low.

Hi SC-SPd
High speed (default)

Lo SC-SPd
Low speed

◇ Set mode with [ATT]

(1) Attenuator activation "Att"

When [ATT] is pushed, the attenuator circuits in both the 144 and 430 MHz bands activate. When only 1 band requires the attenuator, such as for an interfering electrical field in your area, the [ATT] switch's function can be specified for the desired band only.

140.400 Att
Attenuator activates for both 144 and 430 MHz bands. (default)

140. Att
Attenuator activates for 144 MHz band only.

.400 Att
Attenuator activates for 430 MHz band only.

◇ Set mode with [PREAMP]

(1) External preamplifier selection "PrE"

When optional external preamplifiers (mast-mount type), AG-25 (144 MHz) and AG-35 (430 MHz) are connected to the antennas, set this item according to the connected preamplifiers.

This setting applies DC voltage to antenna connectors while receiving, therefore, the selection must be OFF when no preamplifier is connected.

140.400 PrE
Preamps connected to both bands (default)

.400 PrE
Preamp connected to 430 MHz band only

140. PrE
Preamp connected to 144 MHz band only

oFF PrE
No preamp is connected.

Opening the transceiver's case

Follow the case and cover opening procedures shown here when you want to install an optional unit or adjust the internal units, etc.

CAUTION: DISCONNECT the DC power cable from the transceiver before performing any work on the transceiver. Otherwise, the transceiver may be damaged.

- ① Remove 8 screws from the transceiver's top and 4 screws from the sides, then lift up the top cover.
- ② Turn the transceiver upside down.
- ③ Remove 4 screws from the bottom cover, then lift up the bottom cover.
- ④ Now you can see the MAIN unit.

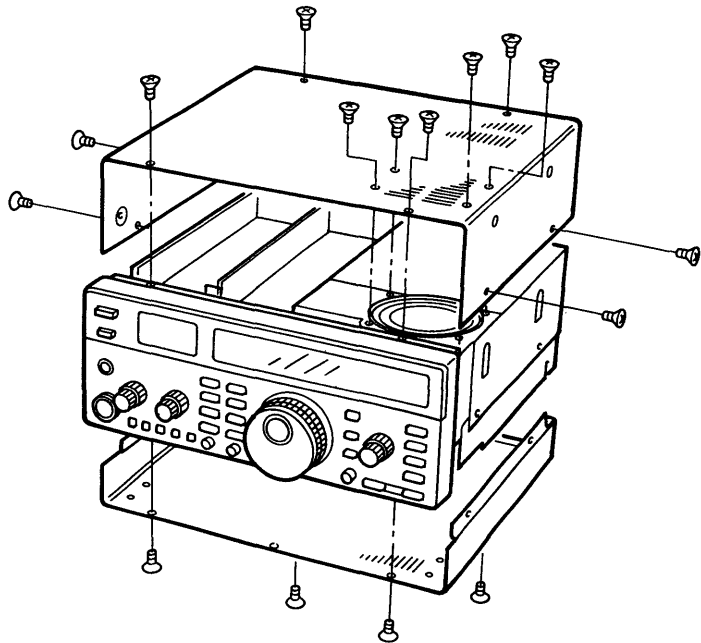

Opening the inside chassis

- ① Remove the top and bottom covers as shown above.
- ② Loosen the gutter screw on each side of the front panel's rear side.
- ③ Remove 1 screw from each side of the front panel's rear side.
- ④ Pull the front panel forward as shown by the arrow at right.
- ⑤ Loosen 1 flat head screw from each side of the MAIN unit chassis.
- ⑥ Remove the 2 silver screws from the rear panel.
- ⑦ Lift up the MAIN unit chassis to see the PLL unit.
- ⑧ Tighten the screws (labelled ⑤) to fix the MAIN unit chassis in a vertical position.

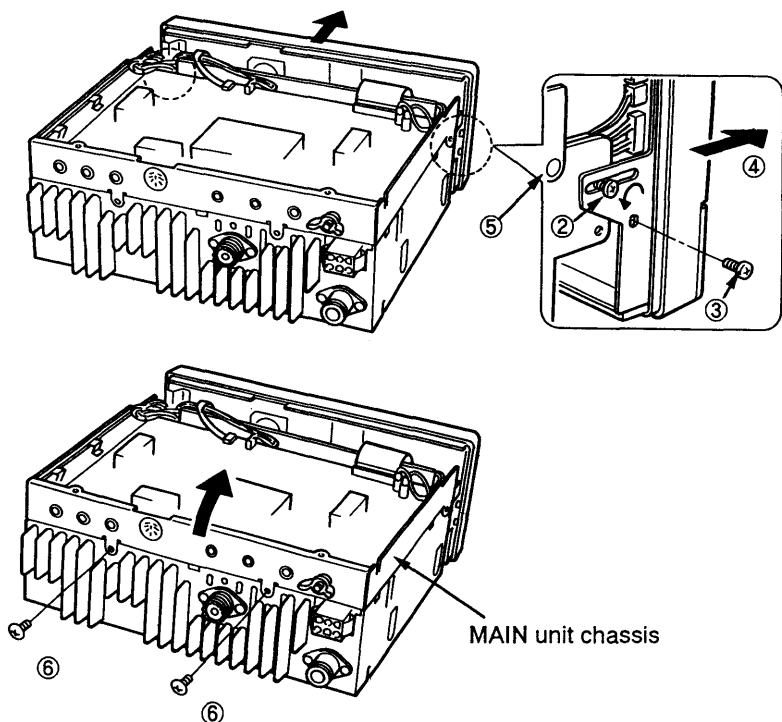

12 OPTION INSTALLATIONS

■ UT-84 TONE SQUELCH UNIT

The UT-84 TONE SQUELCH UNIT allows you to operate the tone squelch and tone scan. The UT-84 can be used for both bands simultaneously.

- ① Remove both the top and bottom covers. (p. 50)
- ② Plug UT-84 to J20 on the MAIN unit as shown at right.
- ③ After installing the unit, replace the top and bottom covers.

Space for UT-84
tone squelch unit

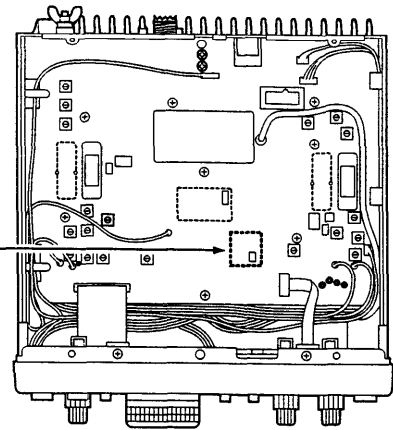

■ FL-132/FL-133 CW NARROW FILTER

The transceiver has a CW-Narrow mode to provide better S/N (signal-to-noise), or to reject nearby interference. To use the CW-Narrow mode, an optional CW narrow filter is necessary.

NOTE: For CW-Narrow mode during satellite operation, the FL-133 (for sub band filter) is necessary since the sub band circuit is used for receiving although the main band display shows receive frequency.

FILTER	Passband width	
	at -6 dB	at -60 dB
Built-in filter	2.3 kHz	4.2 kHz
FL-132/133	500 Hz	1.34 kHz

- ① Remove both the top and bottom covers. (p. 50)
- ② Remove 13 screws from the MAIN unit. (Fig. 1)
- ③ Slide the MAIN unit forward slightly to free the [DELAY] and [CW SIDE TONE] control knobs from the rear panel.
- ④ Lift up the MAIN unit from the rear panel side. (Fig. 2)
- ⑤ Install the FL-132 and/or FL-133 in the proper position.
- ⑥ Cut the filter leads, keeping 2-3 mm (1/8 in) leads from the bottom of the MAIN unit.
- ⑦ Solder the leads.
- ⑧ Replace the MAIN unit.
- ⑨ Fit the wires from the rear of the front panel in the open space between the chassis and MAIN unit. (Fig. 1)
 - Otherwise, the wires will be pinched by the bottom cover and the transceiver may be damaged.
- ⑩ Replace the top and bottom covers.

Fit the wires in the open space
after installation. (⑨)

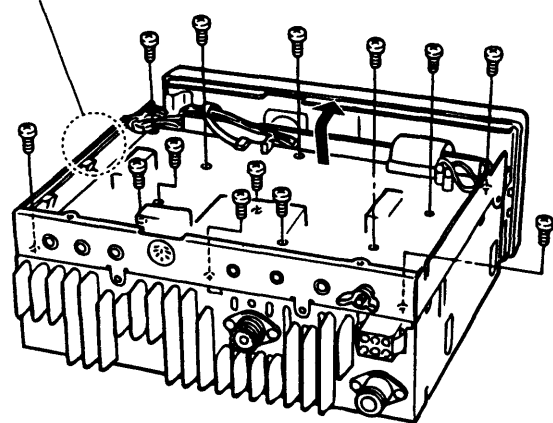

(Fig. 1)

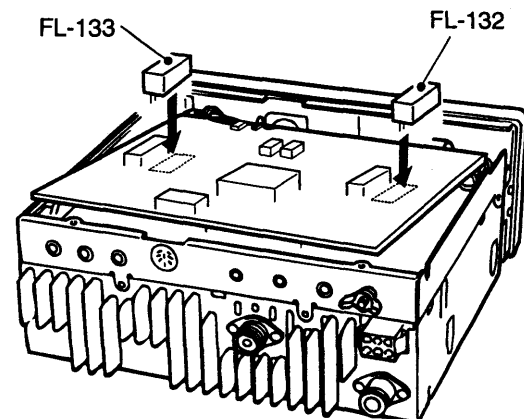

(Fig. 2)

■ UT-102 VOICE SYNTHESIZER UNIT

The UT-102 announces the accessed band's frequency, mode, etc. in a clear, electronically-generated voice, in English (or Japanese).

- ① Remove both the top and bottom covers. (p. 50)
- ② Remove the protective paper attached to the bottom of the UT-102 to expose the adhesive strip.
- ③ Plug UT-102 to J25 on the MAIN unit as shown at right.
- ④ Adjust R469 to set the speech level if desired.
- ⑤ After installing the unit, replace the top and bottom covers.

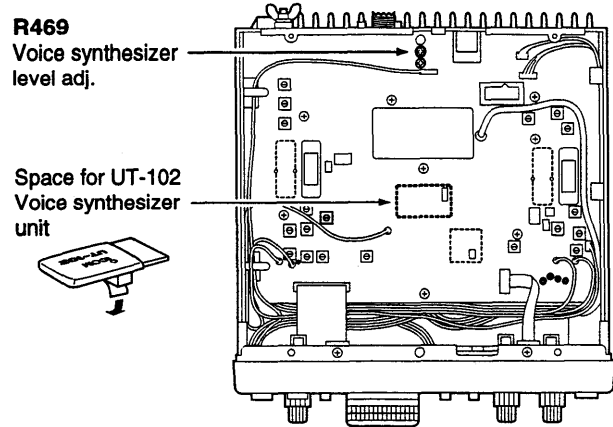

■ CR-293 HIGH STABILITY CRYSTAL UNIT

A temperature-compensating crystal with a stability of ± 3 ppm is built-in to the transceiver. For more demanding operation, such as during transverter use, etc., the CR-293 HIGH-STABILITY CRYSTAL UNIT is available. It has a stability of ± 0.5 ppm.

- ① Remove both the top and bottom covers. (p. 50)
- ② Open the MAIN unit chassis. (p. 50)
- ③ Remove the shield cover from the PLL unit. (Fig. 1)
- ④ Remove 7 screws from the PLL unit, then lift up the PLL unit to expose the bottom side of the unit. (Fig. 2)
- ⑤ Unsolder the 3 points of the built-in crystal's lead on the bottom of the PLL unit and the 1 point of the crystal's case.
 - Use a desoldering braid.
- ⑥ Replace the built-in crystal with the CR-293 and solder the leads of the CR-293.
- ⑦ Replace the PLL unit and the 7 screws.
- ⑧ Replace the PLL unit cover, MAIN unit chassis, and top/bottom covers.

NOTE: The CR-293 is an oven-type crystal unit, and specified frequency stability described above is guaranteed 1 min. after power ON.

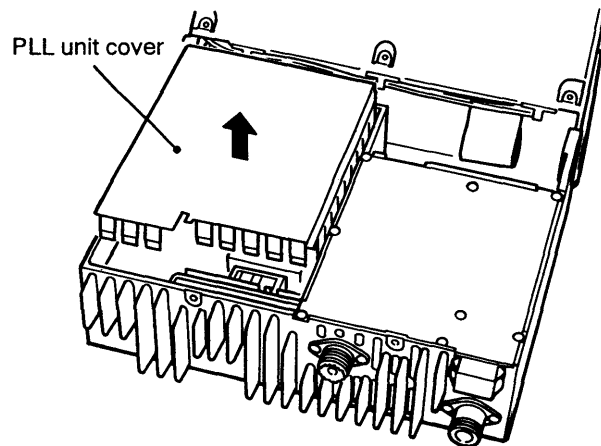

Fig. 1

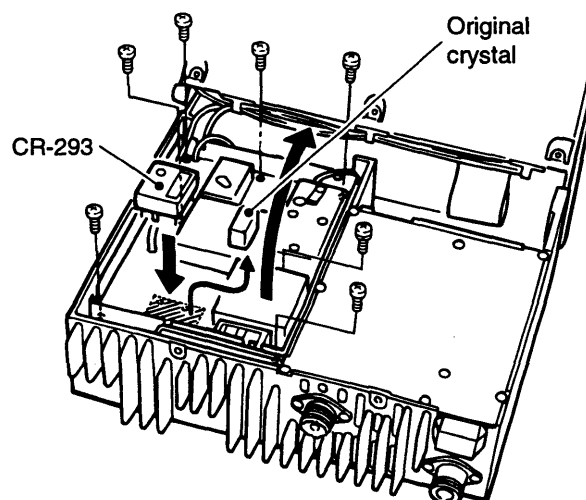
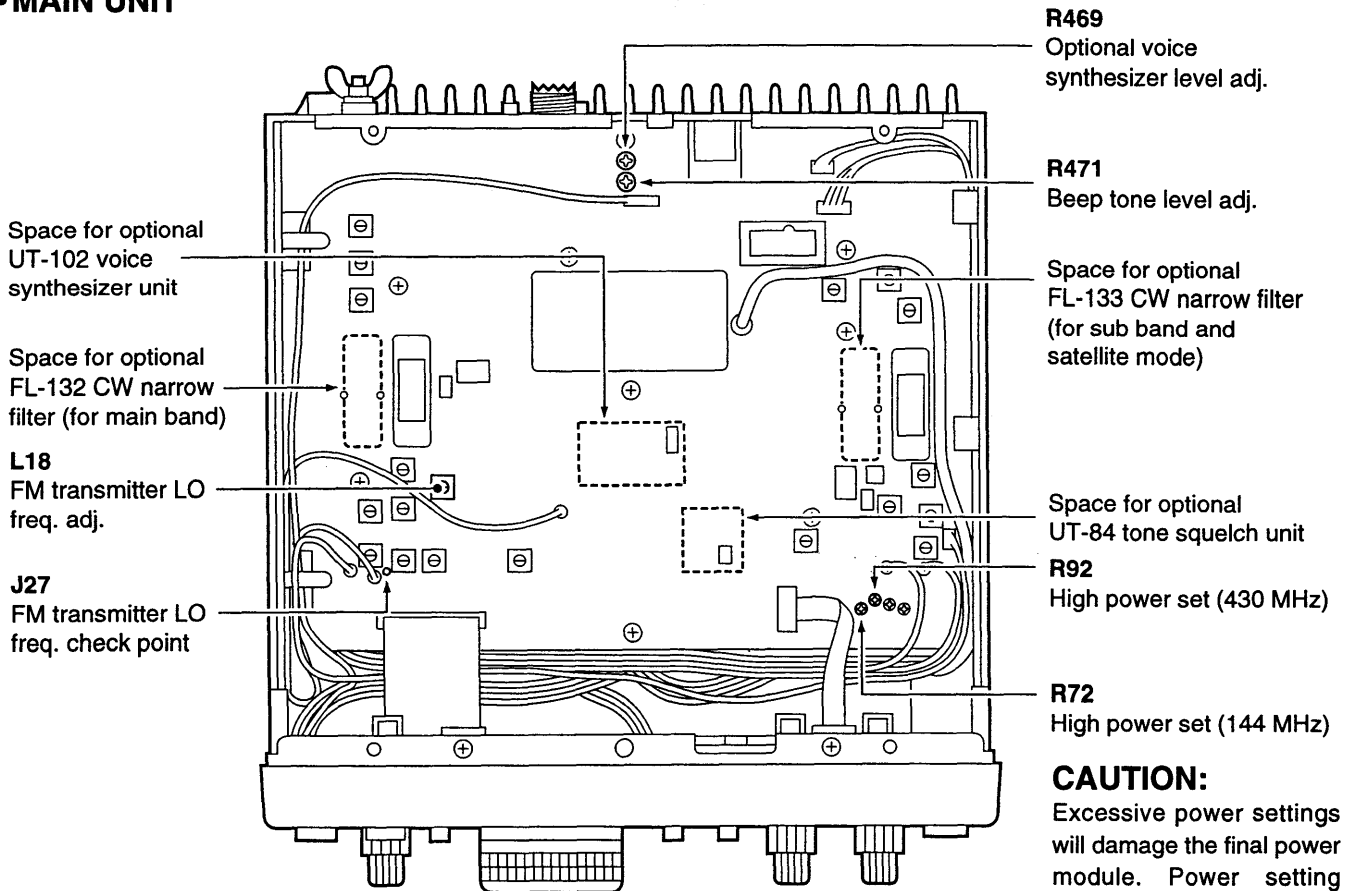

Fig. 2

13 INTERNAL VIEWS

• MAIN UNIT



CAUTION:
Excessive power settings will damage the final power module. Power setting should be done by qualified technicians only.

• RF AND PA UNITS

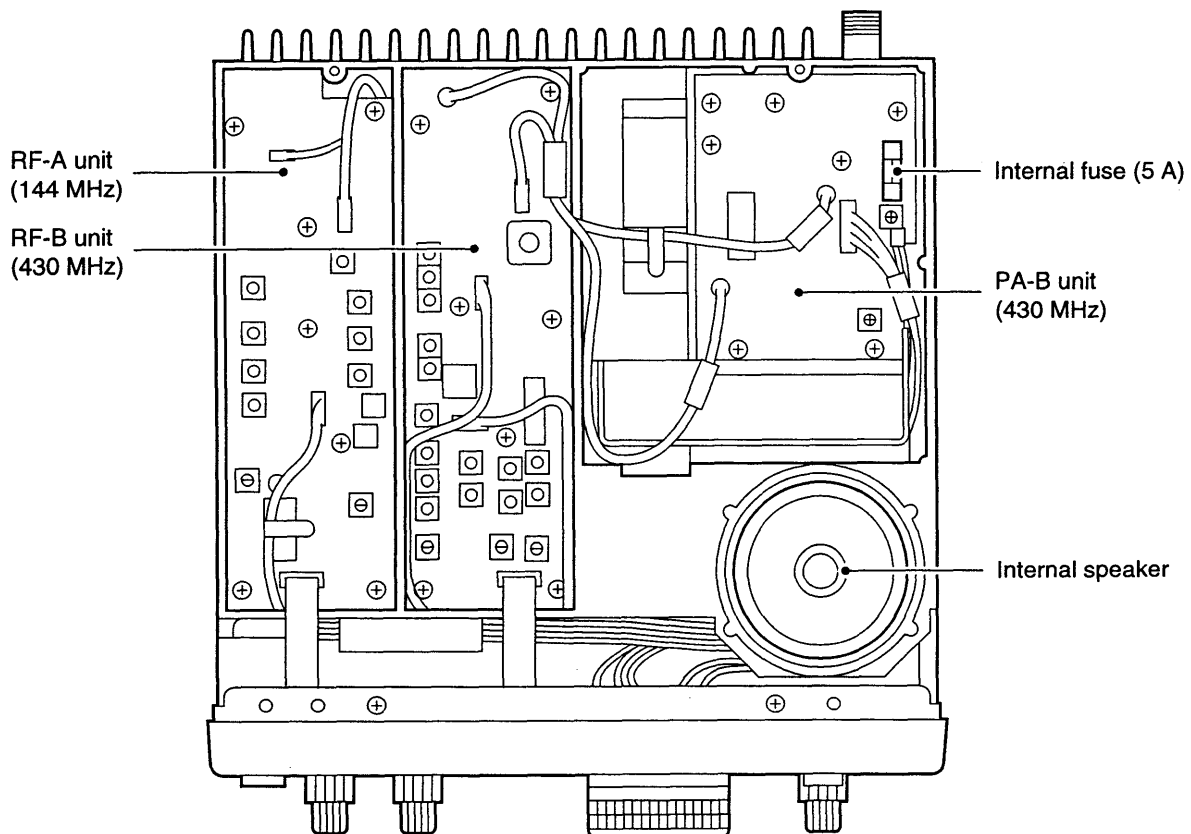

Troubleshooting

	PROBLEM	POSSIBLE CAUSE	SOLUTION	REF.
POWER	Power does not come on when [POWER] is pushed IN.	<ul style="list-style-type: none"> • Fuse is blown. • DC power cable is improperly connected. 	<ul style="list-style-type: none"> • Check for the cause, then replace the fuse with a spare one. (Fuses are installed in two places, in the DC power cable and in the PA-B unit.) • Reconnect the power cable correctly. Also, check the fuse in the DC power cable. 	See below. p. 53 p. 13
	No sound comes from the speaker.	<ul style="list-style-type: none"> • The squelch is closed. • An optional tone squelch is in use. • CW-Narrow mode is selected when an optional CW-Narrow filter is not installed. 	<ul style="list-style-type: none"> • Rotate [SQL] counterclockwise to open the squelch. • Turn OFF the tone squelch or push and hold [CHECK] to monitor all signals. • Select another mode. 	p. 21 pgs. 21, 24 p. 19
RECEIVE	Sensitivity is low.	<ul style="list-style-type: none"> • The attenuator is turned ON. • The VHF antenna is connected to the UHF antenna connector and vice versa. 	<ul style="list-style-type: none"> • Push the [ATT] switch to turn the function OFF. • Check the antennas and antenna connections. 	p. 23 p. 11
	Preamplifier does not function.	<ul style="list-style-type: none"> • An optional preamplifier is not connected. • Preamplifier is set to OFF in set mode. 	<ul style="list-style-type: none"> • Connect an optional AG-25 (144 MHz) or AG-35 (430 MHz) if needed. • Set to ON for the preamplifier connected band. 	pgs. 12, 49 p. 49
TRANSMITTER	Transmitting is not possible.	<ul style="list-style-type: none"> • The [MIC] control is set too far counterclockwise when operating in SSB mode. 	<ul style="list-style-type: none"> • Set the [MIC] control to the center position. 	p. 25
	Output power is low.	<ul style="list-style-type: none"> • The VHF antenna is connected to the UHF antenna connector and vice versa. • The [RF PWR] control is set too far counterclockwise. 	<ul style="list-style-type: none"> • Check the antennas and antenna connections. • Rotate the [RF PWR] control clockwise. 	p. 11 p. 25
DISPLAY	Frequency cannot be set.	<ul style="list-style-type: none"> • The call channel is selected. • The lock function is activated. 	<ul style="list-style-type: none"> • Select VFO or memory mode. • Turn OFF the lock function. 	p. 36 p. 19
	Frequency is automatically changed.	<ul style="list-style-type: none"> • Sub tuning dial function is activated. 	<ul style="list-style-type: none"> • Turn OFF the sub tuning dial function or set the [RIT] or [SHIFT] control to the center. 	p. 20

Fuse replacement

If the fuse blows or the transceiver stops functioning, find the source of the problem if possible, and replace the damaged fuse with a new, rated fuse.

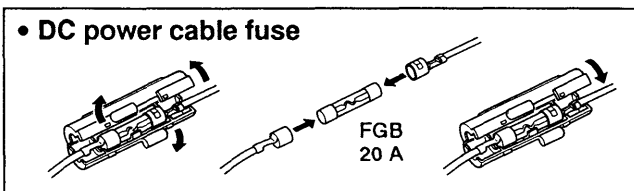

Internal fuse

An internal fuse is installed on the line affecting all circuits except the V/UHF PA circuits. The fuse is located in the PA-B unit. See the left page for location.

- Internal fuse: FGMB 125 V / 5 A

CPU resetting

If the function display shows erroneous information when first applying power, the CPU may require resetting. CPU resetting clears all memory information.

• CPU RESET PROCEDURE:

- While pushing [MW], turn power ON.

Demonstration mode

A demonstration function is available at power ON. This function gives you a quick visual introduction to the function display indicators.

- ① While pushing [SUB], [FM] and [SSB/CW], push [POWER] IN to turn power ON.
 - The transceiver cycles through a visual tour of the function display indicators.
- ② Push any switch to exit demonstration mode and enter the normal operating condition temporarily.
 - The transceiver automatically returns to demonstration mode after 2 min. in which no operations are performed.
 - The condition remains activated even when the power is turned OFF and ON again. Perform step ① to cancel demonstration mode.

15 SPECIFICATIONS

■ GENERAL

- Frequency coverage :

Version	VHF	UHF
U.S.A.	Rx: 136.0–174.0 MHz* Tx: 144.0–148.0 MHz	430.0–450.0 MHz
Europe	144.0–146.0 MHz	430.0–440.0 MHz
Australia	144.0–148.0 MHz	430.0–450.0 MHz
Sweden	144.0–146.0 MHz	432.0–438.0 MHz

* Guaranteed range is 144.0–148.0 MHz.

- Mode : SSB (A3J), CW (A1), FM (F3)
- Number of memory channels : 176
(80 regular, 1 call 2 scan edges for each band and 10 satellite memories)
- Antenna connectors : SO-239/50 Ω (for VHF band)
Type-N/50 Ω (for UHF band)
- Usable temperature range : -10°C to $+60^{\circ}\text{C}$; $+14^{\circ}\text{F}$ to $+140^{\circ}\text{F}$
- Frequency stability : ± 3 ppm (-10°C to $+60^{\circ}\text{C}$)
- Power supply requirement : 13.8 V DC $\pm 15\%$
(negative ground)
- Current drain (at 13.8 V DC) : Transmit Max. power 16.0 A
Receive Max. audio 2.5 A
Standby 2.0 A
- Dimensions : 241(W) \times 94(H) \times 239(D) mm
9 1/2(W) \times 3 11/16(H) \times 9 13/32(D) in
(projections not included)
- Weight : 5.0 kg; 11.0 lb

■ TRANSMITTER

- Output power (continuously adjustable):
VHF SSB 6–35 W
FM/CW 6–45 W
UHF SSB 6–30 W
FM/CW 6–40 W
- Spurious emissions : Less than -60 dB
- Carrier suppression : More than 40 dB
- Unwanted sideband : More than 40 dB
- Microphone connector : 8-pin connector (600 Ω)

■ RECEIVER

- Receive system
VHF SSB, CW Single conversion superheterodyne
FM Double conversion superheterodyne
UHF SSB, CW Double conversion superheterodyne
FM Triple conversion superheterodyne
- Intermediate frequencies: (Unit: MHz)

	Mode	MAIN band			SUB band		
		1st	2nd	3rd	1st	2nd	3rd
VHF	SSB	10.8500	–	–	10.9500	–	–
	CW	10.8491	–	–	10.9491	–	–
	FM	10.8500	0.4550	–	10.9500	0.4550	–
UHF	SSB	71.2500	10.8500	–	71.3500	10.9500	–
	CW	71.2491	10.8491	–	71.3491	10.9491	–
	FM	71.2500	10.8500	0.4550	71.3500	10.9500	0.4550

- Sensitivity (both VHF and UHF bands):
SSB, CW 0.11 μV for 10 dB S/N
FM 0.18 μV for 12 dB SINAD
- Squelch sensitivity (both VHF and UHF bands):
SSB, CW Threshold Less than 1.0 μV
Tight Less than 3.2 mV
FM Threshold Less than 0.1 μV
Tight Less than 3.2 mV
- Selectivity :
SSB, CW More than 2.3 kHz/ -6 dB
Less than 4.2 kHz/ -60 dB
CW-Narrow More than 0.5 kHz/ -6 dB
(optional) Less than 1.34 kHz/ -60 dB
FM More than 15.0 kHz/ -6 dB
Less than 30.0 kHz/ -60 dB
- Spurious and image : More than 60 dB rejection ratio
- Audio output power : More than 2.0 W at 10% distortion
(at 13.8 V DC) with an 8 Ω load
- RIT variable range :
SSB, CW More than ± 1.0 kHz
FM More than ± 5.0 kHz
- IF shift variable range : More than ± 1.2 kHz

PS-85 DC POWER SUPPLY

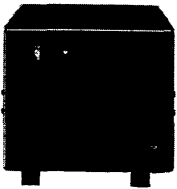

The style and size are matched with the IC-821H.

Output : 13.8 V DC / 20 A

PS-30 DC POWER SUPPLY
(for U.S.A. and Australia versions only)

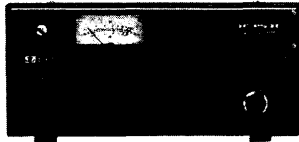

A lightweight switching regulator. System power supply with 3 output connectors.

Output : 13.8 V DC / 25 A

AG-25 (144 MHz band)
AG-35 (430 MHz band)
WEATHERPROOF
PREAMPLIFIERS

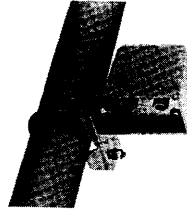

External all-weather, mast-mounting preamplifiers for compensating for coaxial cable loss.

SP-21
EXTERNAL SPEAKER

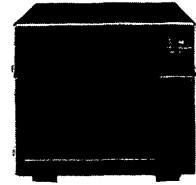

Designed for base station operation.

Input : 5 W / 8 Ω

SP-20 EXTERNAL SPEAKER

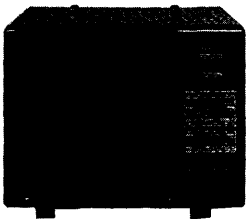

Equipped with 4 types of audio filters. 1 headphone jack and 2 selectable input connectors.

Input : 5 W / 8 Ω

SP-7 EXTERNAL SPEAKER

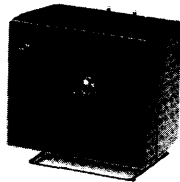

Compact speaker for base station operation. Height adjustable.

Input : 5 W / 8 Ω

IC-SP3
EXTERNAL SPEAKER

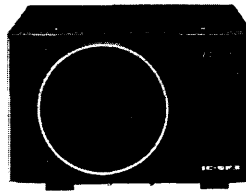

Large diameter speaker for high quality audio output.

Input : 4 W / 8 Ω

SM-20
DESKTOP MICROPHONE



Unidirectional, electret condenser microphone with heavy base. Includes [UP]/[DOWN] switches and low cut function.

HM-12, HM-14
HAND MICROPHONE

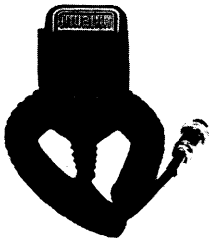

Hand microphone equipped with the [UP]/[DOWN] switches. The HM-14 has DTMF keypad.

CR-293 HIGH-STABILITY
CRYSTAL UNIT

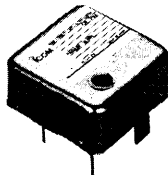

Frequency stability:
 ± 0.5 ppm (0 $^{\circ}$ C to +60 $^{\circ}$ C;
-14 $^{\circ}$ F to +140 $^{\circ}$ F)

FL-132 (for main band)
FL-133 (for sub band and satellite mode)
CW NARROW FILTERS

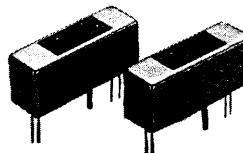

Have good shape factor and provide better CW reception during crowded band conditions. 500 Hz / -6 dB

CT-17
CI-V LEVEL CONVERTER



Level converter to connect the transceiver to an RS-232C port of a computer for remote control.

MB-23 CARRYING HANDLE



Carrying handle for easy portable operation. Use screws included with the transceiver.

IC-MB5 MOBILE MOUNTING
BRACKET

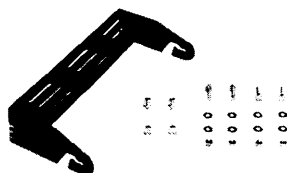

Mounting bracket for installing the transceiver in your vehicle, boat, etc.

UT-84 TONE SQUELCH UNIT
Provides a "personalized" tone squelch system and tone scan.

UT-102
VOICE SYNTHESIZER UNIT
Announces frequency, mode, and memory channel number.

Count on us!

