

TECHNICAL DOCUMENTS

FOR

COURRIER ARRIVÉ LE

- 3 JAN. 1997

82.

PRESIDENT
ELECTRONICS

PRESIDENT RANDY

FOR

AFTER SERVICE

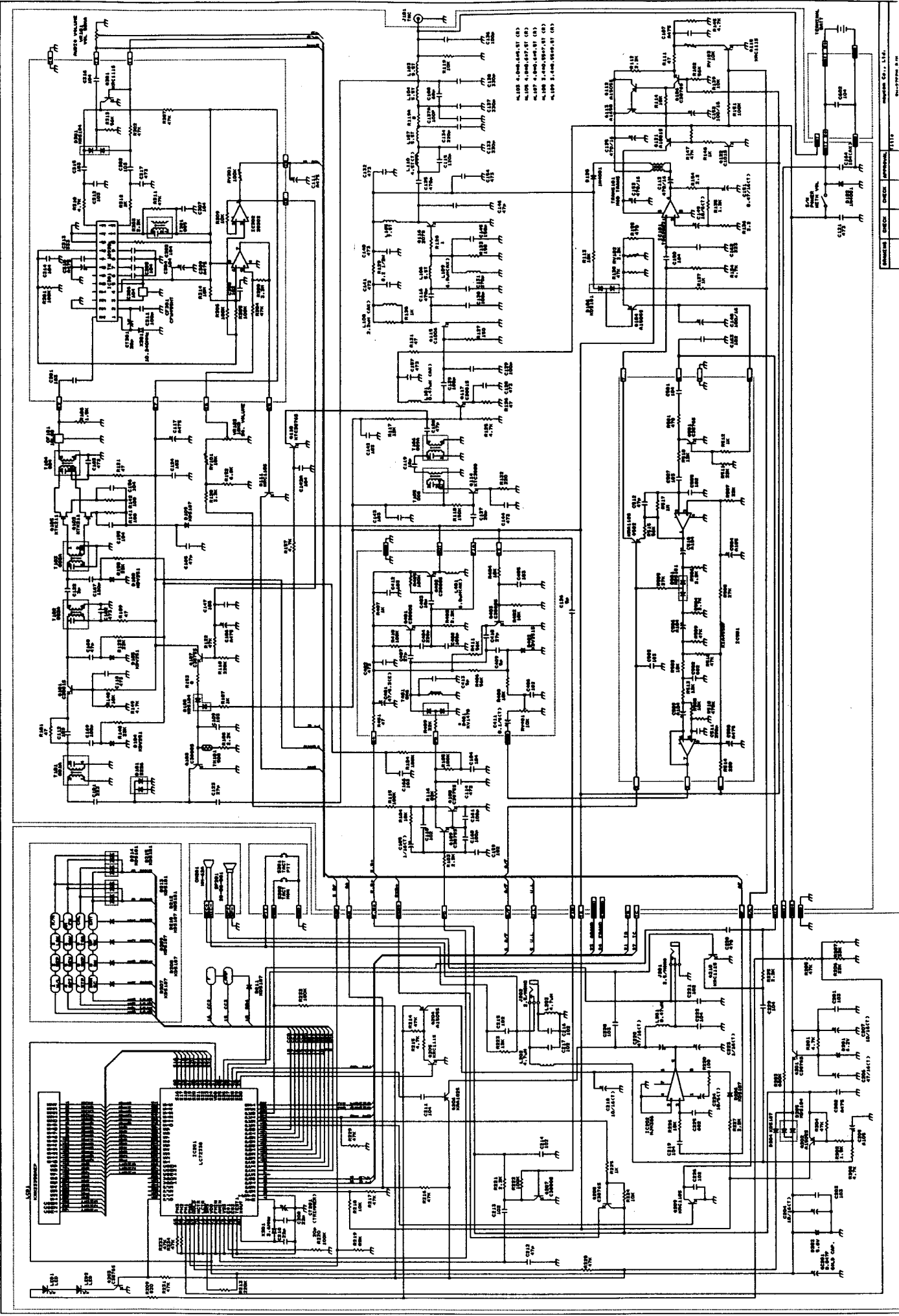

W. 100 4.000.000.001 (C)
 W. 100 4.000.000.002 (C)
 W. 100 4.000.000.003 (C)
 W. 100 4.000.000.004 (C)

TOP SILK

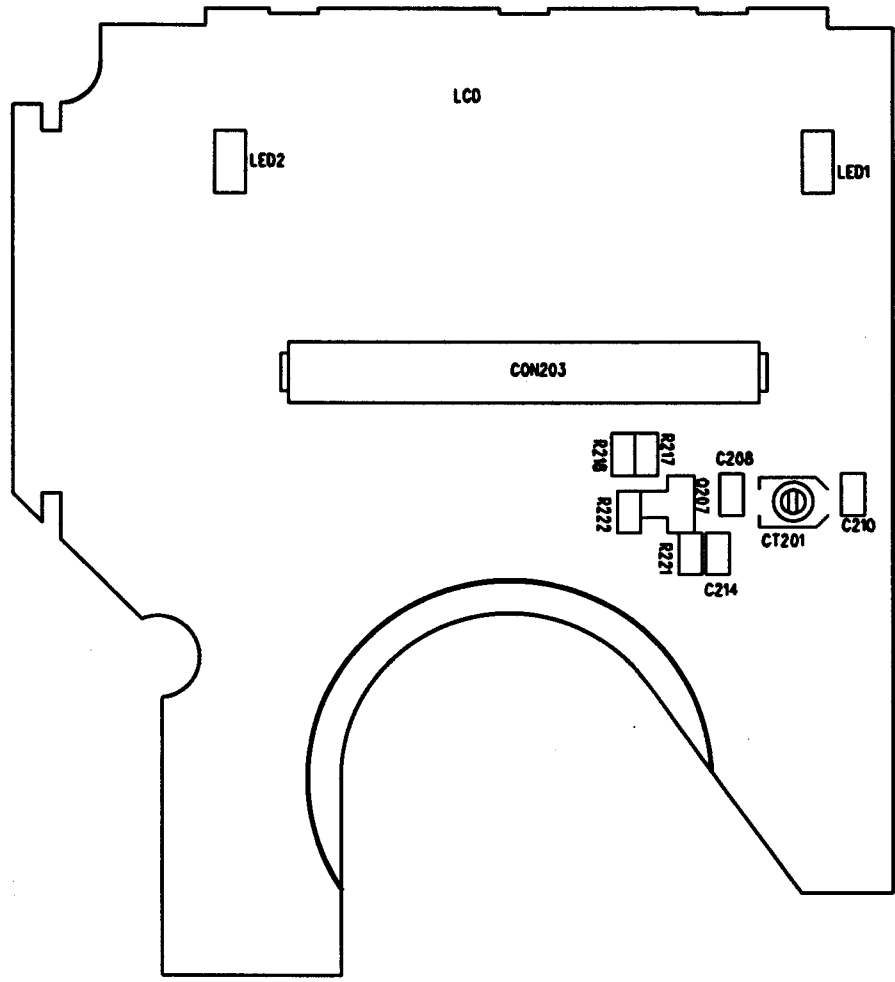

MAYCOM SH27-CPU 1996,11,29 REV.3 KIM.H.J

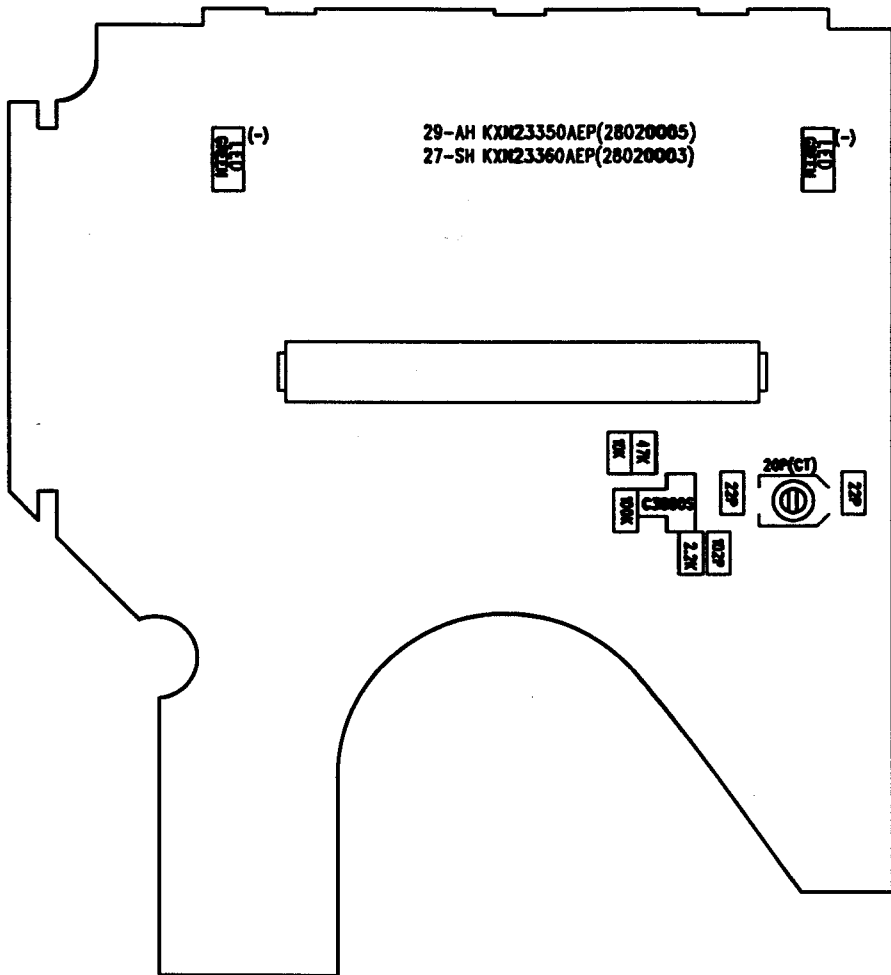

MAYCOM SH27-CPU 1996,11,29 REV.3 KIM.H.J

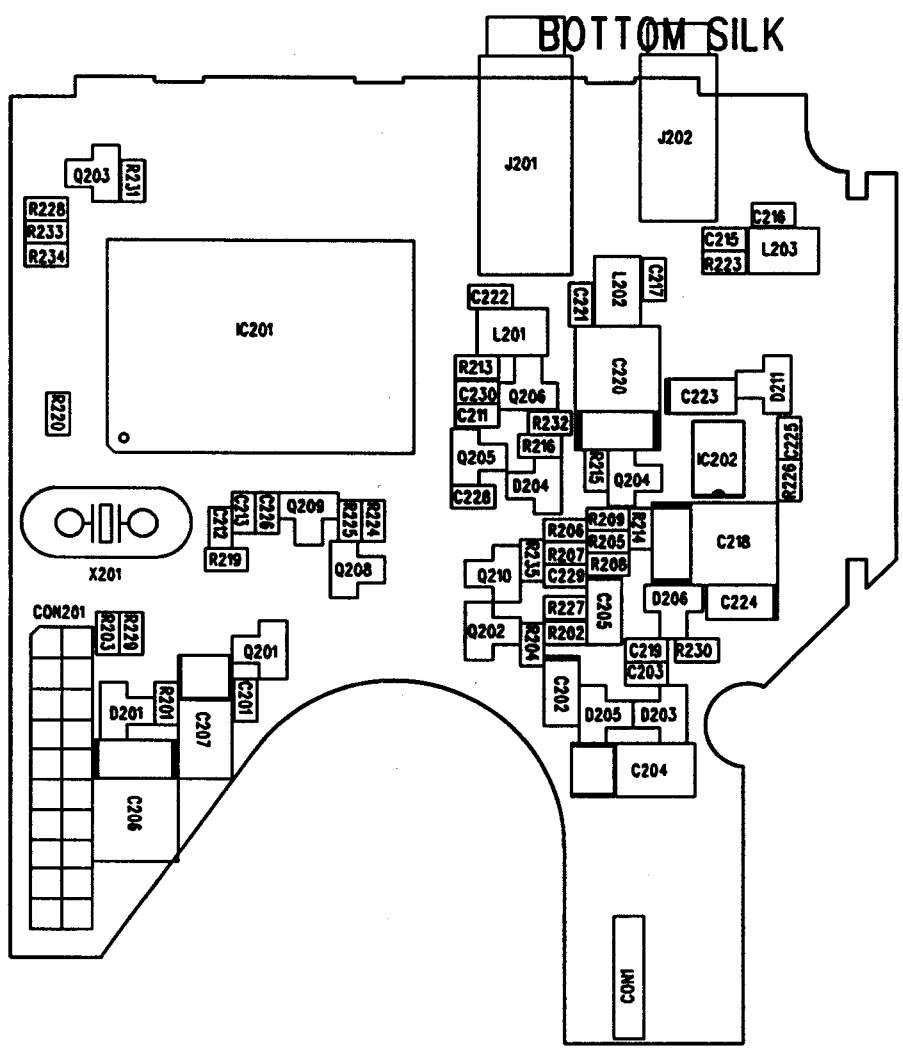

MAYCOM SH27-CPU 1996,11,29 REV.3 KIM.H.1

TOP PATTERN

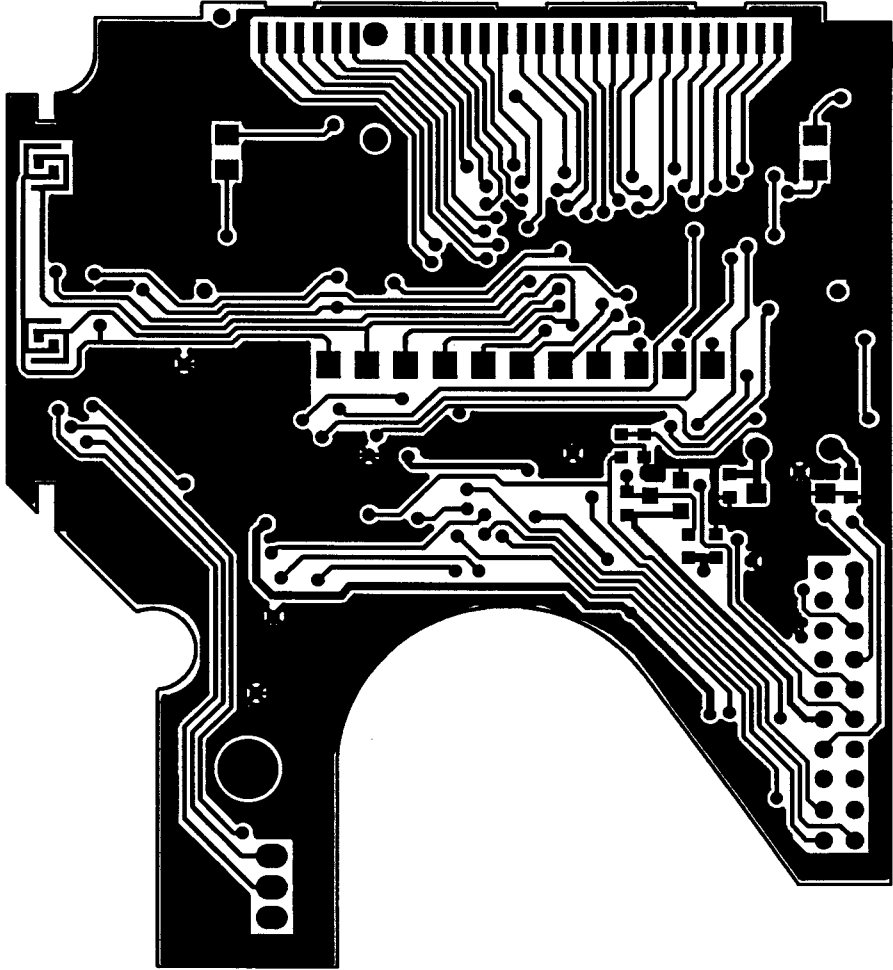

MAYCOM SH27-CPU 1996,11,29 REV.3 KIM.H.J

BOTTOM PATTERN

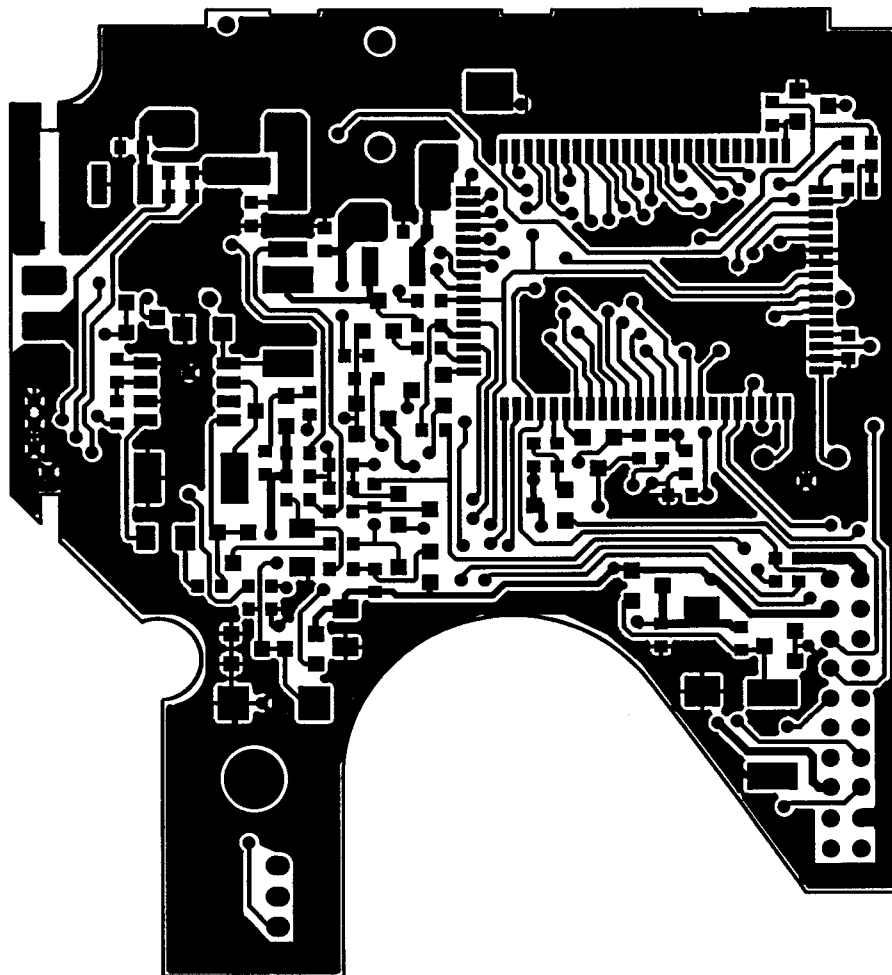

MAYCOM SH27-CPU 1996,11,29 REV.3 KIM.H.J

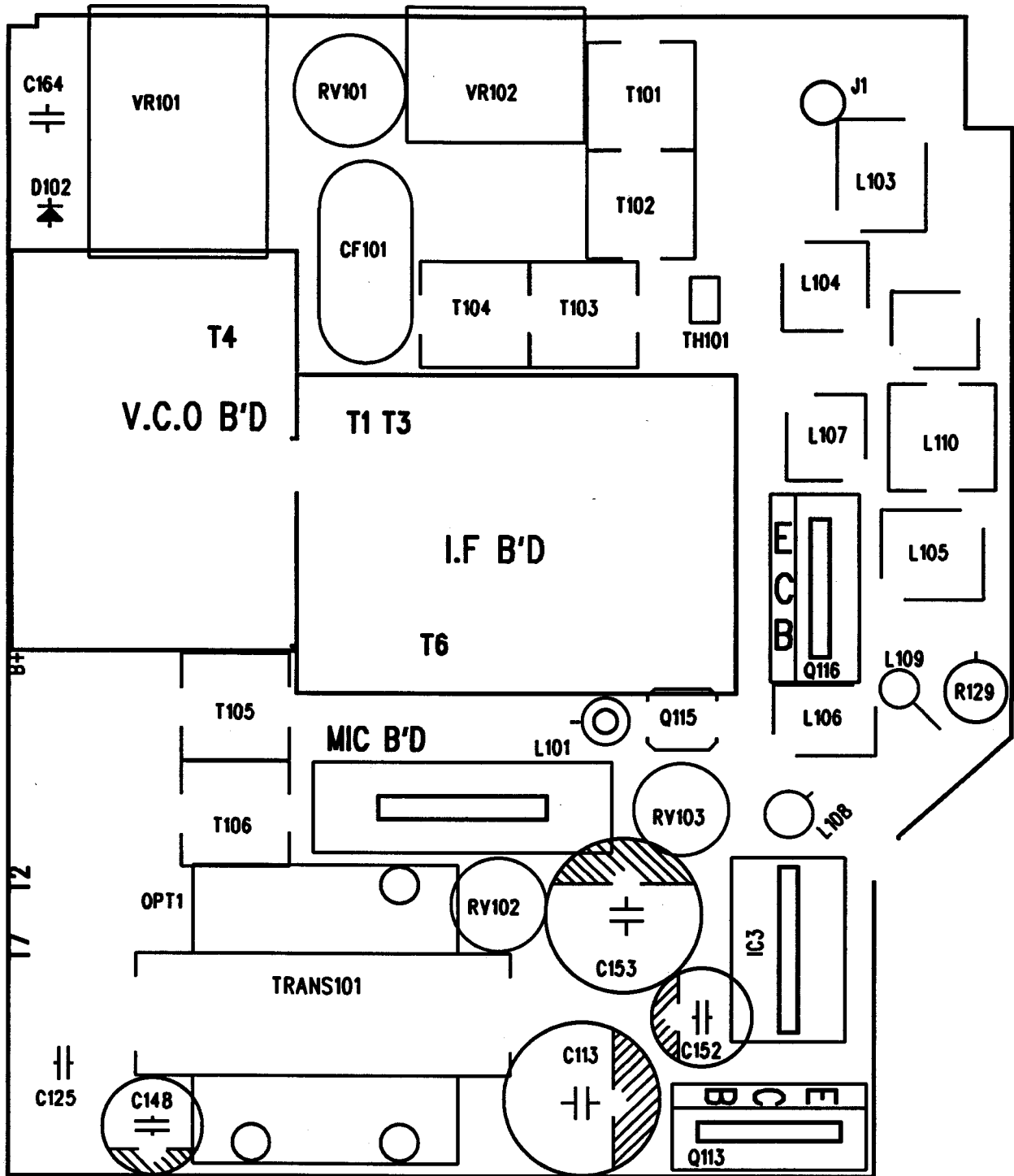

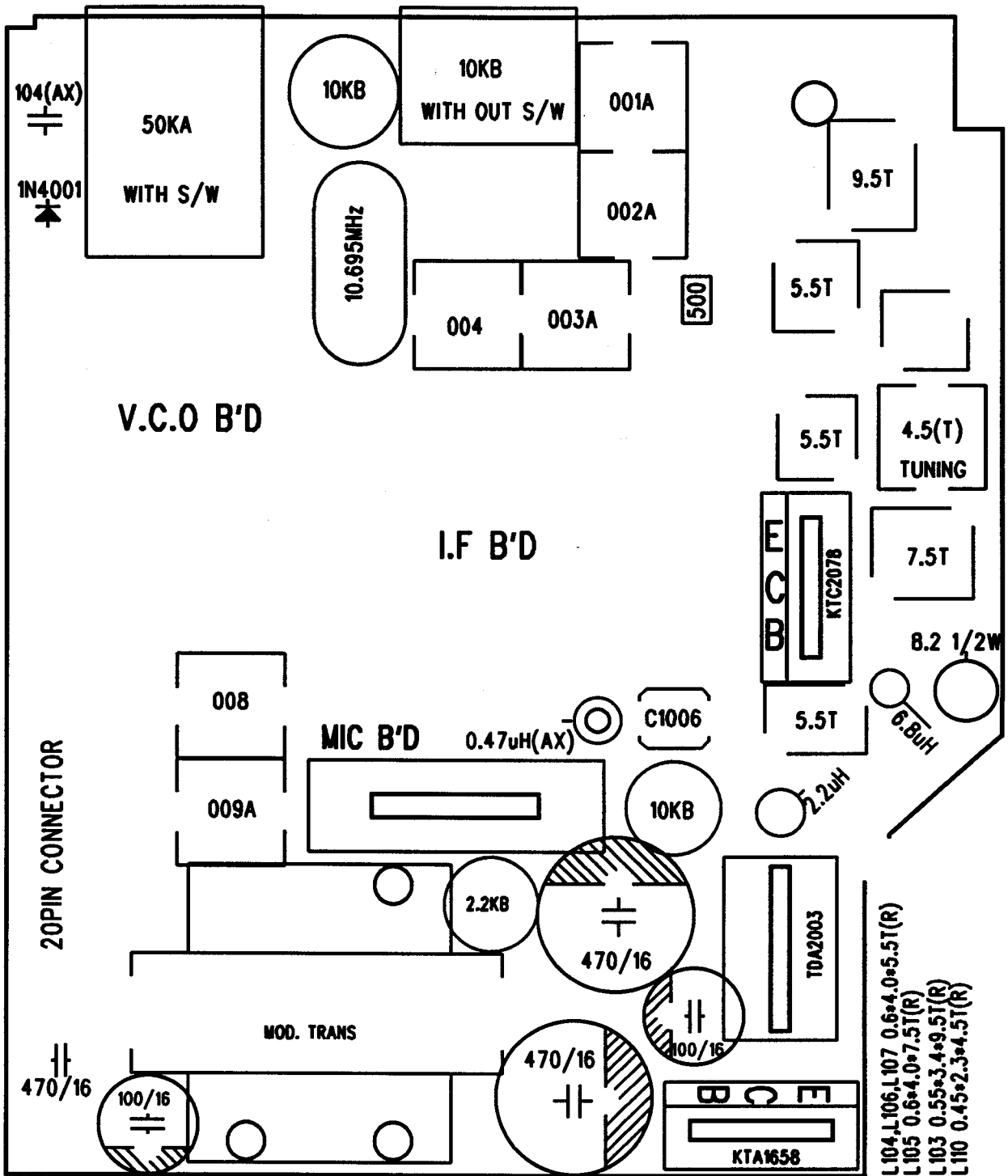

- L104 1.106L107 0.6*4.0*5.5T(R)
- L105 0.9*4.0*7.5T(R)
- L103 0.55*3.4*9.5T(R)
- L110 0.45*2.3*4.5T(R)

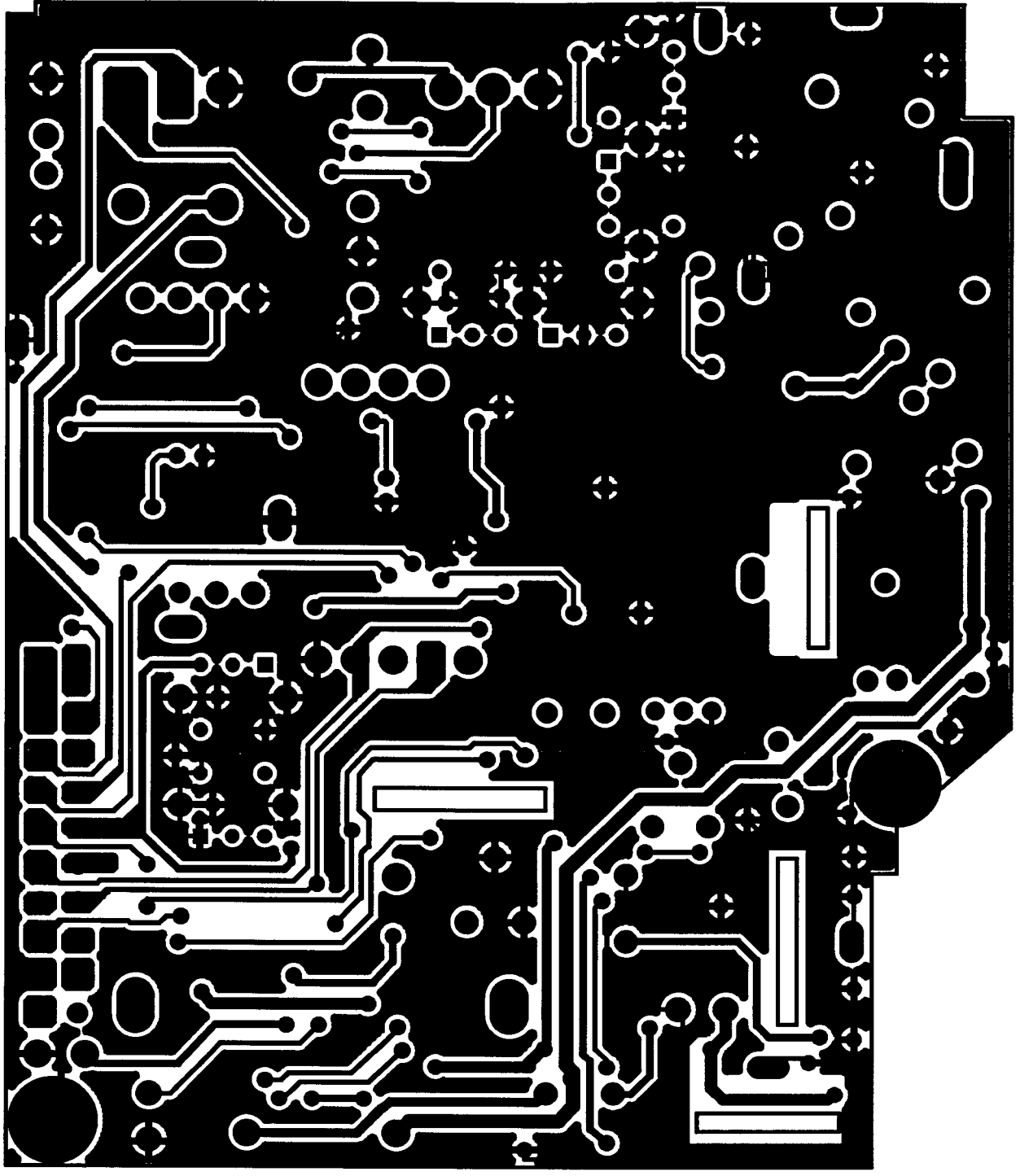

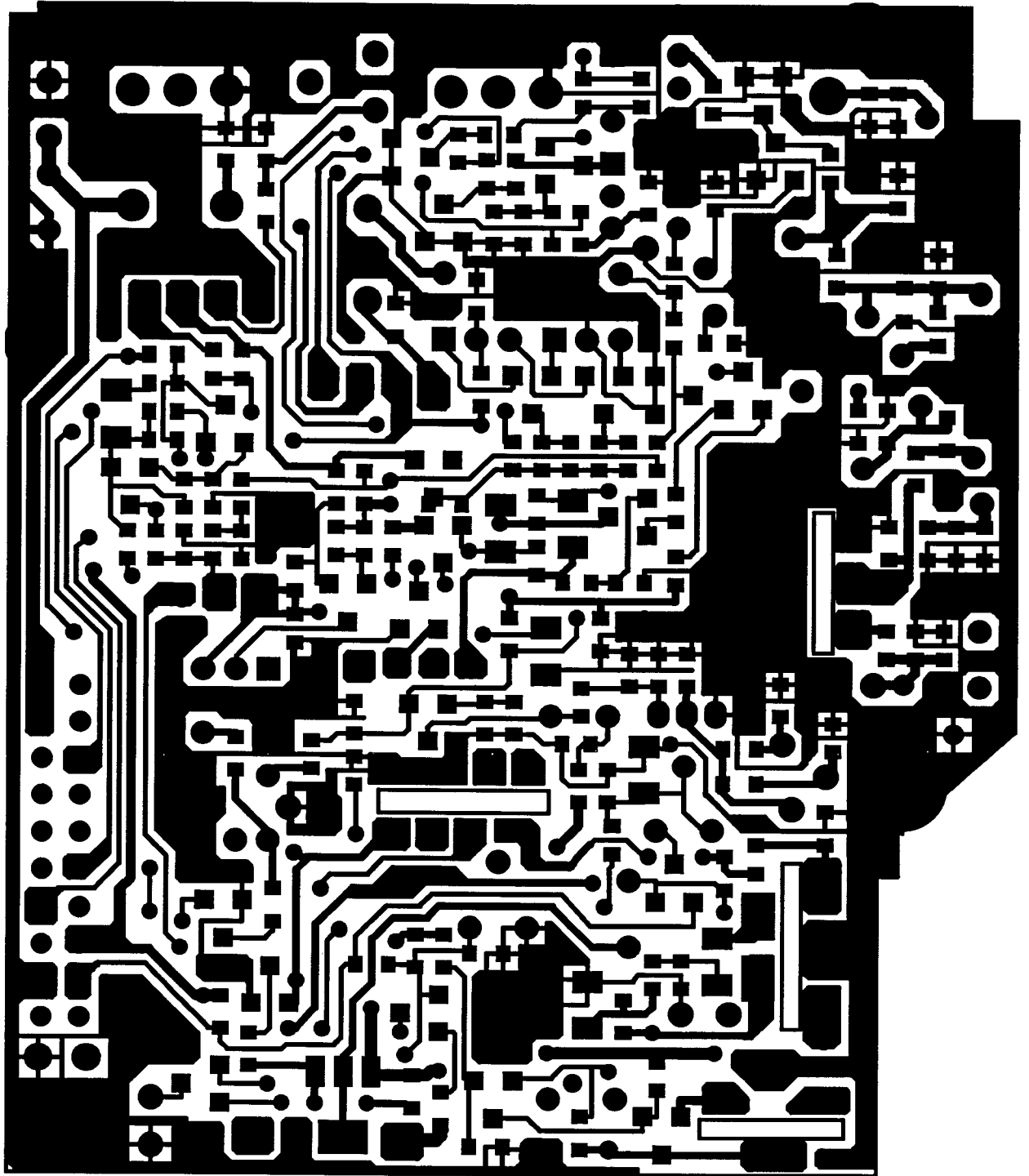

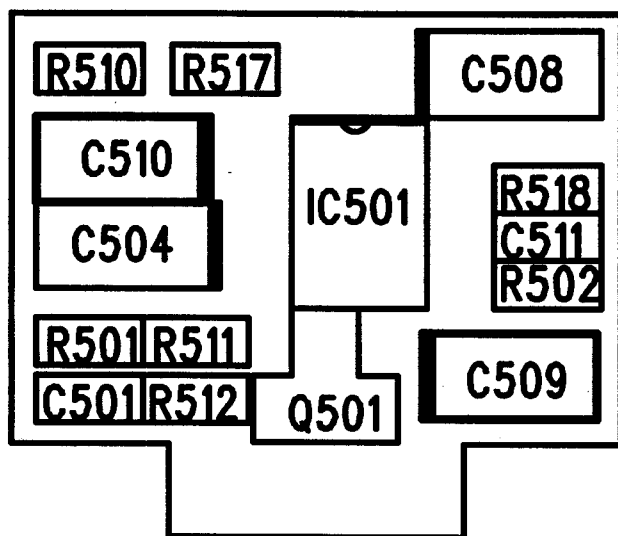

MAYCOM
AH29-MIC

top sode silk screen

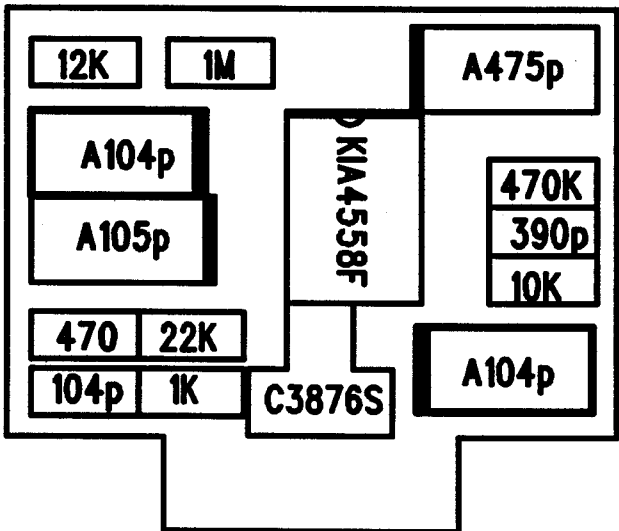

MAYCOM
AH29-MIC

MOJYAM
AHSA-MIC

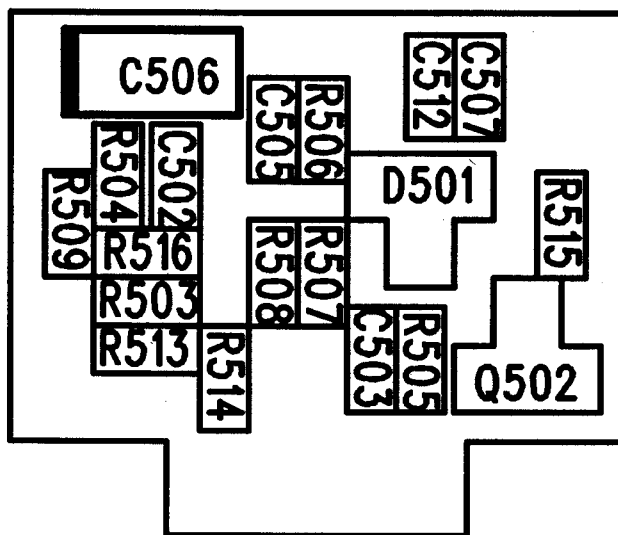

bottom side silk screen

MOJYAM
AHSA-MIC

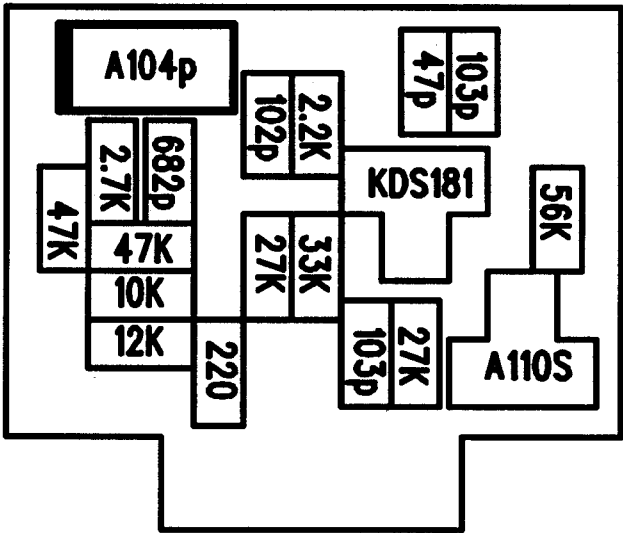

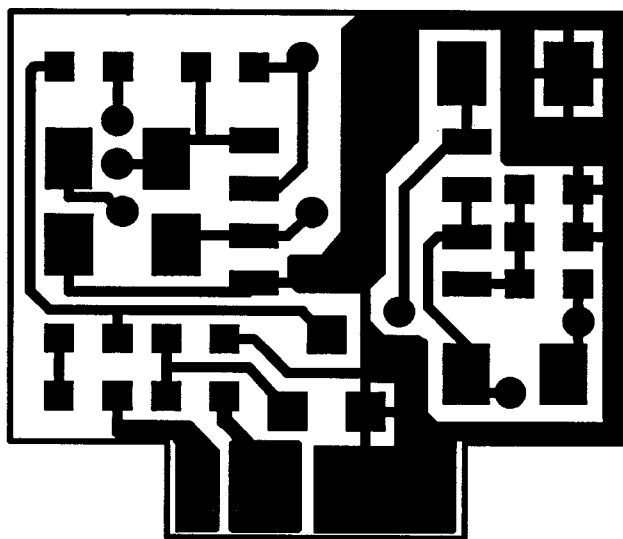

MAYCOM
AH29-MIC

top side pattern

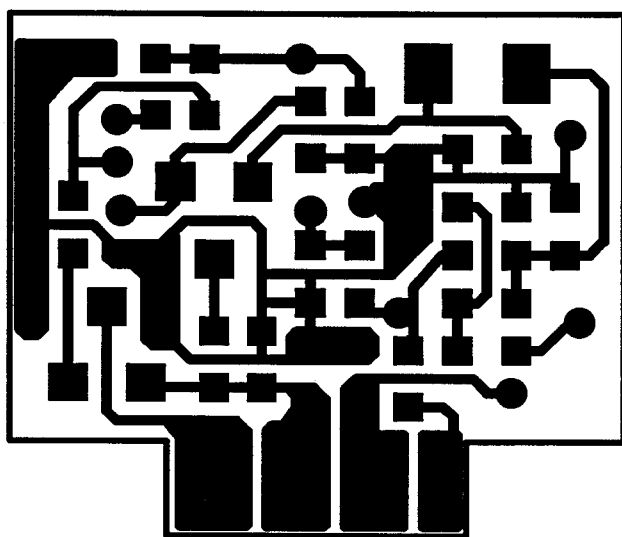

MAYCOM
AH29-MIC

bottom side pattern

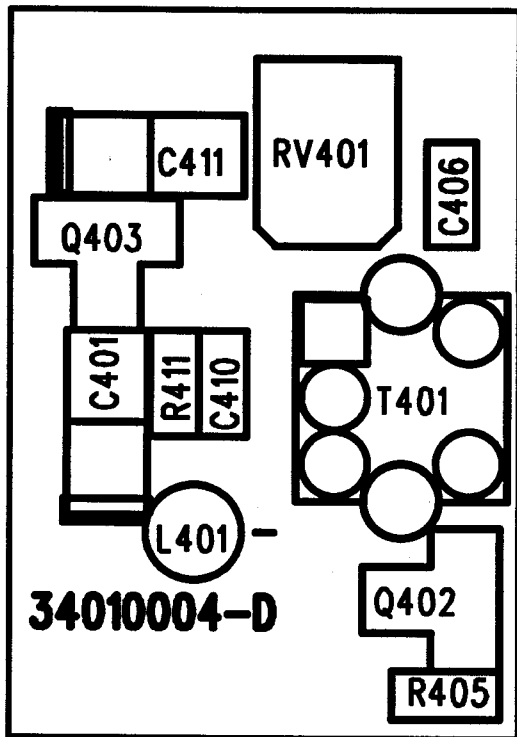

MAYCOM
AH29-VC0

TOP SIDE SILK SCREEN

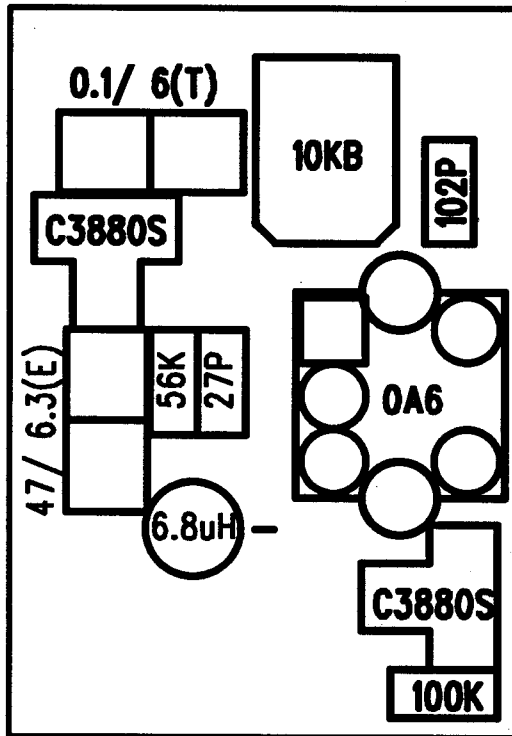

MAYCOM
AH29-VCO

MOJYAM
OJV-ESHA

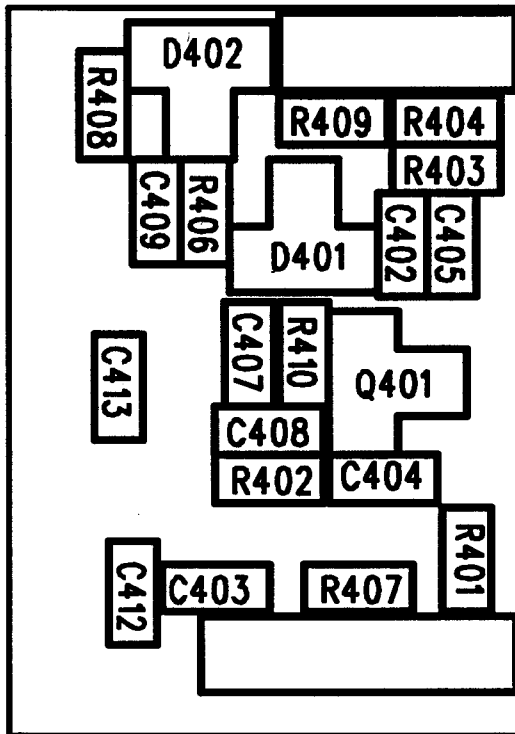

BOTTOM SIDE SILK SCREEN

MOJYAM
OJY-ASHA

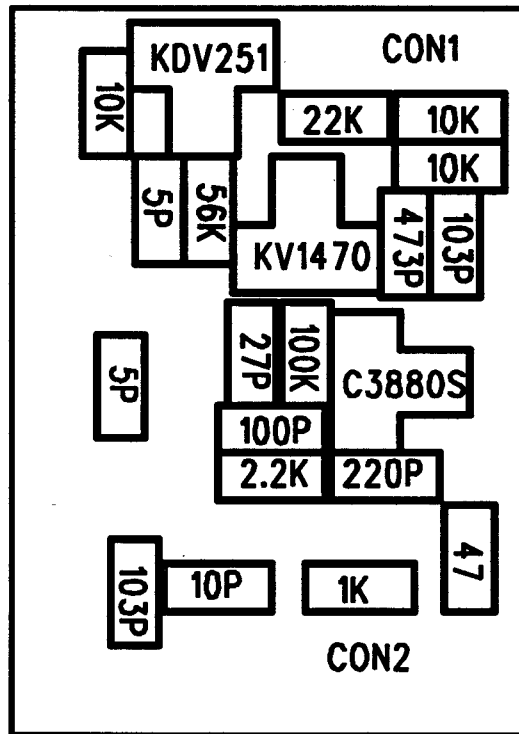

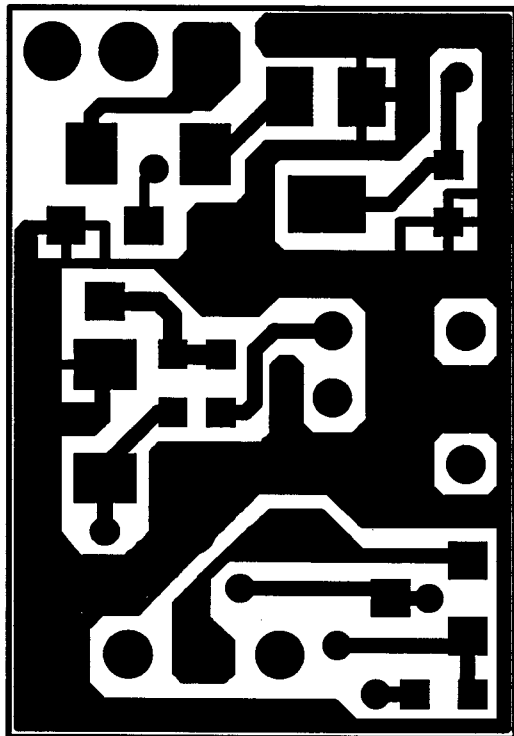

MAYCOM
AH29-VCO

TOP SIDE PATTERN

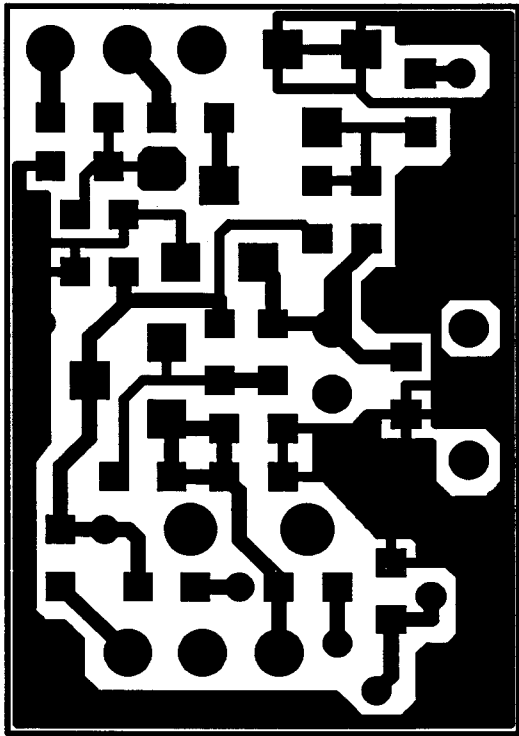

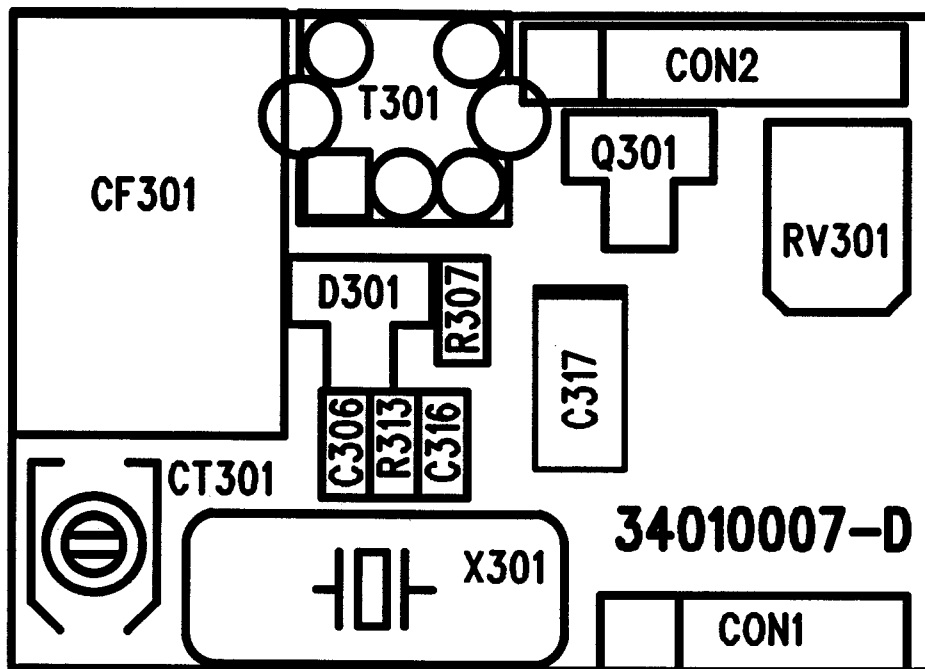

- top side silk screen -

MAYCOM

AH-27 IF

1996,07,26

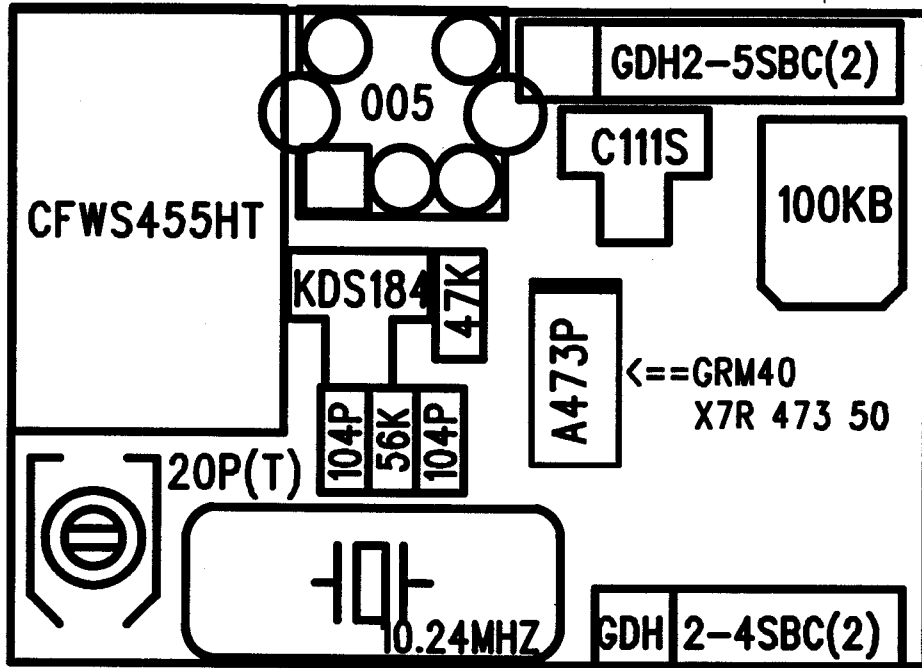

-
 MAYCOM
 AH-27 IF
 1996,07,26

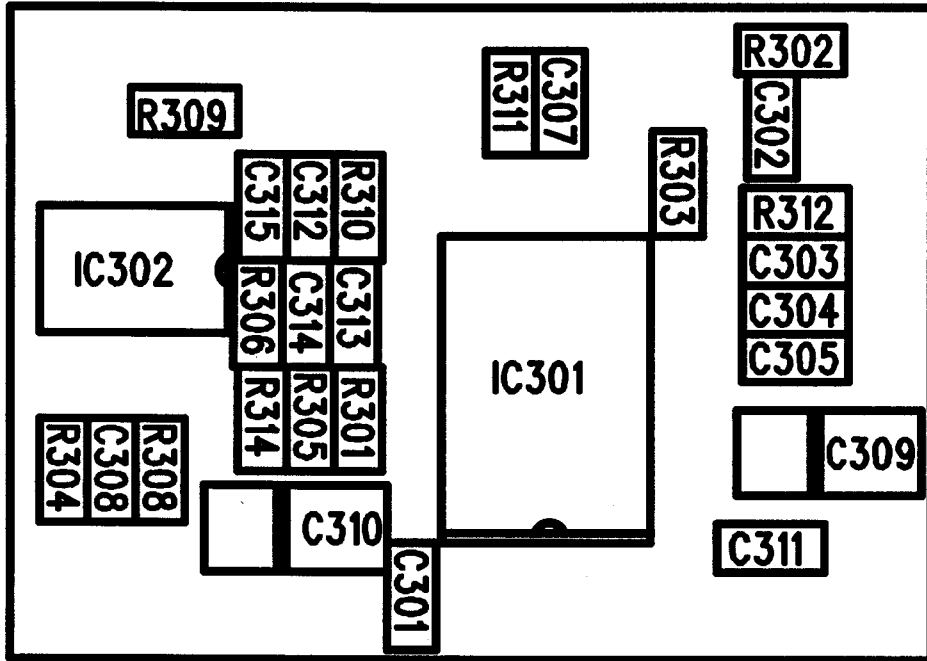

- bottom side silk screen -

1998, 07, 28
 AH-SJ IF
 MAYCOM
 MOYAM

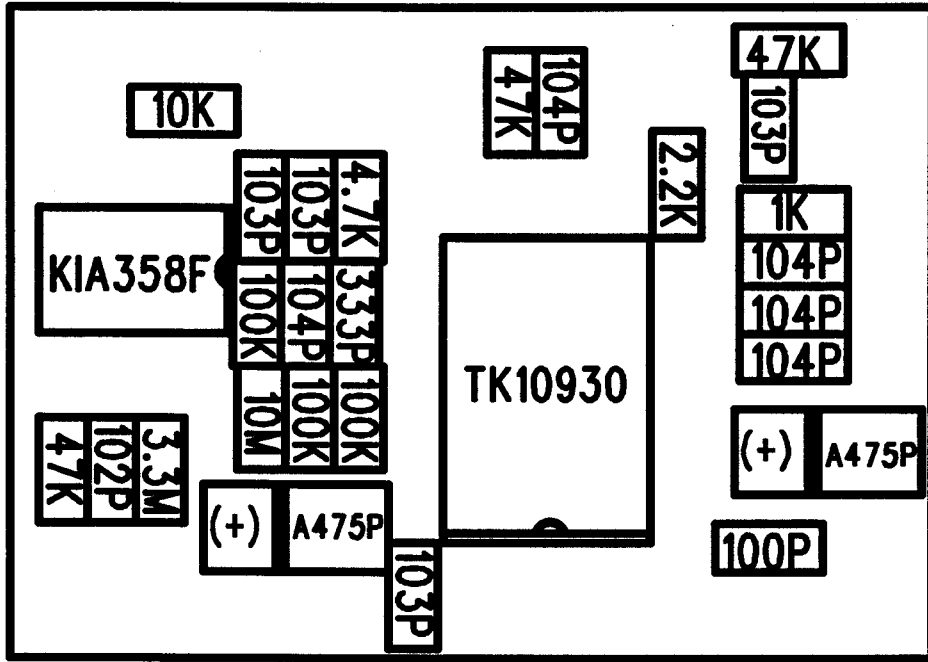

1998.07.28
 AH-57 IF
 MAYCOM

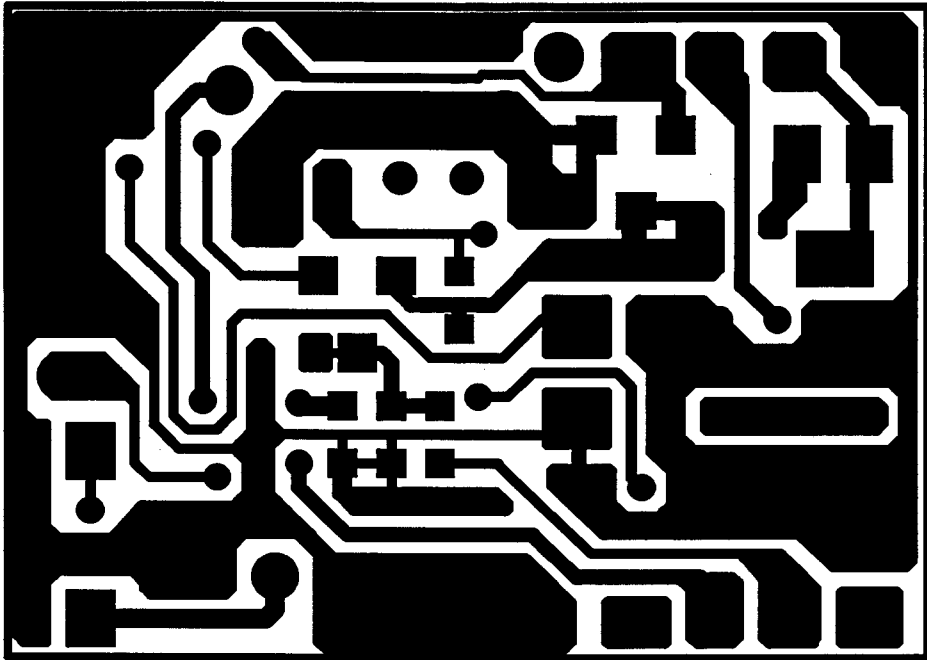

- top side pattern -

MAYCOM

AH-27 IF

1996,07,26

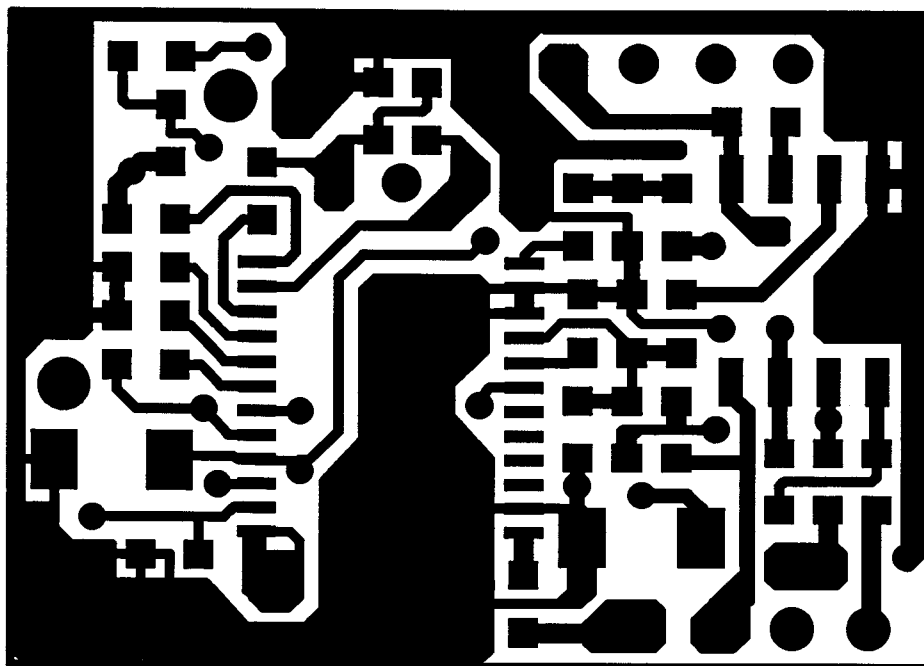

- bottom side pattern -

MAYCOM
AH-27 IF
1996,07,26

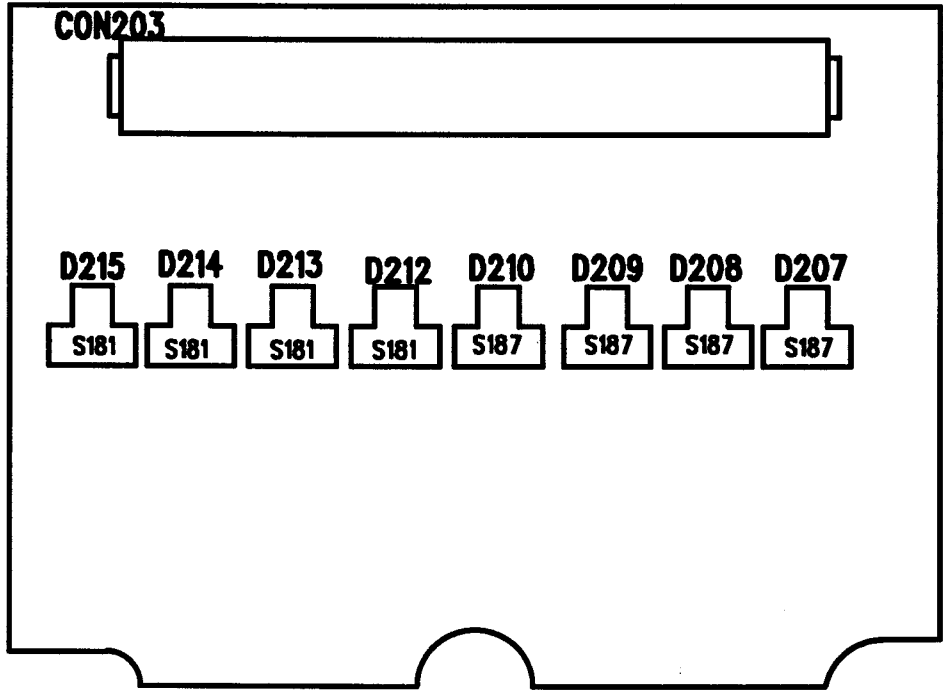

MAYCOM AH-Sa(KEY)

BOTTOM SILK

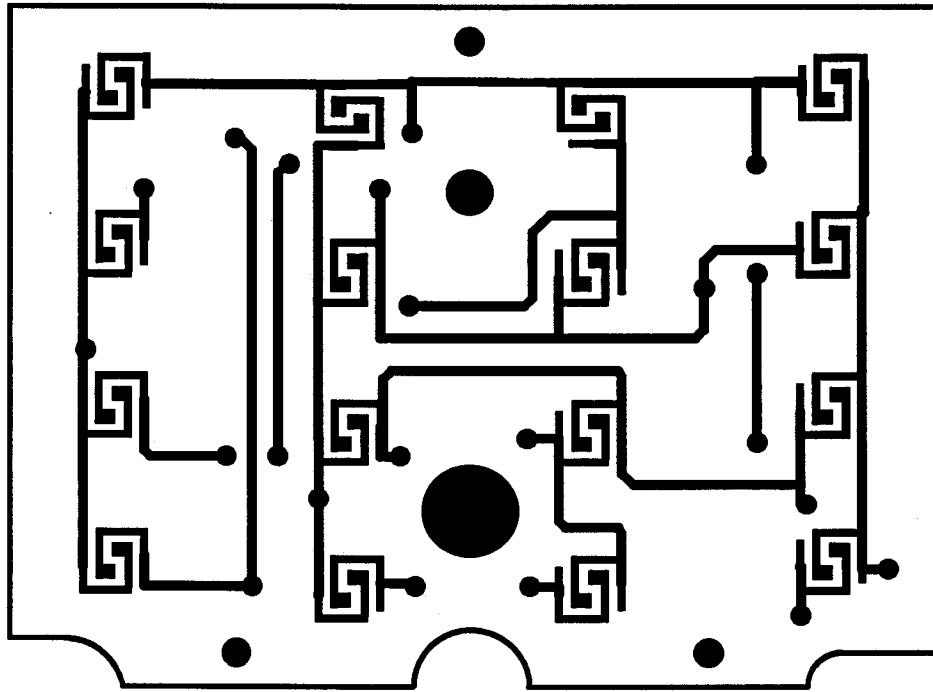

MAYCOM SH-27(KEY)

1996,03,06

REV.0

H.J.KIM

TOP PATTERN

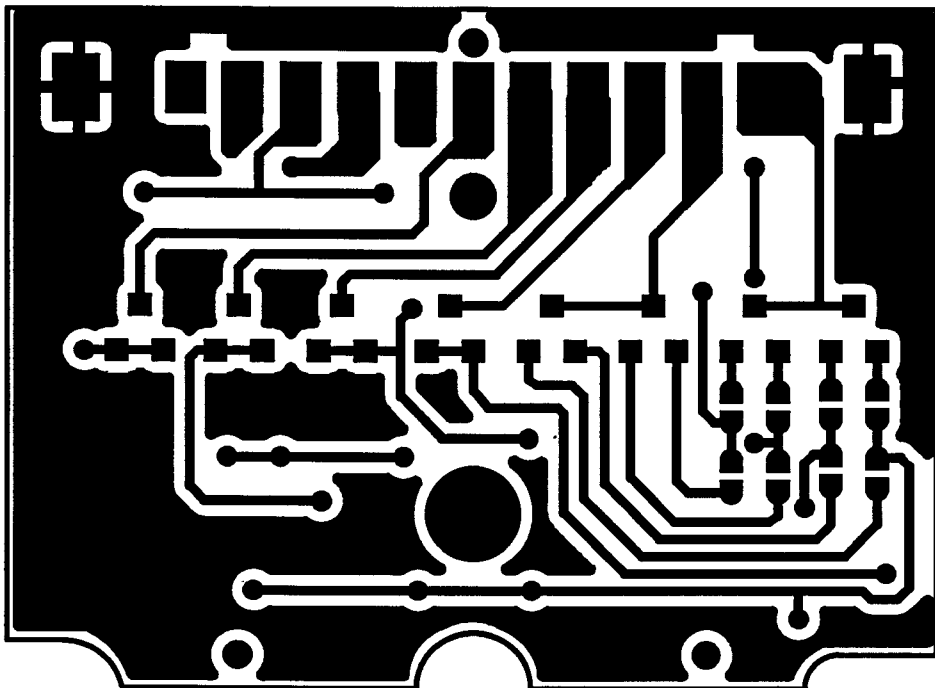

MAYCOM SH-27(KEY)
1996,03,06
REV.0
H.J.KIM BOTTOM PATTERN

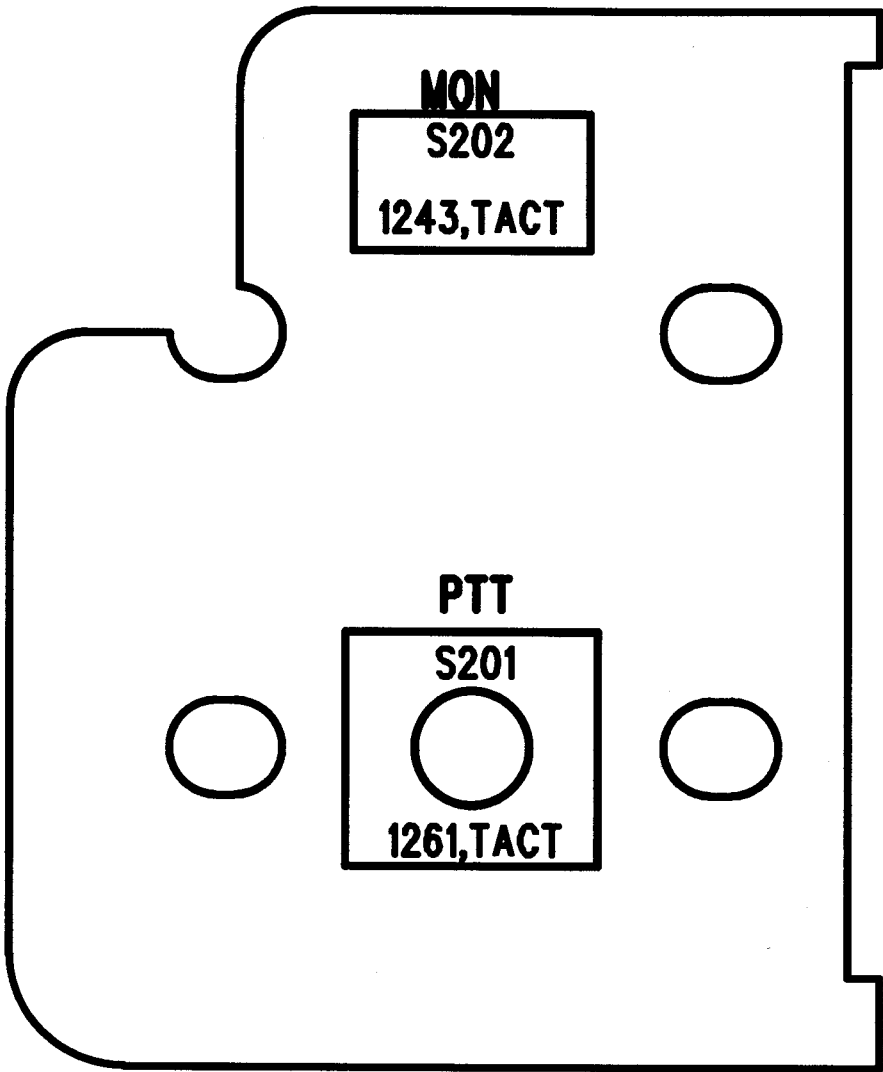

MAYCOM
AH29-PTT

TOP SILK SCREEN

MAYCOM
AH29-PTT

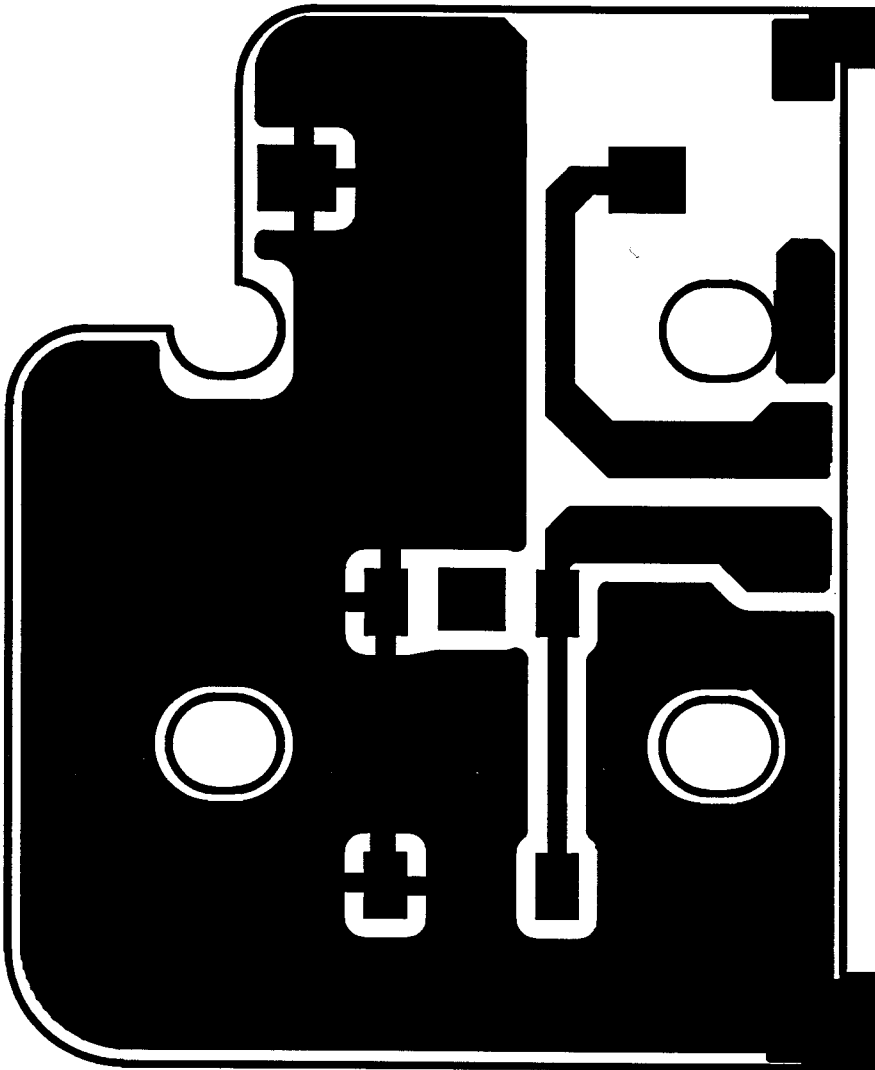

TOP PATTERN

MAYCOM
AH29-PTT

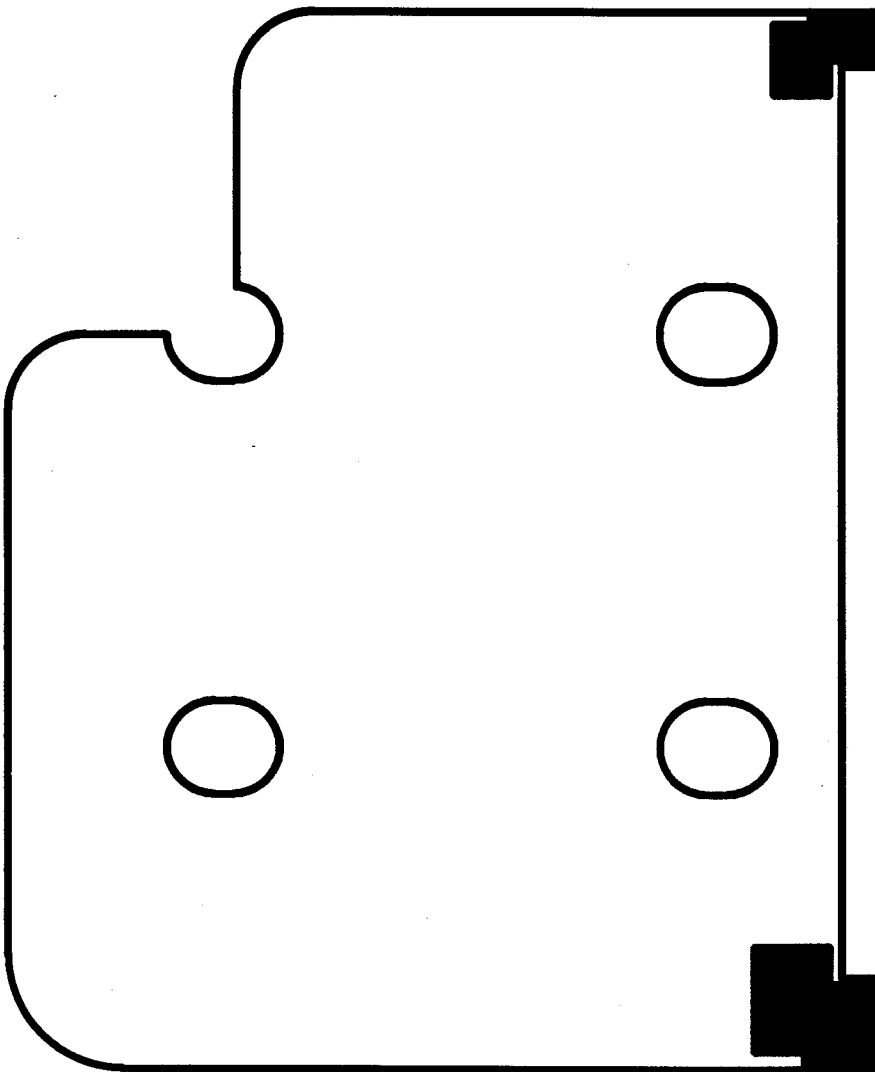

BOTTOM PATTERN

TOP PATTERN

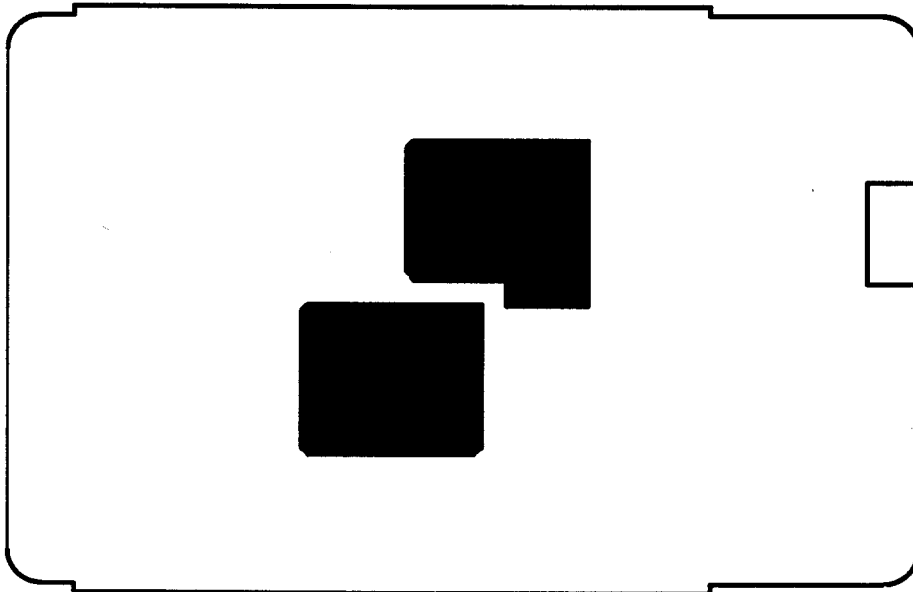

MAYCOM
SH27-TERMINAL
1995,09,14

BOTTOM PATTERN

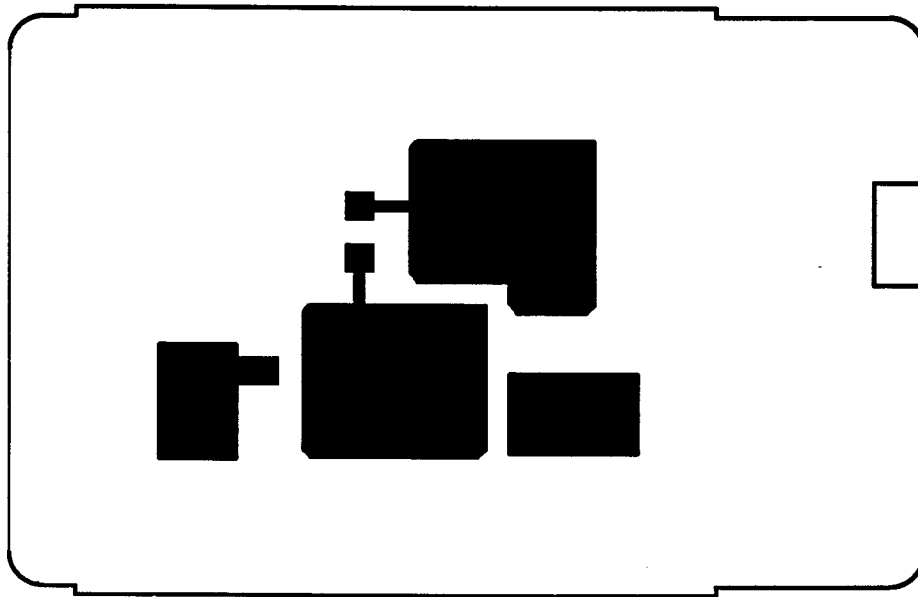

MAYCOM

SH27-TERMINAL

1995,09,14