

# HTX-100

## 10-METER SSB/CW MOBILE TRANSCEIVER

Please read before operating this transceiver

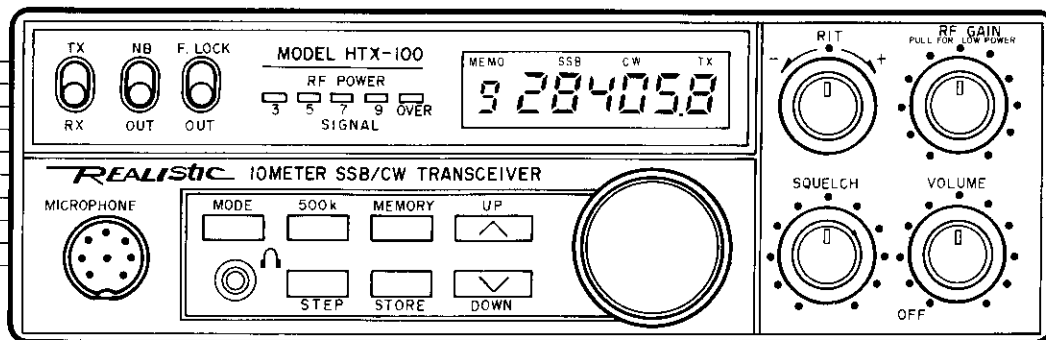

# INTRODUCTION

---

Your Realistic® HTX-100 10-Meter SSB/CW Mobile Transceiver is one of the most technologically advanced 10-meter transceivers available today. It is a perfect choice for a novice's first ham radio, or as an addition to an established ham operator's equipment. We designed your transceiver to be compact, durable, and ideal for mobile applications.

Although we made the HTX-100 transceiver small, we packed it with these advanced features:

**RIT (Receiver Incremental Tuning) Control** — permits you to fine tune the receiver to match the received signal.

**10 Memory Channels** — make it easy to switch to the popular frequencies in your area.

**High or Low Output Power** — lets you switch between 25 Watts and 5 Watts of output power.

**RF GAIN Control** — allows you to increase or reduce the amount of gain for received signals.

**CW and SSB Modes** — allow you to send Morse code (CW) or communicate by voice on the upper side band.

**Note:** You must have an FCC Radio Amateur Operator's License to legally transmit using your transceiver. Transmitting without a license carries heavy penalties.

**Caution:** We do not warrant your transceiver to be waterproof. If you use your transceiver around water, take care to prevent moisture from getting inside it.

For your important records, we urge you to record the serial number of your transceiver in the space provided below. You will find the serial number on the back panel of the transceiver.

Serial Number: \_\_\_\_\_

©1988 Tandy Corporation.  
All Rights Reserved.

Realistic and Radio Shack are registered trademarks of Tandy Corporation.

# A QUICK LOOK AT YOUR TRANSCEIVER

## FRONT PANEL

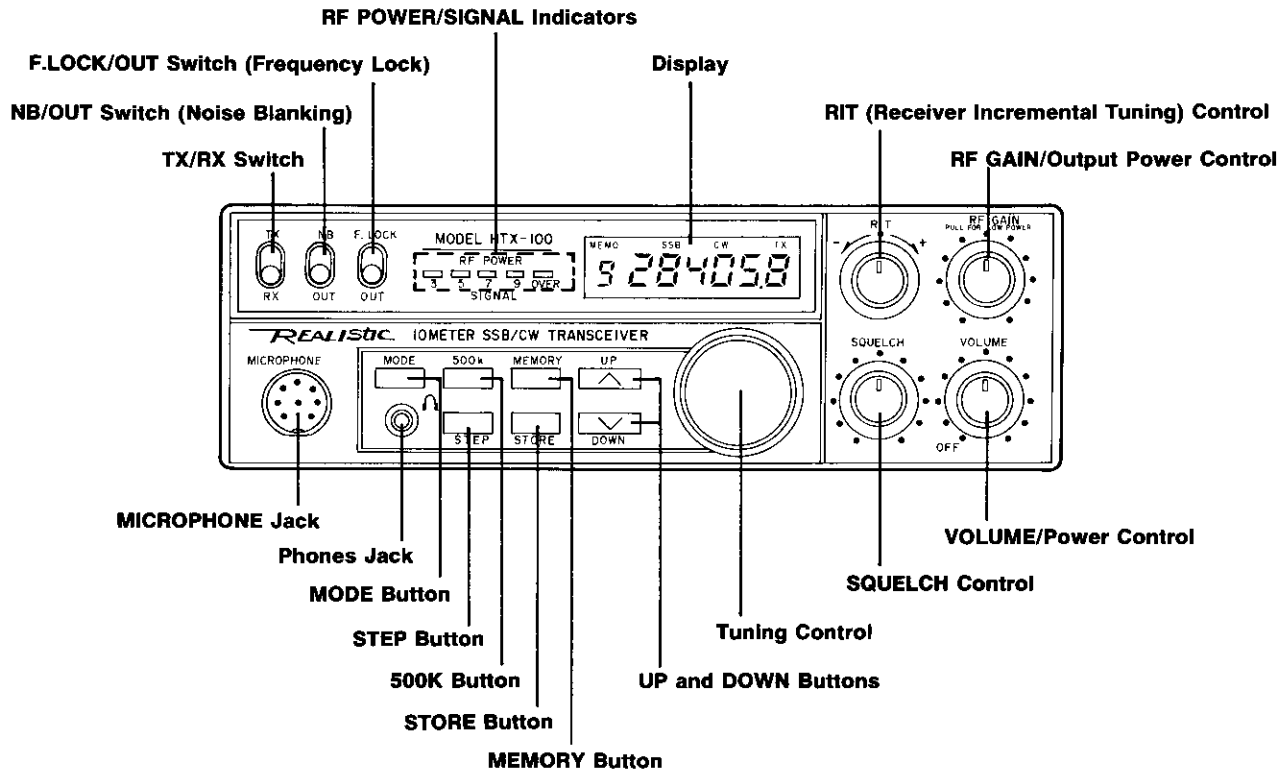

---

---

## BACK PANEL

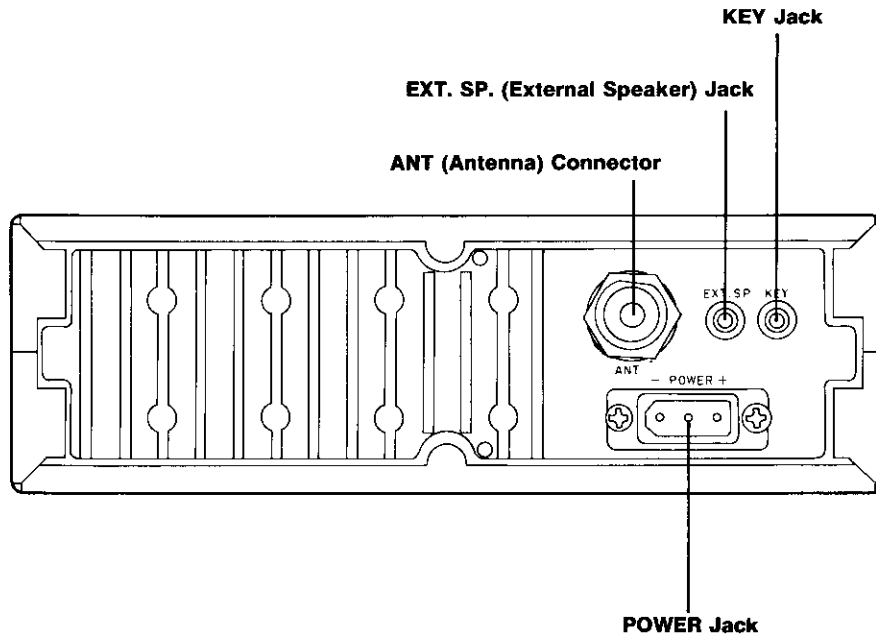

## MICROPHONE

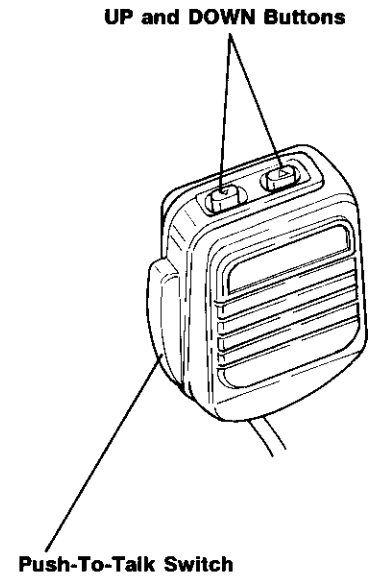

## INTRODUCTION TO AMATEUR RADIO

---

We designed your HTX-100 transceiver to be the perfect first radio for anyone entering the exciting world of amateur radio. From your car, home, or boat, you will find that your transceiver opens a door to the world — literally! All you need is a source of electricity, a suitable antenna, and, most important of all, an Amateur Radio Operator's License issued by the Federal Communications Commission (FCC).

You might already have a license. In fact, you might have been a ham operator for many years. But, if you do not have a license, you will find that it is easy to get one, and that there is much help available. Here are a few tips to help you get started.

First, go ahead and hook up your transceiver as described in the "Installation" section of this manual. Use the receiver to tune around on the band to see what is going on. **Do not even think of transmitting until you get your license!** That is very important. Transmitting without a license is a violation of Federal law that can lead to severe penalties. Also, ham operators take the FCC rules very seriously and want nothing to do with *bootleggers* — their term for people who operate without a license.

Second, find out if there is a ham radio club in your area. There are thousands of clubs across the country, so there is probably at least one in or near your own community. The people at the store where you bought your equipment might be able to tell you. If not, and if you do not hear anyone talking about a local club in your area as you tune around the band with your receiver, write to the American Radio Relay League (ARRL) for information on how to contact their local affiliate. Most clubs welcome newcomers and are glad to help you get your license.

Next, start studying for your license. Do not let the word study scare you, because most people can go from knowing absolutely nothing about amateur radio to passing the basic (Novice) class license exam in fewer than 40 hours of study spread out over a couple of weeks. The exam tests your knowledge of basic radio regulations, elementary radio theory, and slow speed Morse Code. Many clubs teach license classes (a fun and easy way to learn about amateur radio), and there are good books, cassette tapes, computer programs, and many other study aids available. The ARRL publishes a book, *Tune in the World with Ham Radio* which is usually packaged with two tape cassettes and has all you need to know. Radio Shack stores also sell FCC License Preparation packets for Novice, Technician, and General Class licenses.

---

You are now ready to take your exam. You do not have to go to an imposing Federal office building in a big city to take the test, because these days the FCC has authorized ham volunteers to give all the exams. For a Novice license, the examiners can be any two ham operators with General or higher class licenses that are at least 18 years of age and are not related to you. And the Novice exam is free!

The Novice Class license allows you to use your HTX-100 transceiver between 28.1 MHz and 28.5 MHz. You can transmit CW (Morse Code) on any frequency, but you can only transmit voice on 10-meter band frequencies from 28.3 MHz to 28.5 MHz. Your HTX-100 can tune up to 29.6999 MHz, but these higher frequencies are reserved for higher-class licensees. Keep on practicing and learning, and soon you will have legal access to all the frequencies accessible with your transceiver. There is no rush, though. Your Novice license is good for ten years, and even then you can renew it indefinitely.

Eventually, you will want to get a higher class of amateur license, with more privileges. Exams for Technician, General, Advanced, and Extra Class licenses are given by three-member Volunteer Examiner Teams. Hundreds of exam sessions are held across the country every month, most on weekends. (You can take the Novice exam from a Volunteer Examiner Team, too, if it is more convenient.) When you are ready, you can get a schedule of exam opportunities in your area from the ARRL.

We have mentioned the ARRL several times. That is because the League is the national organization that represents amateur radio in the United States. The League has more than 150,000 members; most of them ham operators, but many are ham operators-to-be. Here is the address of ARRL Headquarters.

The American Radio Relay League  
225 Main Street  
Newington, CT 06111

The ARRL staff helped us prepare this section of the owner's manual, and they would be glad to hear from you if you need more information, or if you would like to join!

Amateur radio is a great hobby that has enriched the lives of millions of people the world over. Radio Shack takes pride in bringing to you the HTX-100 transceiver to enrich your life.

# ACCESSORIES PROVIDED

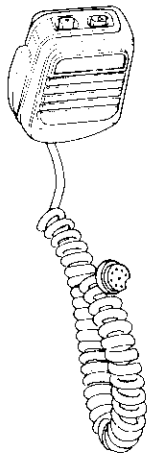

**Microphone**

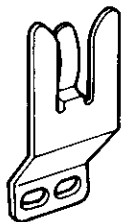

**Microphone Holder**



**Two Washers**



**Two Screws**

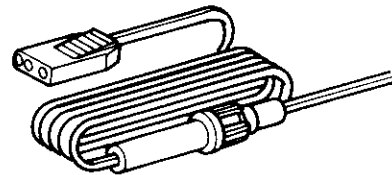

**Power Cord**

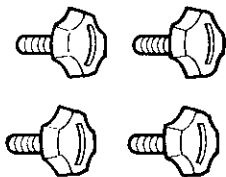

**Four Mounting Knobs**

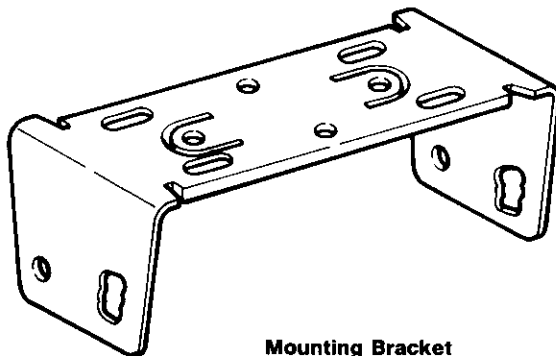

**Mounting Bracket**



**Four Lock Washers**



**Four Flat Washers**



**Four Screws**

# INSTALLING YOUR TRANSCEIVER

You can install your transceiver in your vehicle, boat, or home. You can even set up several places for your transceiver. To install your transceiver in several places, you need an extra power cord (Radio Shack Cat. No. 21-550) and a 6-amp slow-blow fuse (Cat. No. 270-1291).

Read the instructions carefully. If you are unsure of any connection, have a professional installer complete the installation.

## MOBILE INSTALLATION

### Mounting Your Transceiver

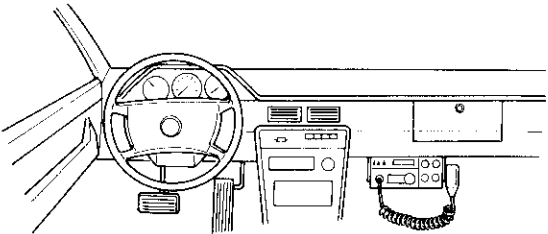
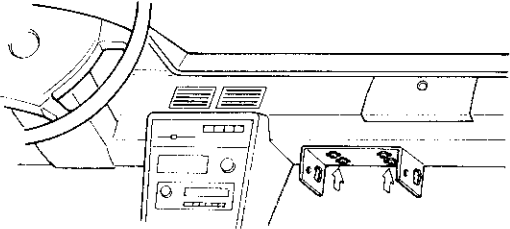
<b>1</b>	Select a location for your transceiver that is convenient and not in the way of the driver or passengers in the vehicle.	
<b>2</b>	Use the supplied mounting bracket as a template, and mark the locations of the four screw-holes on the mounting surface.	

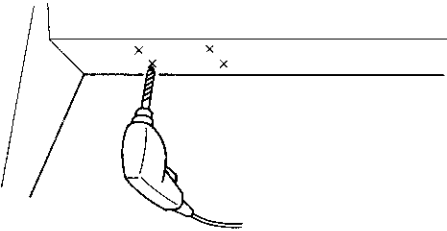
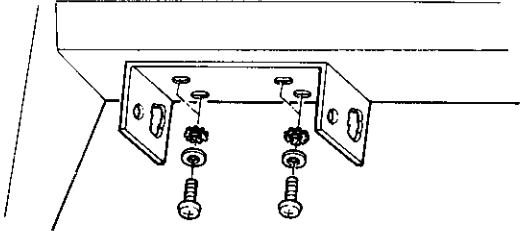
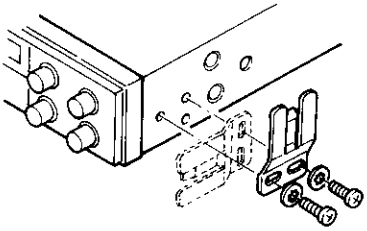

<b>3</b>	Drill $\frac{1}{16}$ -inch pilot holes for the supplied screws at the marked locations. Take care not to drill into or damage objects behind the mounting surface.	
<b>4</b>	Secure the bracket to the mounting location using the supplied self-threading screws, flat washers and lock-washers.	
<b>5</b>	Attach the microphone holder to either the left or right side of your transceiver, as shown, using the supplied screws and washers.	

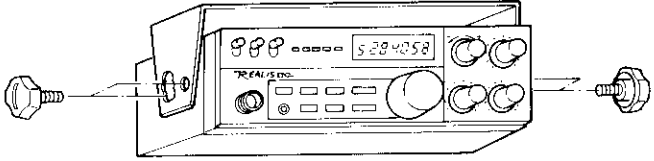
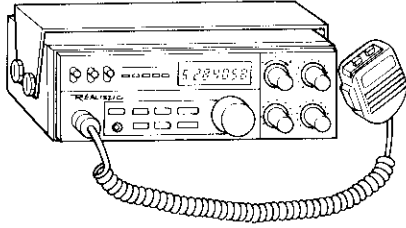
<b>6</b>	Attach your transceiver to the mounting bracket using the four mounting knobs.	 A line drawing of a rectangular transceiver unit. It is being mounted onto a metal bracket. Four screws are shown being inserted into the bracket, one on each side of the transceiver. The transceiver has a digital display showing '5284058', several control knobs, and a microphone jack on the front panel.
<b>7</b>	Plug the microphone into the microphone jack on the front of your transceiver and secure it with the threaded metal collar.	 A line drawing of the same transceiver unit. A microphone is plugged into the microphone jack on the front panel. The microphone is connected to the transceiver by a coiled cable. The microphone has a threaded metal collar at its base.

---

---

## Connecting a Mobile Antenna

Of course, before you connect an antenna to your transceiver, you must first select the appropriate antenna. Radio Shack stores sell several antennas suitable for use on the 10-meter band. These antennas are designed for citizen's band radio, but can be easily adjusted to work perfectly on the 10-meter band. Follow the instructions that come with the antenna to trim the element to the correct length.

If you do not buy the antenna from a Radio Shack store, you probably need to buy antenna cable for your antenna. We designed your transceiver to operate into a 50-ohm load. We recommend that you use RG-58/U cable to connect the antenna to your transceiver. This cable has the correct ratings for best performance.

<b>1</b>	Mount the antenna on a suitable location on your vehicle according to the antenna's instructions. For best performance, position the antenna as high as possible on your vehicle.
<b>2</b>	Route the antenna cable to the location of your transceiver. Be sure to avoid sharp edges or moving parts that might damage the cable. Also, do not route the cable next to power cables, other antenna cables, or through areas of extreme heat.
<b>3</b>	Screw the antenna cable's connector onto the ANT connector on the back of your transceiver.  If necessary, remove the transceiver from the bracket to access the connector.

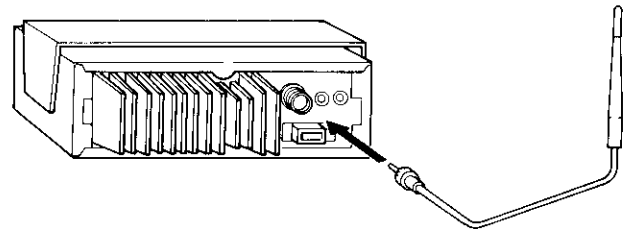



## Connecting to Power

We designed your transceiver to connect to a 12-volt, negative ground power system. This is the most common type of power system used in vehicles, but determine the type of power system your vehicle uses before you connect power. If you cannot determine the polarity of your vehicle

or are unsure, contact your dealer for information.

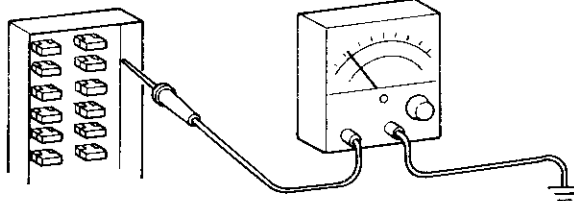
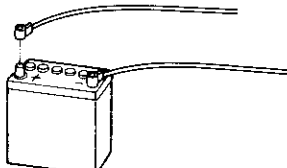
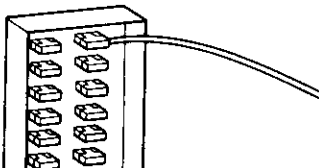
**Warning:** Do not connect power if you have not installed an antenna. Transmitting without an antenna attached damages your transceiver.

<b>1</b>	Use a voltmeter or test light to locate a point on the vehicle's fuse block that provides power only when the vehicle's ignition is in the ON or ACC position. Then, turn off the ignition and remove the fuse from that point on the fuse block. Turn on the ignition, and determine which side of the fuse now has voltage. This is the battery side of the fuse. Mark this point, and replace the fuse you removed.	
<b>2</b>	Disconnect the vehicle's positive (+) terminal cable. This prevents damage to your vehicle or your transceiver if you accidentally cross a wire.	
<b>3</b>	Connect the bare end of the red wire to the point you marked in Step 1.	

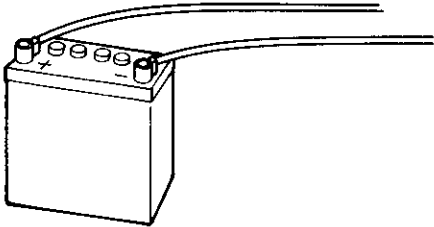
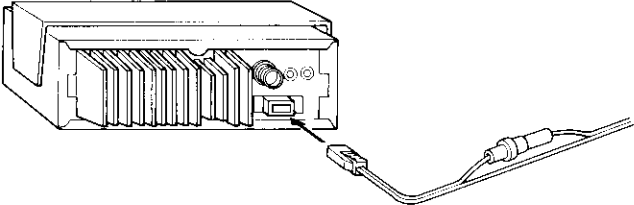
<p><b>4</b></p>	<p>Connect the bare end of the black wire to a metal chassis part.</p> <p><b>Note:</b> Modern vehicles have many non-metallic parts. If you connect the black wire to one of these parts, or if one of these parts insulate the black wire from the vehicle's main chassis, your transceiver does not work.</p>	 <p style="text-align: center;">Black</p>
<p><b>5</b></p>	<p>Reconnect the vehicle's positive terminal cable. Turn on the ignition and use a voltmeter or test light to confirm that +12V is supplied to the connector.</p>	
<p><b>6</b></p>	<p>Turn off the ignition, and plug the power cord's connector into the POWER jack on the back of your transceiver.</p> <p><b>Note:</b> The power cord's connector and the POWER jack are polarized, so the connector only plugs in one way.</p>	

---

---

## MARINE INSTALLATION

You can mount your transceiver in your boat, but be sure to protect it from spray and splash. Your transceiver is not waterproof and could be a serious hazard if you try to operate it when it is wet. Also, if salt water gets on or in your transceiver, the controls and connections will corrode.

### Mounting Your Transceiver

When selecting a place to mount your transceiver in a boat, keep in mind the following guidelines.

Select a location that:

- Is sturdy enough to support your transceiver.
- Is not exposed to spray or splash.
- Is close to the battery or fuse block.
- Allows you to route the power cord away from the engine compartment and walkways.
- Is as close to the antenna as possible. See "Connecting to a Marine Antenna" for further considerations.
- Is shielded from direct sunlight.
- Is several feet away from the compass.

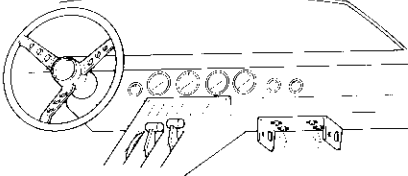
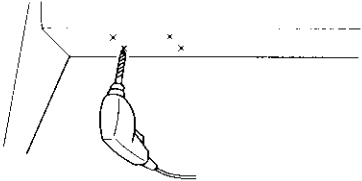
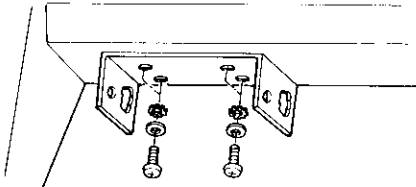
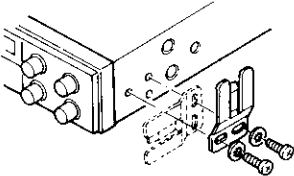
<p><b>1</b></p>	<p>Use the supplied mounting bracket as a template, and mark the locations of the four screw holes on the mounting surface.</p>	
<p><b>2</b></p>	<p>Drill <math>\frac{1}{16}</math>-inch pilot holes for the supplied screws at the marked locations. Take care not to drill into or damage objects behind the mounting surface.</p>	
<p><b>3</b></p>	<p>Secure the bracket to the mounting location using the supplied self-threading screws, flat washers and lock-washers.</p>	
<p><b>4</b></p>	<p>Attach the microphone holder to either the left or right side of your transceiver, as shown, using the supplied screws and washers.</p>	

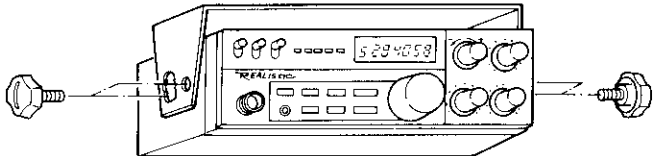
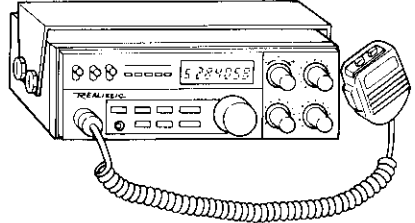
<b>5</b>	Attach your transceiver to the mounting bracket using the four mounting knobs.	 A line drawing of a rectangular transceiver mounted on a metal bracket. Four screws are shown passing through the bracket into the transceiver's chassis, securing it. The transceiver has a digital display showing '5 28405.8' and various control knobs and buttons.
<b>6</b>	Plug the microphone into the microphone jack on the front of your transceiver and secure it with the threaded metal collar.	 A line drawing of the same transceiver. A microphone with a coiled cord is plugged into the microphone jack on the left side of the front panel. A threaded metal collar is shown around the microphone's base, secured to the jack.



---

## Connecting a Marine Antenna

See “Connecting a Mobile Antenna” for information on antenna selection. An antenna mounted in a boat requires a ground that can be either a metal hull or a ground made of tin-foil or copper sheeting. This ground should cover an

area of 12 square feet (1 square meter) or more and connect to the outer shield of your antenna cable. Your transceiver should also have an adequate ground.

<b>1</b>	Mount the antenna on a suitable location on your boat according to the antenna’s instructions. For best performance, position the antenna as high as possible on your vehicle.
<b>2</b>	Route the antenna cable from the antenna to the location of your transceiver. Be sure to avoid sharp edges or moving parts that might damage the cable. Also, do not route the cable next to power cables, other antenna cables, or through areas of extreme heat.
<b>3</b>	Screw the antenna cable’s connector onto the ANT connector on the back of your transceiver.

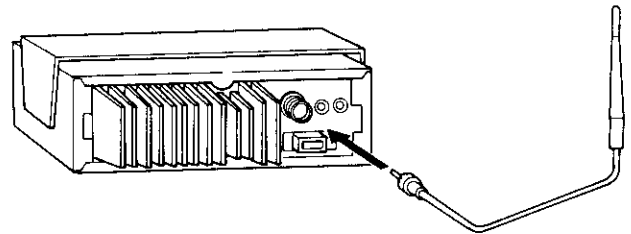

## Connecting to Power

**Warning:** Do not connect power if you have not installed an antenna. Transmitting without an antenna attached damages the transceiver.

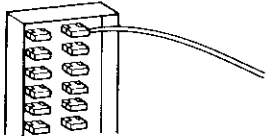
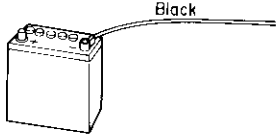
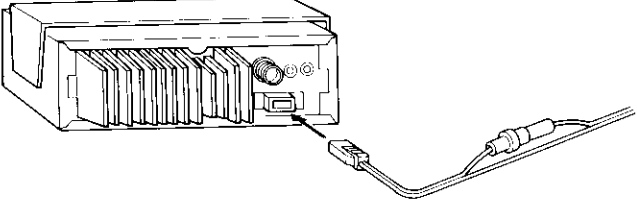
<b>1</b>	Determine where you are going to connect the power cable. If your boat has a fuse block, see Step 1 of "Connecting to Power" under "Mobile Installation." If your boat does not have a fuse block, you will connect the power cable directly to the positive (+) terminal on the battery.	
<b>2</b>	Connect the bare end of the red wire to the point you determined in Step 1.	
<b>3</b>	Connect the bare end of the black wire to an electrical ground, such as the negative (-) terminal of the battery.	
<b>4</b>	Plug the power cord's connector into the POWER jack on the back of your transceiver. <b>Note:</b> The power cord's connector and the POWER jack are polarized, so the connector plugs in only one way.	

## FIXED INSTALLATION

When you are installing your transceiver at a fixed location, positioning is not critical. Place it where it is easy to operate, and where it is not in any danger of being dropped.

### Connecting a Fixed Antenna

<b>1</b>	Select an outdoor antenna that is designed for the 10-meter band or that can be tuned to the 10-meter band.
<b>2</b>	Install the antenna according to its instructions.
<b>3</b>	Route the antenna cable to the location of your transceiver.
<b>4</b>	Screw the antenna cable's connector onto the ANT connector on the back of your transceiver.

### WARNING WARNING WARNING

When you are installing or removing a fixed station antenna, use extreme caution. If the antenna starts to fall, let it go! It could contact overhead power lines. **If the antenna is in contact with the power line, touching it could kill you!** Call the power company and have them remove the antenna. Do not attempt to remove the antenna yourself.

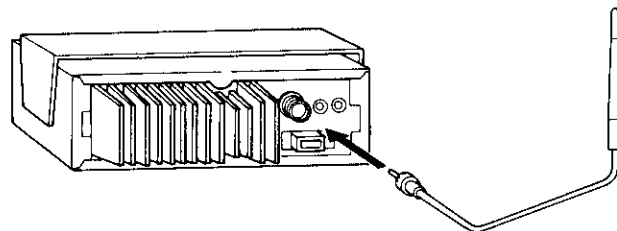

## Connecting to Power

When you use your transceiver at a fixed location, you must have an adequate power supply. Select a power supply that provides a regulated 12-14 volts and that can supply at least 6 amps.

**Note:** Make all power connections with the power supply turned off.

**Warning:** Do not apply power to the transceiver if you have not connected an antenna. Transmitting without an antenna attached damages your transceiver.

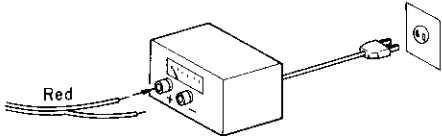
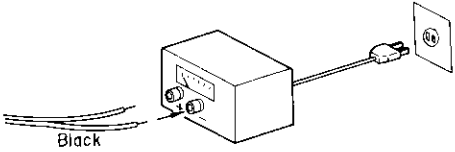
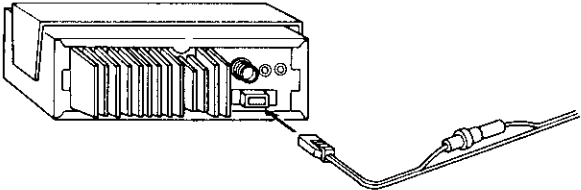
<b>1</b>	Connect the bare end of the red wire to your power supply's positive (+) terminal.	
<b>2</b>	Connect the bare end of the black wire to your power supply's negative (-) terminal.	
<b>3</b>	Plug the power cord's connector into the POWER jack on the back of your transceiver. <b>Note:</b> The power cord's connector and the POWER jack are polarized, so the connector plugs in only one way.	

## Attaching the Microphone

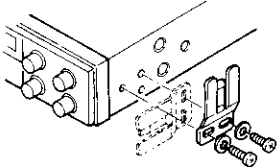
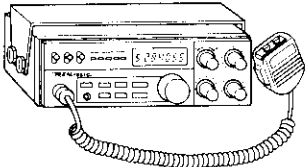
<b>1</b>	Attach the microphone holder to the right or left side of your transceiver using the supplied screws and washers.	
<b>2</b>	Plug the microphone cord's connector into the MICROPHONE jack on the front of your transceiver and secure it with the threaded metal collar.	

## CONNECTING AN EXTERNAL SPEAKER

In a noisy area, an external speaker such as Radio Shack's Cat. No. 21-549, positioned in the right place, might provide more comfortable listening. Simply plug the speaker cable's 1/8-inch plug into the EXT.SP. jack on the back of your transceiver. This disconnects the internal speaker.

## CONNECTING HEADPHONES

For private listening, plug a set of mono headphones such as Radio Shack's Cat. No. 20-210 into the phones jack. This automatically disconnects the speaker.

---

---

## CONNECTING A CODE KEY

You connect a code key if you plan to transmit CW with your transceiver.

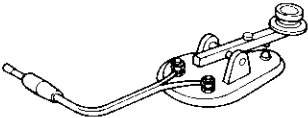
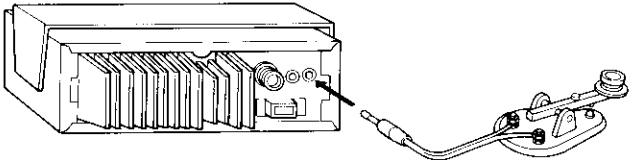
<b>1</b>	Attach a shielded cable with a $\frac{1}{8}$ inch (mini) plug (not provided) to the code key.	
<b>2</b>	Insert the code key's plug into the KEY jack on the back of your transceiver.	

# OPERATION

## GETTING STARTED

This section describes how to turn on and set the operating controls of your transceiver the first time. Go ahead and follow these instructions, then read the following sections for more information on what each switch does.

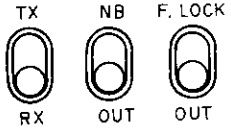
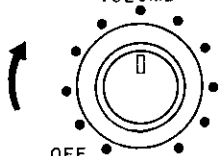
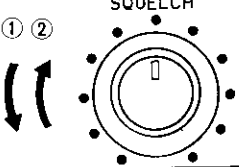
<b>1</b>	Set all the switches as shown.	 <p>TX NB F. LOCK RX OUT OUT</p>
<b>2</b>	Turn the VOLUME control clockwise to turn on your transceiver. Set the volume at about the midpoint.	 <p>VOLUME OFF</p>
<b>3</b>	Adjust the SQUELCH control counterclockwise until you hear a hissing sound. Then, slowly rotate the control clockwise until the hissing stops.	 <p>SQUELCH ① ②</p>

Your transceiver is now ready to tune-in to the action.

## TUNING YOUR TRANSCEIVER

### Setting the Frequency Step

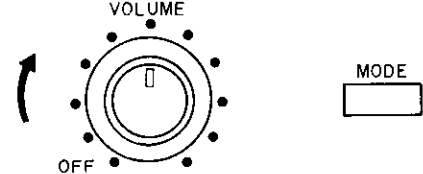
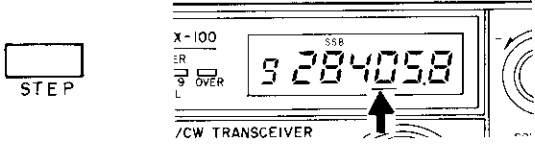
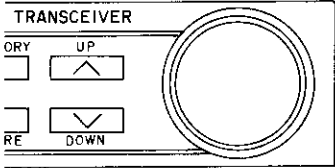
<b>1</b>	Turn on your transceiver and select the SSB or CW mode by pressing MODE. SSB or CW appears on the display to indicate the mode.	 A diagram showing a circular volume knob with a vertical slider in the center. The knob has several small dots around its perimeter. An arrow on the left indicates a counter-clockwise rotation. The word "VOLUME" is printed above the knob, and "OFF" is printed below it. To the right of the knob is a rectangular button labeled "MODE".
<b>2</b>	Press [STEP]. The underline moves to the next digit. This underline shows the digit that increments or decrements when you use the tuning knob or the UP and DOWN buttons. Press [STEP] a few more times. Each time you press [STEP] the underline moves.	 A diagram showing a rectangular button labeled "STEP" on the left. To its right is a digital display panel. The display shows "X-100" at the top left, "SSB" at the top right, and "9 284058" in the center. Below the display are labels "ER", "OVER", and "L". Below the display panel is the text "/CW TRANSCEIVER". An arrow points to the underline under the digit "4" in the frequency display.
<b>3</b>	Tune to a frequency using the tuning knob (see "Using the Tuning Control") or the UP and DOWN buttons (see "Using the UP and DOWN Buttons").	 A diagram of a control panel labeled "TRANSCEIVER". It features a large circular tuning knob on the right. To the left of the knob are two buttons: the top one is labeled "UP" with an upward-pointing arrow, and the bottom one is labeled "DOWN" with a downward-pointing arrow. Below these buttons are the labels "ORY" and "RE".

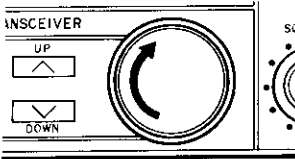
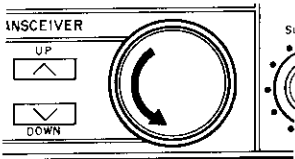

## Using the Tuning Control

<b>1</b>	Press [STEP] so that the underline is under the digit by which you want to increment or decrement.	
<b>2</b>	Turn the tuning control clockwise to increase the frequency.	
<b>3</b>	Turn the tuning control counterclockwise to decrease the frequency.	

**Hint:** If you are moving to a distant frequency, start with a large step. As you get closer reduce the stepping frequency. For a very large jump, see “Using the 500K Button.”

**Note:** When you reach either end of the frequency range, the transceiver “wraps around” to the other end of the range. So, if the frequency is 29.6999 and you increase the frequency by .001, the new frequency is 28.0009.

---

## Using the UP and DOWN Buttons

Your transceiver has two sets of UP and DOWN buttons. One set is on the front of the transceiver and the other set is on your microphone. Each set operates in the same manner, so follow these instructions to use either.

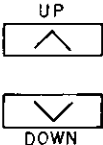
<b>1</b>	Press [STEP] to set the stepping frequency.	 A rectangular button with the word "STEP" centered below it.
<b>2</b>	Press UP to go up one frequency step or DOWN to go down one frequency step. If you hold down either button longer than $\frac{1}{2}$ second, your transceiver steps rapidly through the frequencies.	 Two rectangular buttons. The top one has "UP" above an upward-pointing chevron symbol. The bottom one has a downward-pointing chevron symbol above "DOWN".

**Scanning Hint:** If you are randomly scanning, trying to find someone that is transmitting, press and hold either button while watching the RF POWER/SIGNAL meter. When you pass the active frequency, the indicators come on briefly. Stop scanning, and manually step to the active frequency.

### Fine-Tuning with RIT

RIT means Receiver Incremental Tuning. This is just a fancy way of saying fine-tuning. The one difference in this control, is that this only fine-tunes the receiver. When you transmit, your transceiver uses the exact frequency displayed. Use this control if someone else's transmitter is a little off-frequency. Tune up or down with this control until the incoming signal sounds the best.

---

---

## Using the 500K Button

The [500K] button is handy if you need to get rapidly to the other end of the band from where you are currently tuned. Pressing [500K] causes the frequency to increase by .5 MHz (500 kHz).

## USING THE RF GAIN CONTROL

When you have established a conversation, or if you are monitoring a conversation, you can increase or decrease the level of the signal received by your transceiver. If you are monitoring a nearby high-power unit, the signal strength could cause the signal to distort. Turn the RF GAIN control counterclockwise to decrease the amount of RF gain and make the signal more "readable." If you are monitoring a low-powered, distant unit, turn the RF GAIN control clockwise to increase the amount of RF gain and boost the incoming signal.

## USING F.LOCK/OUT

When the F.LOCK/OUT switch is set to the F.LOCK position, you cannot change the tuned frequency. Use this to prevent accidentally changing the frequency when you have tuned to an interesting or important broadcast. Set the F.LOCK/OUT switch to OUT to allow you to change frequencies.

## USING THE NB/OUT SWITCH

The NB/OUT switch allows you to turn on and off the noise-blanker circuit. The noise-blanker circuit greatly reduces or eliminates noise generated by automotive ignition, electrical motors, or other devices that might generate spurious RF noise. Normally, leave the NB/OUT switch set to NB.

## USING THE RF POWER/SIGNAL LED INDICATORS

Five LEDs function as an RF Power meter to indicate the relative transmission output power in the transmission mode, and as a signal strength meter to indicate the relative strength of the received signal in the reception mode.

---

## **TRANSMITTING**

Remember, before you can transmit, you must have a FCC Amateur Radio Operator's License. Also, be sure you know your transmit privileges.

### **Transmission Power**

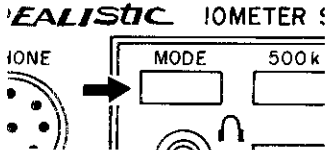
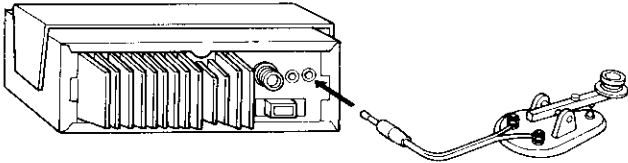
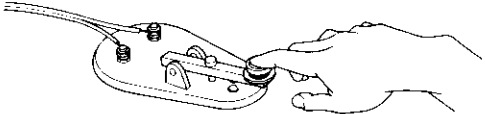

Your transceiver has two power output levels — 5 watts and 25 watts. Regulations require that you use the minimum power necessary to maintain reliable communications. As a rule, for local communications, pull out the RF GAIN control. This switches your transceiver to low power (ham operators call this QRP — the Q-signal for reduced power). If the other party has trouble receiving your signal, push in the RF GAIN control to switch to 25W.

## Transmitting CW (Morse Code)

<b>1</b>	Select a frequency.	 A digital display showing the frequency 928405.8. Above the numbers, the letters "CW" are displayed.
<b>2</b>	Press [MODE] so that <b>CW</b> appears in the display.	 A control panel for a "REALISTIC IOMETER". It features a "MODE" button with an arrow pointing to it from the left. To the right of the "MODE" button is a "500k" control. There are also some indicator lights and a speaker icon.
<b>3</b>	Plug in the code key.	 A line drawing of a transceiver with a code key plugged into its side. The code key is a handheld device with a spring-loaded contact.
<b>4</b>	Start keying. Your transceiver automatically begins transmitting, and generates a CW tone each time you operate the key. Your transceiver switches to receive one second after your last key press.	 A line drawing showing a hand operating the code key. The hand is shown from the side, with the index finger pressing down on the key's contact.

**Note:** See "Using TX/RX" for information on transmitting continuously.

## Transmitting SSB (Voice)

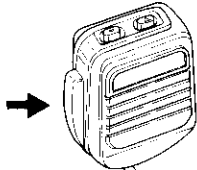
<b>1</b>	Select a frequency higher than 28.3000 MHz.	
<b>2</b>	Press [MODE] so that <b>SSB</b> appears in the display.	
<b>3</b>	Press the push-to-talk button on the microphone to talk, and release the button to listen.	



## Using the TX/RX Switch

In most situations, just leave the TX/RX switch set to RX. If, however, you are sending a long CW message, it might be easier to send with the transceiver constantly in the transmit mode. To do this, simply set the TX/RX switch to TX. To listen for a reply, you must set the switch back to RX.

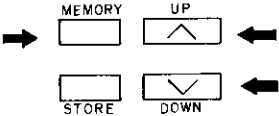
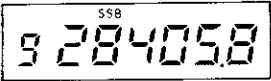

## MEMORY CHANNELS

Your transceiver has 10 memory channels you can use to store and recall important frequencies.

### Storing a Frequency in Memory

<b>1</b>	Press [MEMORY], then UP or DOWN until the desired memory number (0-9) appears in the display.	
<b>2</b>	Select a frequency to store using the tuning control.	
<b>3</b>	Select a transmit mode (CW or SSB).	
<b>4</b>	Press [STORE] to store the frequency and mode in the memory.	

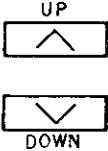
## Recalling a Frequency from Memory

<b>1</b>	Press [MEMORY]. <b>MEMO</b> appears in the display.	 <p>A rectangular button with the word "MEMORY" centered above it.</p>
<b>2</b>	Press UP or DOWN until the desired memory appears.  Your transceiver is set to the displayed frequency.	 <p>Two rectangular buttons. The top button has "UP" centered above it and an upward-pointing chevron symbol inside. The bottom button has "DOWN" centered below it and a downward-pointing chevron symbol inside.</p>
<b>3</b>	To return to normal tuning, press [MEMORY].	 <p>A rectangular button with the word "MEMORY" centered above it.</p>



# ADVANCED INFORMATION

## DIGITAL COMMUNICATIONS

Several exciting operating modes are now available to the novice or technician class amateur radio operator. These are packet radio and several forms of RTTY (radio teletype). These modes let you send information from your computer to other computers using your ham radio. For more in-depth information concerning interfacing your computer to the ham world, we recommend you read *Digital Communications with Amateur Radio*, available at your local Radio Shack store. The following information is to help you use digital devices with your HTX-100.

Receive-to-Transmit Turnaround Time . . . . . 40 ms

## MICROPHONE JACK PIN FUNCTIONS

- 1 — Microphone Input
- 2 — Push-To-Talk\*
- 3 — Channel Down\*
- 4 — Channel Up\*
- 5 — 8 Volts (Power Indicator)
- 6 — Audio Out
- 7 — Microphone Ground
- 8 — Ground

\*Connect to Ground for function.

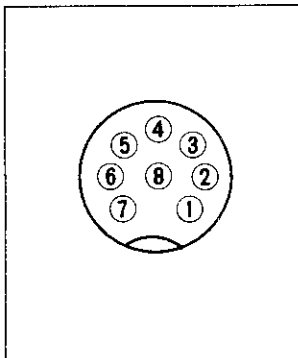

## 10-METER BAND PLAN

The following chart gives the latest information on the "gentleman's agreement" that ARRL members follow when using the 10-meter band.

Frequency	Operating Mode	Note
28.000 - 28.070	CW	
28.070 - 28.150	RTTY	
28.150 - 28.190	CW	
28.100 - 28.200	CW	New Beacon Band*
28.200 - 28.300	CW	Old Beacon Band* Until 1990
28.300 - 29.300	Phone	
29.300 - 29.510	Satellites	
29.510 - 29.590	Repeater inputs	
29.600	FM simplex calling frequency	
29.610 - 29.700	Repeater inputs	

\*Beacon bands are reserved for special stations. Do not transmit in these bands.

## A WORD ABOUT NOISE

---

Your vehicle generates electrical noise that can cause interference on your transceiver. Since the receiver section of your transceiver is very sensitive, it picks up even the smallest noise signals and amplifies them. Any noise that you hear from the transceiver is almost totally from external sources. The receiver itself is exceptionally quiet. If the noise is continuous and fairly loud, it cannot be totally eliminated by the automatic noise limiter circuit or the noise blanking circuit. You must solve the problem at its source. To find out if the noise is from your ignition system, try this simple test. Turn off your ignition switch, then set it to ACC (accessory). This turns off the ignition, but supplies power to the transceiver. The noise probably disappears, suggesting that the source of the noise is your vehicle's ignition or other electrical system.

You can identify ignition noise because it varies with the speed of the engine. Ignition noise consists of a series of popping sounds. There are many things that can be done to reduce this type of noise.

- Use only the radio suppression-type high-voltage ignition wire (spark-plug and coil cables). Most new cars come equipped with this type of wire.
- Inspect the ignition wire and all connections. Old ignition wire can develop leaks, resulting in noise.
- If the noise persists, replace the spark plugs with types that have built-in suppressor resistors. Be sure to use the correct type of spark plug for your vehicle.

Other sources of noise are:

- Generator/alternator
- Voltage regulator
- Gauges
- Static Discharge

You can efficiently reduce or eliminate most of these noises by installing bypass capacitors at the devices various voltage points. Check your local Radio Shack store for a selection of noise reduction accessories.

## CARE AND MAINTENANCE

---

Your HTX-100 is an example of superior design and craftsmanship. The following suggestions will help you care for your transceiver so you can enjoy it for years.



Keep the transceiver dry. If it gets wet, wipe it dry immediately. Liquids contain minerals that can corrode the electronic circuits.



Handle the transceiver gently and carefully. Dropping it can damage circuit boards and cases and can cause the unit to work improperly.



Keep the transceiver away from dust and dirt, which can cause premature wear of parts.



Wipe the transceiver with a dampened cloth occasionally to keep it looking new. Do not use harsh chemicals, cleaning solvents, or strong detergents to clean the transceiver.

Modifying or tampering with the transceiver's internal components could result in illegal operation. If your transceiver is not operating properly, take it to your local Radio Shack store. Our personnel can help you and arrange for service if needed.

## IF YOU HAVE PROBLEMS

We hope you do not have any problems with your transceiver, but if you do, try these suggestions.

1. If you have problems receiving:

- Be sure VOLUME is set to a high enough level.
- Be sure SQUELCH is not set too high.
- Confirm the antenna is the right type, and is properly connected.
- Be sure the TX/RX switch is set to RX.

2. If you have problems transmitting:

- Be sure the antenna cable is the right type, and is properly connected.
- Be sure you fully press the push-to-talk switch.
- Be sure the microphone cable is securely pressed into the MICROPHONE jack.

3. If the transceiver does not work at all:

- Confirm the fuse is not blown. If it is, replace it with a 6-amp slow-blow fuse.
- Be sure the power cable is properly connected.

## RESETTING YOUR TRANSCEIVER

If your transceiver is subjected to a transient static charge, the display might lock up. If this occurs, follow this procedure to reset your transceiver.

This procedure clears any frequencies you have stored into channels.

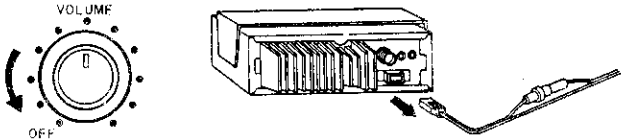
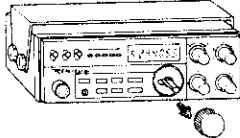
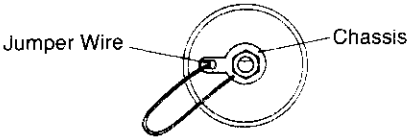
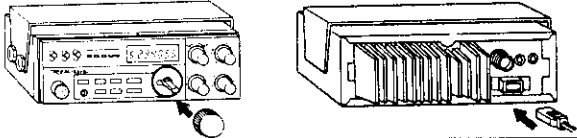
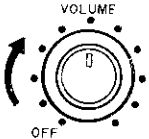
<b>1</b>	Turn off power and remove the power cord.	 <p>The diagram shows a close-up of a volume knob with 'VOLUME' at the top and 'OFF' at the bottom. A curved arrow indicates the knob is being turned to the 'OFF' position. To the right, a transceiver is shown with a power cord being unplugged from its rear panel.</p>
<b>2</b>	Remove the tuning control knob.	 <p>The diagram shows the front panel of a transceiver with a tuning control knob being lifted off its base.</p>
<b>3</b>	Use a small metal probe, such as a paper clip, to short the exposed jumper wire to the transceiver's chassis.	 <p>The diagram shows a circular terminal with a small metal probe (a paper clip) touching it. A label 'Jumper Wire' points to the probe, and another label 'Chassis' points to the terminal.</p>
<b>4</b>	Replace the tuning control knob and connect the power cord.	 <p>The diagram shows the front panel of the transceiver with the tuning control knob being replaced. To the right, the transceiver is shown with the power cord being plugged back into its rear panel.</p>
<b>5</b>	Turn on the transceiver and confirm the display works properly.	 <p>The diagram shows a close-up of the volume knob with 'VOLUME' at the top and 'OFF' at the bottom. A curved arrow indicates the knob is being turned to a position above the 'OFF' mark.</p>

# SPECIFICATIONS

---

## GENERAL

Frequency Range . . . . . 28.0000-29.6999 MHz  
Speaker . . . . . 8 $\Omega$ , 5W  
Operating Modes . . . . . SSB, CW  
Display . . . . . Backlit LCD  
Display Items . . . . . Frequency, Memory Mode, TX  
Size . . . . . 2 7/16" x 7 9/32" x 7 7/8" (HWD)  
Weight . . . . . 4 lbs, 3 oz  
Power Source . . . . . 13.8V DC +15/-20%, Negative Ground

## TRANSMITTER

Frequency Stability . . . . .  $\pm$ 300 Hz Nominal, at 25°C,  
5 Minutes after Power on  
RF Output Power . . . . . CW 25W Nominal (QRP5W)  
SSB 25W PEP Nominal (QRP5WPEP)  
Spurious Harmonic Emissions . . . . . -50 dB Nominal,  
CW, SSB Modes  
Carrier Suppression . . . . . -55 dB Nominal, SSB Mode  
Unwanted Sideband  
Suppression . . . . . -50 dB Nominal, SSB Mode  
Power Consumption . . . . . SSB 0.8A Nominal, No Modulation  
CW 0.8A Nominal, Break Period  
Microphone Input . . . . . 1 mV Nominal  
for 10W PEP output, SSB

## RECEIVER

Sensitivity for 10 dB S/N . . . . . CW/SSB 0.25  $\mu$ V Nominal  
Adjacent Channel Selectivity . . . . . 70 dB Nominal  
(10 kHz Spacing)  
Max. Audio Output . . . . . 3W Nominal  
RF Gain Range . . . . . 55 dB Nominal  
RIT Range . . . . .  $\pm$ 1.5 kHz Nominal  
"S" Meter Sensitivity at S-9 . . . . . 100  $\mu$ V Nominal  
Image Rejection Ratio . . . . . 65 dB Nominal  
Power Consumption, No Signal . . . . . 500 mA Nominal  
Power Consumption, Max Audio . . . . . 1000 mA Nominal

# SCHEMATIC DIAGRAM

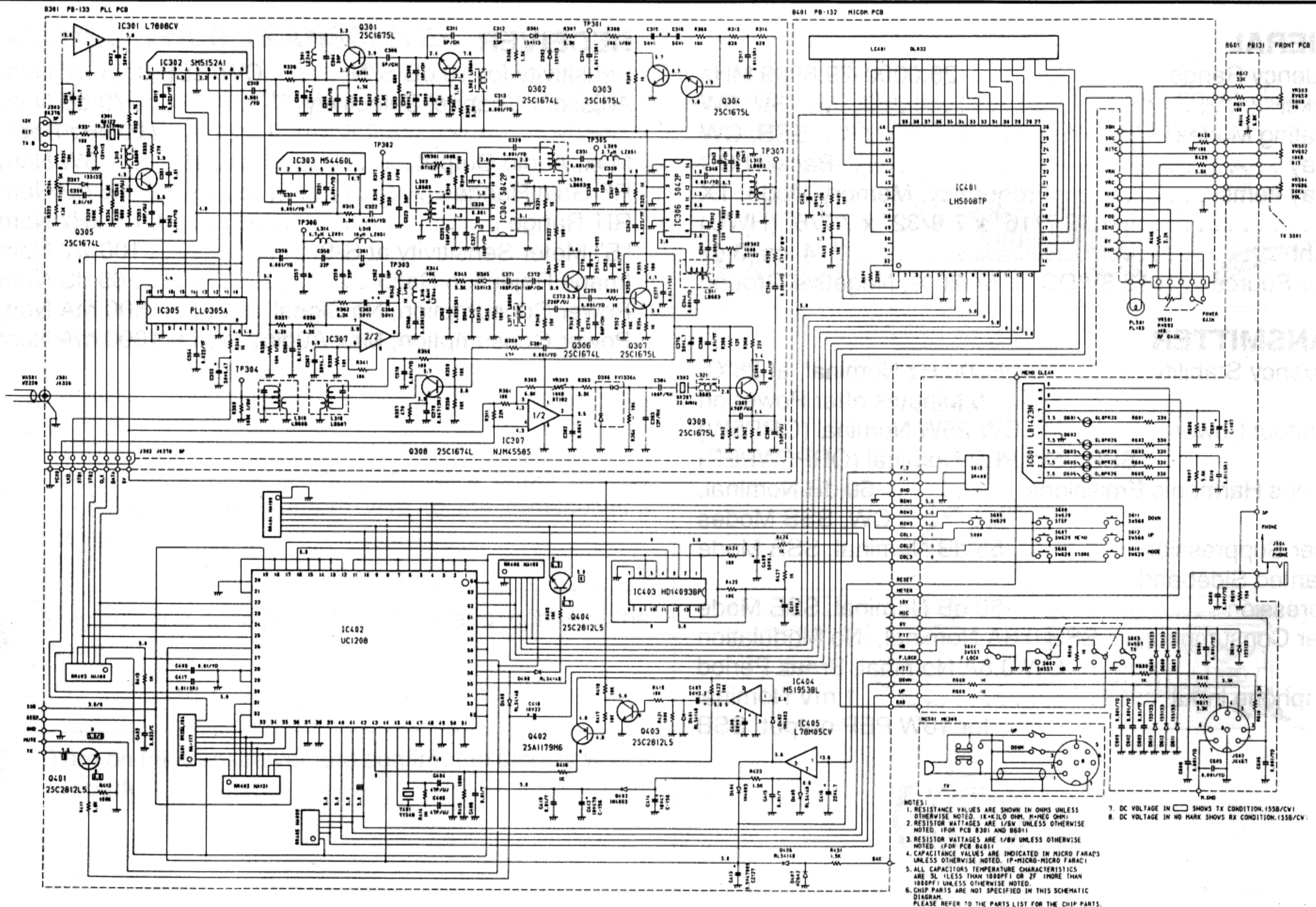



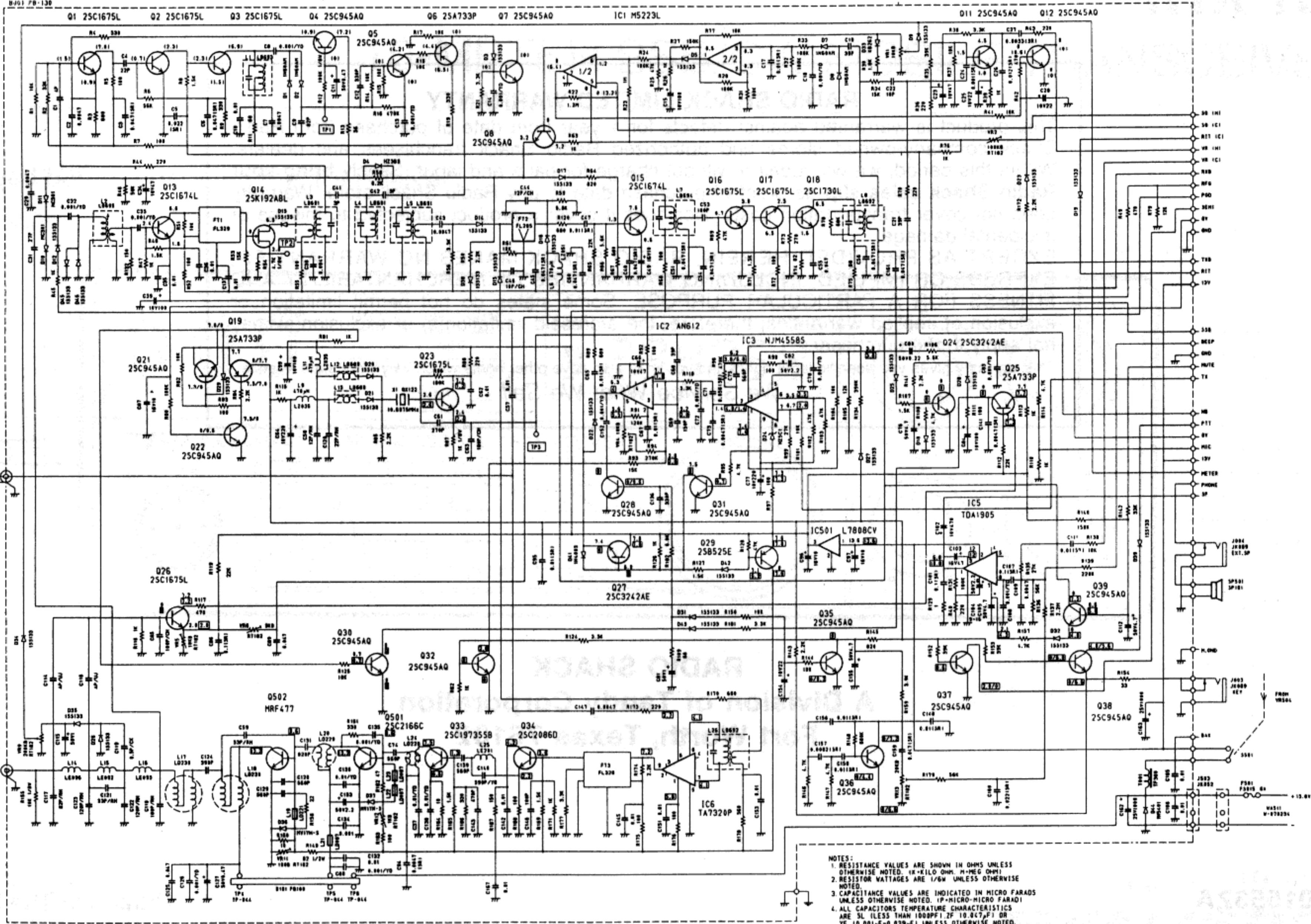

- NOTES:
1. RESISTANCE VALUES ARE SHOWN IN OHMS UNLESS OTHERWISE NOTED. 1K=KILO OHM, M=MEG OHM
  2. RESISTOR VATTAGES ARE 1/6W UNLESS OTHERWISE NOTED
  3. CAPACITANCE VALUES ARE INDICATED IN MICRO FARADS UNLESS OTHERWISE NOTED. (P=PICO-MICRO FARAD)
  4. ALL CAPACITORS TEMPERATURE CHARACTERISTICS ARE 5L (LESS THAN 100PPM) 2F TO 847P3 OR YF (0.001P-0.039P) UNLESS OTHERWISE NOTED.
  5. DC VOLTAGE IN  $\square$  SHOWS TX CONDITION. (558/CW)
  6. DC VOLTAGE IN  $\square$  SHOWS RX CONDITION. (558/CW)
  7. DC VOLTAGE IN  $\square$  SHOWS RX CONDITION UNDER OPERATION OF EACH FUNCTION.

### **RADIO SHACK LIMITED WARRANTY**

This product is warranted against defects for 1 year from date of purchase from Radio Shack company-owned stores and authorized Radio Shack franchisees and dealers. Within this period, we will repair it without charge for parts and labor. Simply **bring your Radio Shack sales slip** as proof of purchase date to any Radio Shack store. Warranty does not cover transportation costs. Nor does it cover a product subjected to misuse or accidental damage.

EXCEPT AS PROVIDED HEREIN, RADIO SHACK MAKES NO WARRANTIES, EXPRESS OR IMPLIED, INCLUDING WARRANTIES OF MERCHANTABILITY AND FITNESS FOR A PARTICULAR PURPOSE. Some states do not permit limitation or exclusion of implied warranties; therefore, the aforesaid limitation(s) or exclusion(s) may not apply to the purchaser.

This warranty gives you specific legal rights and you may also have other rights which vary from state to state.

*We Service What We Sell*

**RADIO SHACK**  
**A Division of Tandy Corporation**  
**Fort Worth, Texas 76102**

**10A8**  
**UTRS01553ZA**

Printed in The Philippines