

OWNER'S MANUAL

HTX-404

440 MHz (70 CM) Amateur UHF FM Transceiver

Please read before using this equipment.

RADIO SHACK LIMITED WARRANTY

This product is warranted against defects for 1 year from date of purchase from Radio Shack company-owned stores and authorized Radio Shack franchisees and dealers. Within this period, we will repair it without charge for parts and labor. Simply **bring your Radio Shack sales slip as proof of purchase date** to any Radio Shack store. Warranty does not cover transportation costs. Nor does it cover a product subjected to misuse or accidental damage.

EXCEPT AS PROVIDED HEREIN, RADIO SHACK MAKES NO WARRANTIES, EXPRESS OR IMPLIED, INCLUDING WARRANTIES OF MERCHANTABILITY AND FITNESS FOR A PARTICULAR PURPOSE.

Some states do not permit limitation or exclusion of implied warranties; therefore, the aforesaid limitation(s) or exclusion(s) may not apply to the purchaser.

This warranty gives you specific legal rights and you may also have other rights which vary from state to state.

We Service What We Sell

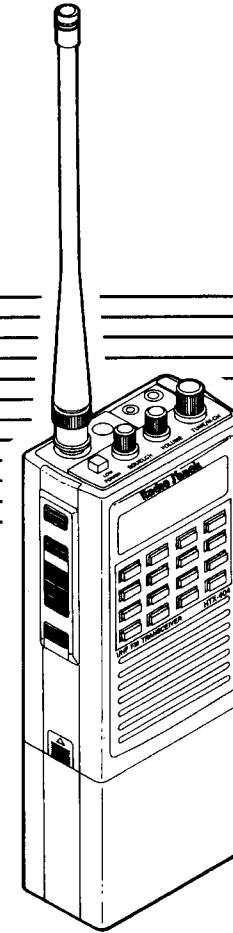

Radio Shack
A Division of Tandy Corporation
Fort Worth, Texas 76102

936732AB
Printed in Korea

Cat. No. 19-1140

Radio Shack®

Features

The Radio Shack HTX-404 440 MHz (70 cm) Amateur UHF FM Transceiver offers both the newly-licensed Tech and the experienced amateur the most advanced features presented in a handheld transceiver. Read this entire manual to learn about all of your HTX-404's capabilities.

Narrow Front End — rejects intermodulation interference from strong signal sources.

True FM Modulation — provides a more natural-sounding signal, with high clarity and better performance on packet systems.

16 Frequency Memories — includes one calling-frequency memory, three priority-frequency memories, and 12 standard memories.

Tone Coded Transmit and Decode (CTCSS) — includes the subaudible tones required by some repeaters, and also lets you set a subaudible tone that your HTX-404 must receive to open squelch.

Touch-Tone Page — lets you set a sequence of up to nine touch tones your HTX-404 must receive to sound an alert tone and open squelch.

Programmable Power Saver — extends battery life by setting the receiver to standby when there are no transmissions.

Nine DTMF Memory Sequences — let you store nine touch-tone sequences of up to 15 digits each so you can quickly transmit the sequences you commonly use to activate repeaters, autopatches, or other stations equipped with touch-tone page.

Multi-Function Scanning — includes standard memory, priority-frequency memory, and frequency range scanning, and automatically resumes scanning when the carrier drops, resumes scanning after 10 seconds, or stops scanning when it detects a carrier.

Programmable Frequency Step — lets you set the frequency step for tuning or scanning to 5, 10, 15, 20, 25, 50, or 100 kHz.

Note: You must have a Technician Class or higher Amateur Radio Operator's License and a call sign issued by the FCC to legally transmit. Transmitting without a license carries heavy penalties. Getting a license is easier than ever. See "Introduction to Amateur Radio" for more information

© 1993 Tandy Corporation.
All Rights Reserved.

Radio Shack is a registered trademark used by Tandy Corporation.

Contents

Manual Conventions	5
Introduction to Amateur Radio	6
Preparation	8
Power Sources	8
Operating from the Rechargeable Power Pack	8
Using Alkaline Batteries	9
Operating from Vehicle Battery Power	10
Operating from AC Power	11
Backup Battery	13
Connecting the Antenna	14
Activating Additional Frequencies	14
Attaching the Belt Clip	15
Attaching the Hand Strap	15
Using an External Microphone	16
Using an External Speaker	16
Using the HTX-404 with Packet Radio	17
Resetting the HTX-404	17
Using the Light	17
Basic Operation	18
Setting Squelch and Volume	18
Selecting a Frequency	18
Tuning Using Direct Entry	18
Tuning Using the Tune Control	19
Scanning for Active Frequencies	19
Scanning for a Vacant Frequency	19
Receiving Transmissions	20
Transmitting	20
Locking the Keypad	22
Setting the Key Entry Beep	22
Reversing the Offset	22
Using Memory Channels	23
Changing Memory Options	23
Using the Calling-Frequency Memory	24
Using the Priority-Frequency Memories	25
Using the Standard Memories	26
Clearing Memories	26
Moving a Memory Channel to the Manual Mode	27
Reviewing Programmed Options	27

Manual Conventions

Advanced Operation	28
Configuration Menu	28
Duplex Separation Default	29
Tone-Coded Squelch (CTCSS)	30
Scan Options	31
Frequency Step Rate	31
Scan Resume Condition	31
Scan Delay Duration	32
Scan Limits	32
Vacant Scan Direction	32
Power-Saving Feature	33
Preventing Transmissions	33
Limiting Transmission Duration	34
Setting the Priority Scan Time	34
Using Touch-Tone Features	35
Manually Sending Touch Tones	35
Storing a DTMF Memory Sequence	35
Transmitting a DTMF Memory Sequence	36
Using DTMF Squelch for Paging	36
Automatically Sending a DTMF Reply	36
Error Codes	37
Er1: Internal RAM Error	37
Er2: PLL Unlock Error	37
Care and Maintenance	38
Specifications	39
General	39
Receiver	39
Transmitter	40
Digital Schematic	41
RF Schematic	42
Key Index	43

For your important records, we recommend you record your HTX-404's serial number in the space provided.

Serial Number: 0154632

Your HTX-404's buttons each have two or more functions. The abbreviation for the function is printed on, above, to the left, or below the button. For functions below or to the left of the button, the function abbreviation is printed in orange. To make this manual clearer, buttons are referred to by the function being used. For example, the lower right button on the keypad is referred to in different sections as **D**, **CLR**, **VF**, and **M→VFO**.

To activate certain HTX-404 features you must press **F** (function) plus another button. Such key combinations are printed with a **+** between the button names. For example, **F + BEEP** means press and hold down **F** while you press **BEEP**.

Also, this manual uses the following text conventions:

Button names are printed in bold, capital letters: **BEEP**, **DTMF**, and so on.

Words, symbols, and numbers that appear on the display are printed in a distinctive typeface: 446.940, M-CH, and so on.

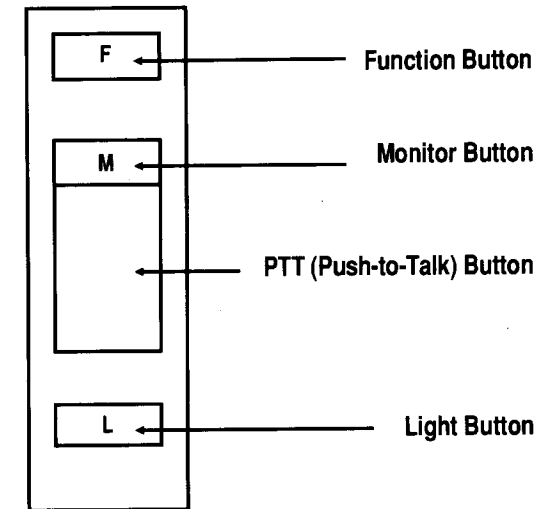

HTX-404 Side View

For a complete key reference, see the Key Index at the back of the manual.

Introduction to Amateur Radio

We designed your HTX-404 handheld transceiver to be the perfect first radio for anyone entering the exciting world of amateur radio and a great additional transceiver for experienced amateur radio operators. You will find that your HTX-404 opens a door to the world from almost anywhere!

All you need is an Amateur Radio Operator's License, Technician Class or higher, issued by the Federal Communications Commission (FCC). If you do not have a license, you will find that it is easy to get one, and that there is much help available. Here are a few tips to help you get started.

First, go ahead and turn on your HTX-404 and use the receiver to tune around on the band to hear what is going on. Do not even *think* of transmitting until you get your license. **That is very important.** Transmitting without a license is a violation of federal law that can lead to severe penalties. Also, ham operators take FCC rules very seriously and want nothing to do with *bootleggers* — their term for people who operate without a license.

Second, find out if there is a ham radio club in your area. There are thousands of clubs across the country, so there is probably at least one in or near your own community. The people at the Radio Shack store where you bought your HTX-404 might be able to tell you. If not, and if you do not hear anyone talking about a local club in your area as you tune around the band with your HTX-404, write to the American Radio Relay League (ARRL) for information on how to contact their local affiliate. Most clubs welcome newcomers and are glad to help you get your license.

Next, start studying for your license. Do not let the word *study* scare you, because most people can go from knowing absolutely nothing about amateur radio to passing the Novice and Technician written exams in less than a month.

The exams test your knowledge of basic radio regulations and elementary radio theory. While Morse code is no longer required for a Technician Class license, we encourage you to learn Morse now, so you can advance to additional operating privileges.

Many clubs teach license classes (a fun and easy way to learn about amateur radio), and there are good books, cassette tapes, computer programs, and many other study aids available. Radio Shack stores sell FCC License Preparation study guides for Novice, Technician, and General Class licenses.

When you are ready to take the test, you do not have to go to an imposing Federal office building in a big city to take the test, because these days the FCC has authorized ham volunteers to give all the exams. The examiners for a Novice license test can be any two ham operators with general or higher class licenses who are at least 18 years of age and are not related to you. And the Novice exam is free.

If you pass the Novice exam, you can immediately take the Technician exam. You must pay a small fee to take the Technician exam, and the test must be administered by a three-member Volunteer Examiner Team. You can get a schedule of exam opportunities in your area from the ARRL.

The Technician Class license lets you use the entire range of your HTX-404 to communicate directly with other operators, communicate through repeaters, or connect to a terminal-node controller and use packet to directly send and receive information with a computer.

We have mentioned the ARRL several times. That is because the League is the national organization that represents amateur radio in the United States. The League has more than 150,000 members; most of them are ham operators, but many are ham operators-to-be. Here is the address of ARRL headquarters.

**The American Radio Relay League
225 Main Street
Newington, CT 06111**

The ARRL staff helped us prepare this section of the owner's manual, and they would be glad to hear from you if you need more information, or if you would like to join!

Amateur radio is a great hobby that has enriched the lives of millions of people all over the world. We take pride in bringing you the HTX-404 to enrich your life.

Preparation

This section provides information on providing power to your HTX-404 and also tells you how to use the HTX-404's accessories.

POWER SOURCES

You can operate your HTX-404 from any of the following power sources:

- Rechargeable power pack (supplied with charger)
- Six alkaline AA batteries (using the supplied alkaline pack)
- Vehicle battery power (using an optional adapter)
- AC power (using an optional adapter)

Operating from the Rechargeable Power Pack

The supplied nickel cadmium rechargeable power pack provides 7.2 volts and can operate your HTX-404 at 2.5 watts (typical power) with the **LOW POWER** button out. As supplied, the power pack is fully discharged.

Charge the pack for 10 hours using the supplied charger before you operate the HTX-404 from the rechargeable pack. Follow these steps to charge the pack.

Note: To ensure a full charge, be sure the batteries are at room temperature (above 65°F) when you charge them. Cold batteries do not fully charge.

1. If the pack is attached to the HTX-404, turn off the HTX-404. Do not operate the HTX-404 while you charge the power pack.

Note: You can remove the power pack from the HTX-404 to charge it, and operate the HTX-404 from one of the other power sources.

2. Plug the supplied charger's barrel plug into the **CHARGE** jack on the back of the power pack.
3. Plug the charger into a standard AC outlet. The **CHARGE** indicator lights.

When power is low, **BATT** appears on the display when you press **PTT**.

You can buy extra power packs through your local Radio Shack store.

Cautions:

- To prevent permanent nickel-cadmium power loss, never charge the power pack in an area where the temperature is above 80°F.
- Never use a charger other than the one supplied to charge the power pack. Even chargers with the same voltage and current ratings could permanently damage the HTX-404 or the power pack. Order a replacement charger at your local Radio Shack store.



The dark space above contains a caution to recycle NiCd batteries.

Using Alkaline Batteries

The supplied battery holder lets you power the HTX-404 from six AA batteries (not supplied). This battery holder supplies 9 volts and can operate your HTX-404 at 4 watts (typical power) with the **LOW POWER** button out. Follow these steps to load or replace batteries in the alkaline battery holder.

1. Hold the outer battery holder case and push down on the center of the battery holder, as shown.

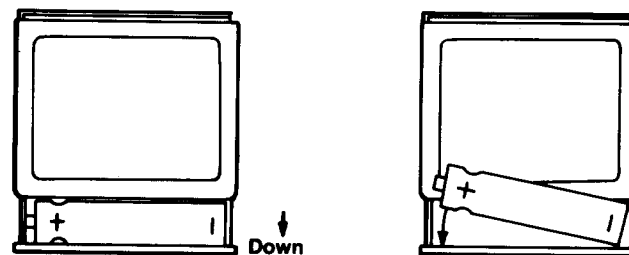

2. Remove old batteries, if necessary, and install six fresh AA alkaline batteries as indicated by the markings (+ and -) in the battery holder.
3. Press the battery holder into the battery holder case.

When power is low, **BATT** appears when you press **PTT**.

Caution: Never mix different types of batteries, and never mix old and new batteries.

Operating from Vehicle Battery Power

A DC power cord (Radio Shack Cat. No. 270-1533) supplies 13.8 volts (typical) to your HTX-404 and can operate your HTX-404 at 5 watts with the **LOW POWER** button out. Follow these steps to operate from vehicle battery power.

1. Plug the power cord's barrel plug into the HTX-404's **EXT DC** jack.

Caution: Never plug the power cord into the rechargeable power pack's **CHARGE** jack. Doing so can damage the power pack and the HTX-404.

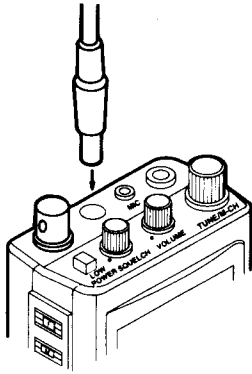

2. Plug the power cord's cigarette-lighter plug into your vehicle's cigarette-lighter socket.

If the HTX-404 does not operate, remove the power cord's plug from the cigarette-lighter socket and check the socket for debris. Clean the socket, if necessary, and try again.

Operating from AC Power

Operation from AC power requires an adapter or power supply (neither is supplied). Operate the HTX-404 from AC power using either the 1-amp 12-volt DC adapter (Cat. No. 273-1653) or our regulated 2.5-amp power supply (Cat. No. 22-120).

The 1-amp adapter connects quickly and requires no soldering, but only lets you operate your HTX-404 at 2 watts (typical power) with the **LOW POWER** button out. The 2.5-amp power supply operates your HTX-404 at about 5 watts with the **LOW POWER** button out and is better isolated from 60 Hz noise.

To use the 1-Amp, 12-volt DC adapter:

1. Connect the barrel plug with the tip set to positive.
2. Insert the adapter's barrel plug into the HTX-404's **EXT DC** jack.

Caution: Never insert the adapter's barrel plug into the rechargeable power pack's **CHARGE** jack. Doing so can damage the power pack and the HTX-404.

3. Plug the adapter into an AC outlet.

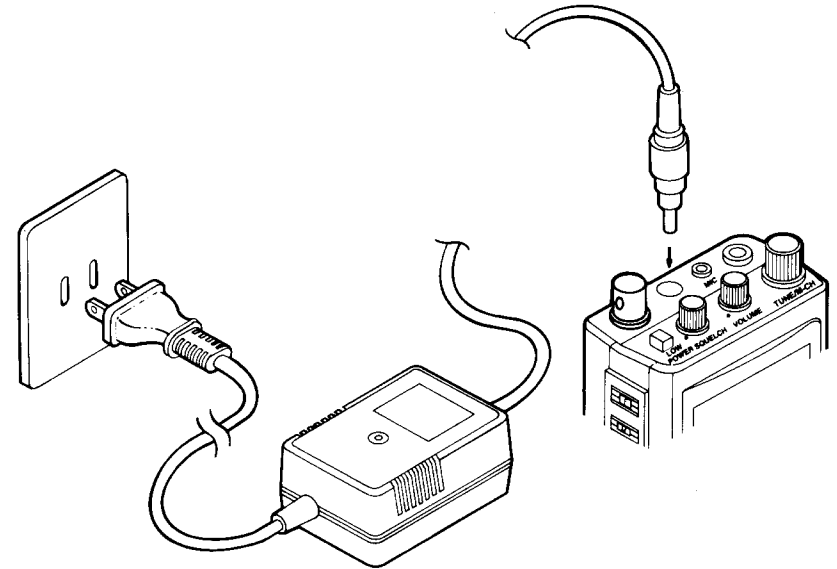

To use the regulated 2.5-amp power supply, you need the following materials:

- ✓ Power supply (Cat. No. 22-120)
- ✓ Two-conductor 18-gauge wire (Cat. No. 278-567)
- ✓ DC power connector (Cat. No. 274-1567)
- ✓ Soldering iron and solder
- ✓ Voltmeter or multimeter

Follow these steps to power the HTX-404 from the regulated 2.5-amp power supply.

1. Cut the two-conductor wire to the length power cord you need.
2. Strip about 1/2-inch of insulation from each end of both conductors.



3. Solder one end of the wire to the DC power connector, with the red lead connected to the center terminal, and the black lead connected to the outer casing.

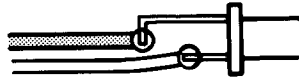

4. Melt a small amount of solder onto the other end of the wire. Then connect the red lead to the power supply's + terminal and connect the black lead to the power supply's - terminal.

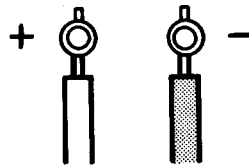

5. Plug in the power supply and turn it on. Use the meter to confirm that you have correctly wired the power connector with the tip positive and the outer case negative.

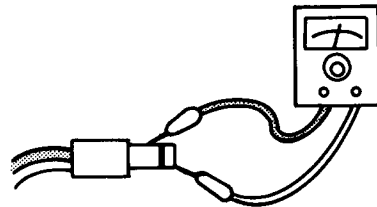

6. Turn off the power supply and plug the power connector into the HTX-404's EXT DC jack.

Caution: Never plug the power connector into the rechargeable power pack's CHARGE jack. Doing so can damage the power pack and the HTX-404.

7. Turn on the power supply.

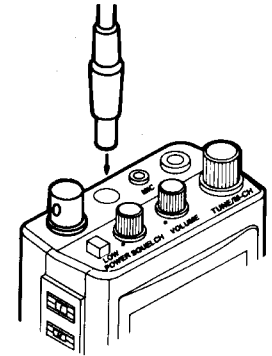

Backup Battery

Your HTX-404 uses a lithium battery to keep stored options in memory when you disconnect it from a power source. This battery should last 3 to 5 years under normal conditions. When the HTX-404 frequently displays ER1, the backup battery needs to be replaced.

Note: To clear the ER1 error message, reset the HTX-404. See "Resetting the HTX-404."

The backup battery is not user-serviceable. Take the HTX-404 to your local Radio Shack store to have the battery replaced by a Radio Shack repair center.

CONNECTING THE ANTENNA

You must connect an antenna to your HTX-404 before you transmit. Your HTX-404 comes with a flexible antenna. The HTX-404's antenna connector makes it easy to connect other types of antennas. Radio Shack stores sell a discone antenna (Cat. No. 20-013) and a center-loaded telescoping whip antenna (Cat. No. 20-006) you can use with your HTX-404.

To use the supplied antenna, slip the antenna's connector over the BNC jack and twist the antenna to lock it in place.

To use an external antenna, attach the appropriate connector adapter to the end of the antenna cable. Then slip the connector over the BNC jack and twist the connector to lock it in place.

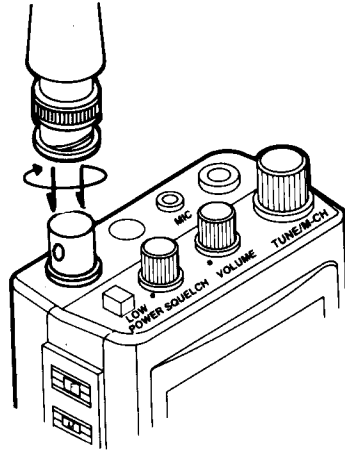

Warning: When installing or removing an outdoor antenna, use extreme caution. If the antenna starts to fall, let it go! It could contact overhead power lines. If the antenna touches the power line, contact with the antenna, mast, cable, or guy wires can cause electrocution and death! Call the power company to remove the antenna. Do not attempt to do so yourself.

ACTIVATING ADDITIONAL FREQUENCIES

As factory set, your HTX-404 operates from 440 MHz to 450 MHz. To set the HTX-404 to operate from 430 MHz to 450 MHz, press and hold **F+A** while you turn on the transceiver. Then hold in **F** while you press **987.6**. The HTX-404 beeps when you press the last digit.

Notes:

- This modification does not affect the HTX-404's performance in any way other than increasing the frequency coverage. The additional frequencies cover areas not normally used in repeater operation.
- You must reset the HTX-404 to restore the original coverage.

ATTACHING THE BELT CLIP

You can attach the provided belt clip to your HTX-404. Use the supplied screws as shown.

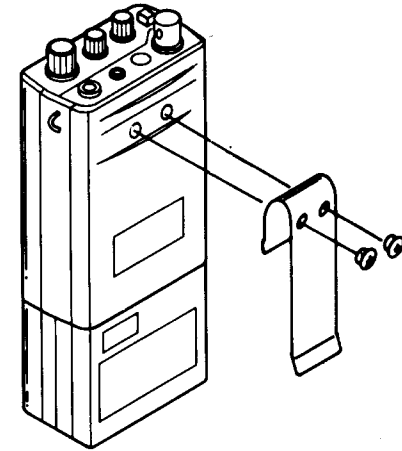

ATTACHING THE HAND STRAP

Loop the supplied hand strap's key ring through the hand strap tab, as shown.

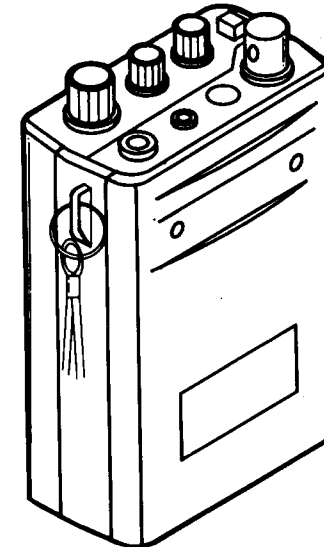

USING AN EXTERNAL MICROPHONE

You can use an external microphone with your HTX-404. When you connect an external microphone, the internal microphone does not work, but the internal PTT (push-to-talk switch) is not affected. If your microphone has a $\frac{3}{32}$ -inch (2.5 mm) submini plug, plug the microphone cable into the HTX-404's MIC jack.

See the following two diagrams for specific microphone connections.

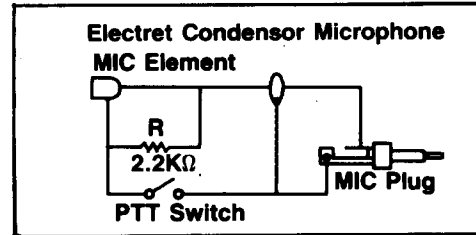
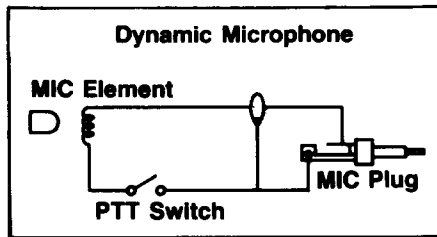

USING AN EXTERNAL SPEAKER

In a noisy area, an external speaker positioned in the right place might provide more comfortable listening. Radio Shack stores sell an extension speaker (Cat. No. 21-549) and an amplified communications extension speaker (21-541). Plug the speaker cable's $\frac{1}{8}$ -inch (3.5 mm) mini plug into the HTX-404's SP jack. This disconnects the internal speaker.

For the most efficient operation when you carry the HTX-404 on your belt, connect a combination speaker/microphone (such as Cat. No. 19-310) to your HTX-404 and hang the speaker/mic on your collar.

If your vehicle's stereo has a front-panel auxiliary input jack, you can listen to your transceiver through your stereo's speakers by plugging one end of a $\frac{1}{8}$ -inch stereo cable (Cat. No. 42-2387) into the stereo's jack. Then plug the other end of the cable into a mono-to-stereo audio plug (Cat. No. 274-368) and insert that plug in your HTX-404's SP jack.

If your vehicle has a cassette player, you can connect your HTX-404 to your vehicle's audio system using a CD-to-cassette adapter (Cat. No. 12-1951) and a mono-to-stereo audio plug (Cat. No. 274-368). Simply insert the adapter in your vehicle's cassette player, connect the adapter's plug to the mono-to-stereo plug, insert the plug in the HTX-404's SP jack, and turn on your cassette player.

USING THE HTX-404 WITH PACKET RADIO

You can connect your HTX-404 directly to a packet radio terminal node controller. See the following diagram for a suggested connection.

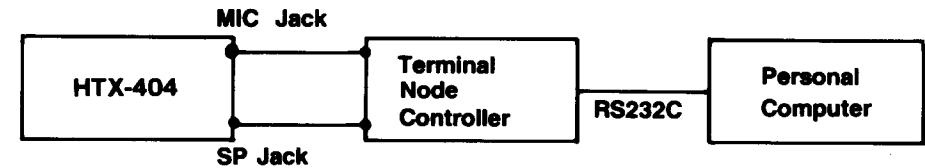

RESETTING THE HTX-404

When you first use the HTX-404, if the display shows ER1, or if you ever want to reset the HTX-404's options to the factory defaults and clear all memories, follow these steps.

Warning: This procedure clears all stored information.

1. Turn off the HTX-404.
2. Press and hold down **F+CLR**. Then turn on the HTX-404.

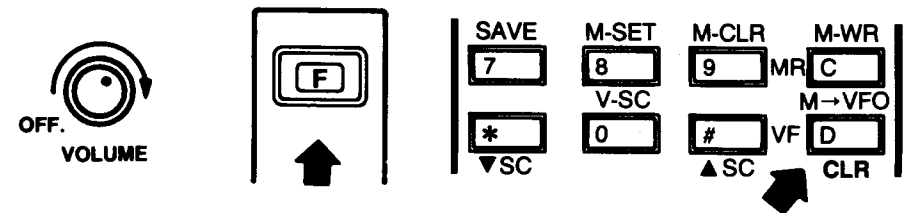

USING THE LIGHT

Press L on the side of the HTX-404 to turn on the display light for about 5 seconds. To turn off the light sooner, press L again. If you want the light to stay turned on, press **F+L** at the same time. The light stays on until you press L again or turn off the HTX-404.

Basic Operation

This section has the basic information you need to use your HTX-404.

SETTING SQUELCH AND VOLUME

Rotate **VOLUME** clockwise and **SQUELCH** counterclockwise until you hear a hissing sound. Then slowly rotate **SQUELCH** clockwise until the noise stops. Leave **VOLUME** set to a comfortable level.

If the HTX-404 picks up unwanted weak transmissions, rotate **SQUELCH** clockwise to decrease the HTX-404's sensitivity to signals.

SELECTING A FREQUENCY

You can use any of three methods to select a frequency.

- Direct entry
- Tune control
- Scanning for frequencies

Tuning Using Direct Entry

Your HTX-404 transmits and receives on frequencies between 440.000 and 450.000 MHz unless you activate additional frequencies (see "Activating Additional Frequencies"). To quickly tune to a frequency, enter the frequency using the keypad.

1. Turn on the HTX-404.
2. Press **VF**.
3. Use the keypad to enter the last five digits of the frequency. For example, to enter 446.940, press **46940**.

Notes:

- If you make a mistake, press **CLR** and repeat Step 3.
- The HTX-404 rounds the last digit down to 0 or 5.

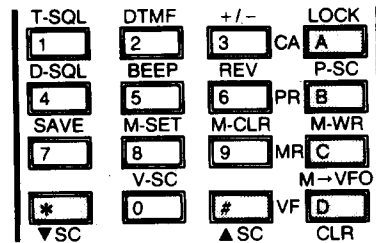

Tuning Using the Tune Control

You can quickly tune to a nearby frequency by rotating **TUNE** on top of the HTX-404.

1. Turn on the HTX-404.
2. Press **VF**.
3. Rotate **TUNE** counterclockwise to tune down or clockwise to tune up. The HTX-404 tunes down or up one frequency step per click. To change the frequency step, see "Setting the Frequency Step Rate."

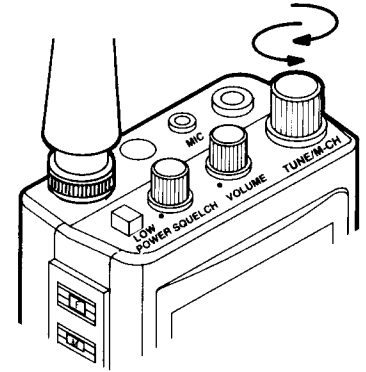

Scanning for Active Frequencies

You can search for activity on a frequency by pressing and holding down **▲SC** or **▼SC** for at least 1 second. The HTX-404 begins to scan up or down the full frequency range, and stops on active frequencies. To scan only a selected frequency range, press **F + ▲SC** or **F + ▼SC**. See "Setting Scan Options" to see how to change the scanning range, the frequency step, the scan resume condition, and the scan delay time. The following are the factory presets for these options.

Frequency Step:	20 kHz
Scan Resume Condition:	Resumes scanning in 10 seconds, regardless of absence or presence of carrier.
Scan Delay:	Not activated.
Scan Limits:	440 MHz to 450 MHz

To stop scanning, press **▲SC**, **▼SC**, **CA**, **PR**, **MR**, **VF**, or turn off the HTX-404.

Scanning for a Vacant Frequency

In some areas where the 440 MHz band is used heavily, you might have trouble quickly finding a frequency not being used. To quickly scan for a vacant frequency, press **F + V-SC**. The HTX-404 scans up or down from the current frequency to the first unused frequency. To change the vacant scan direction, see "Vacant Scan Direction."

RECEIVING TRANSMISSIONS

To receive transmissions, turn on the HTX-404, adjust the volume and squelch, and tune to a frequency.

TRANSMITTING

There are two basic types of communication you can use with this HTX-404. These are referred to as simplex and duplex.

With simplex transmission, you transmit and receive on the same frequency, and are usually communicating with a station within a couple of miles of your location.

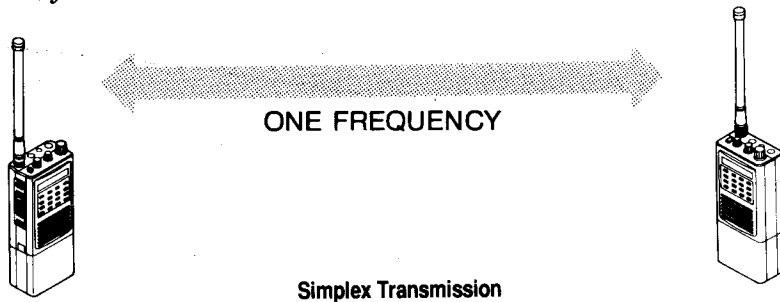

Duplex transmission is what you use when you communicate using a repeater. You transmit to the repeater on one frequency (the input frequency), and the repeater retransmits the signal at a different frequency (the output frequency). Since repeater antennas are usually located on radio towers, tall buildings, or mountains, you can hit a repeater from much further away than other mobile or fixed stations. This lets you talk to stations much further away.

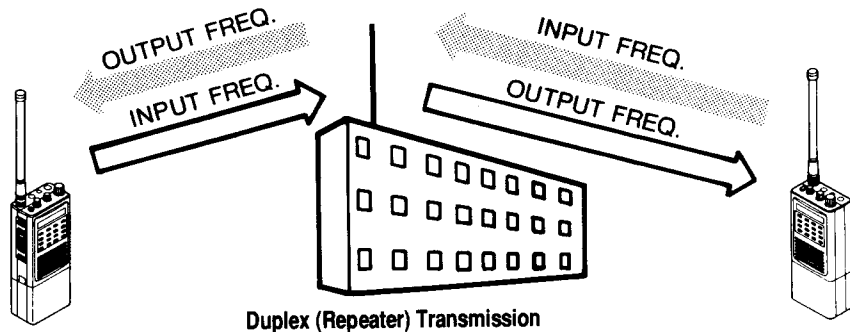

Caution: Do not transmit if you do not have a Technician Class or higher license issued by the FCC. Doing so is illegal.

Follow these steps to communicate using simplex communications.

1. Turn on the HTX-404.
2. Select the desired frequency.
3. If + or - is on the display, repeatedly press **F + +/-** until neither symbol appears.
4. Press **LOW POWER** so the button is down. In this position, your HTX-404 transmits at about 1 watt.
5. Begin communication.

If the other party advises that you need to improve your signal, press **LOW POWER** so the button is up. In this position, your HTX-404 transmits at the highest power it can, depending on the power source. See "Power Sources" or "Specifications" for these power levels. Remember to switch back to low power whenever possible, to comply with the FCC rules that require you to use the minimum power necessary to maintain communications.

Follow these steps to communicate using duplex communications (through a repeater).

1. Turn on the HTX-404.
2. Tune to the desired receive (output) frequency.
3. If the transmit (repeater's input) frequency is 5 MHz **above** the receive (repeater's output) frequency, repeatedly press **F + +/-** until + appears in the display. If the transmit frequency is 5 MHz **below** the receive frequency, repeatedly press **F + +/-** until - appears on the display. If the frequency separation is not 5 MHz, either set a new default frequency separation or store the frequency pair in one of the scanner's memories. (See "Using Memory Channels" and "Duplex Separation Default.")

LOCKING THE KEYPAD

To lock the HTX-404's keypad so you do not accidentally change a setting, press **F + LOCK**. **LOCK** appears on the display. This locks all front-panel buttons and the tune control. **PTT**, **VOLUME**, and **SQUELCH** still operate. To release the lock, press **F + LOCK** again.

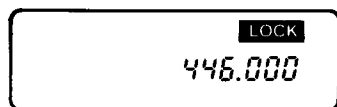

SETTING THE KEY ENTRY BEEP

Each time you press a key, the HTX-404 sounds a beep. To turn off the beep, press **F + BEEP**. The key beep does not sound for this or subsequent key presses. To turn on the key beep, press **F + BEEP** again.

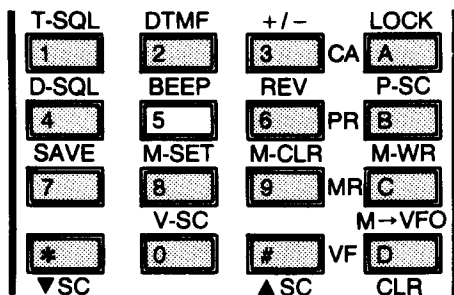

REVERSING THE OFFSET

To reverse the transmit and receive frequencies when you are operating duplex, press **F + REV**.

For example, if you are set to 449.940 with a - offset, pressing **F + REV** makes the HTX-404 receive on 444.940 and transmit on 449.940.

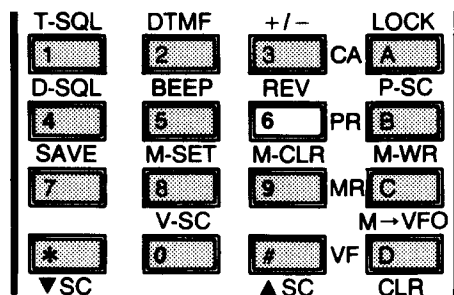

USING MEMORY CHANNELS

Your HTX-404 has 16 memory channels in three groups.

- One calling-frequency memory
- Three priority-frequency memories
- 12 standard memories

Changing Memory Options

You can program each memory with a different frequency offset (see "Transmitting") and subaudible tones (see "Tone-Coded Squelch (CTCSS)"). Follow these steps to change the settings for a memory location.

1. Tune to the memory channel. See the instructions for the memories on the following pages.
2. Press **F + M-SET**. The HTX-404 displays **tF** followed by the transmit frequency.
3. Rotate **TUNE** to change the transmit frequency.
4. Press **▼SC** to set the transmit subaudible tone frequency. The HTX-404 displays **tC** followed by the transmit subaudible tone frequency.
5. Rotate **TUNE** to change the transmit subaudible tone frequency. Set the option to **OFF** to not transmit a subaudible tone.
6. Press **▼SC** to set the receive subaudible tone frequency. The HTX-404 displays **rC** followed by the receive subaudible tone frequency.
7. Rotate **TUNE** to change the receive subaudible tone frequency. Set the option to **OFF** to not require a receive subaudible tone.
8. Press **PTT** to save the settings in the selected memory channel.

Using the Calling-Frequency Memory

The calling-frequency memory stores a single frequency you can quickly tune to at any time. Follow these steps to save a frequency in the calling-frequency memory.

1. Press **VF**.
2. Tune to the frequency you want to save.
3. Set the offset to the desired setting (+, -, or off) by pressing **F + +/-**.
4. Turn on the tone-squelch option by pressing **F + T-SQL**, if necessary.
5. Press **CA**.
6. Press and hold down **F + M-WR** for at least 1 second.

The HTX-404 stores the tuned frequency, the frequency offset direction, and the setting of the tone squelch option. If you need to set a frequency offset other than the default 5 MHz separation, or if you need to change the tone-squelch frequency, see "Changing Memory Options."

To use the calling-frequency memory, press **CA** at any time. The HTX-404 immediately moves to the calling frequency. To return to the previous settings, press **CA** again. Or press **VF** to return to the last manually-tuned frequency setting.

Using the Priority-Frequency Memories

The HTX-404 has three priority-frequency memories. The HTX-404 can periodically scan these frequencies during manual, calling-frequency memory, or standard memory operation. Follow these steps to store frequencies in the priority-frequency memories.

1. Press **VF** and tune to the frequency you want to save.
2. Press **F** and rotate **TUNE** until either P1, P2, or P3 appears to the left of the tuned frequency.
3. Set the offset to the desired setting (+, -, or off) and turn on the tone-squelch option, if necessary.
4. Press **F+M-WR** for at least 1 second to store the tuned frequency in the selected priority-frequency memory.
5. To change the frequency separation or subaudible tones, see "Changing Memory Options." Each priority frequency memory can have different settings.

To set the HTX-404 to a priority frequency, press **PR**. Then do one of the following to select one of the three memories:

- ✓ Rotate **TUNE**
- ✓ Press **▲SC** or **▼SC**
- ✓ Press 1, 2, or 3

To have the scanner check the priority-frequency memories for activity, press **VF**. Then press **F + P-SC** for at least 1 second. The HTX-404 checks the priority-frequency memories every 4 seconds. To change the priority scan time, see "Setting the Priority Scan Time."

To continuously scan the three priority frequency memories, press **PR**. Then press and hold down **▲SC** or **▼SC** for at least 1 second.

Note: You must store more than one priority frequency in memory to continuously scan priority-frequency memories.

Using the Standard Memories

Your HTX-404 has 12 standard memories into which you can store frequently-accessed frequencies for quick access. Follow these steps to store frequencies into standard memories.

1. Press **VF** and tune to a frequency you want to store.
2. Press **F** and rotate **TUNE** until the memory number to the left of the frequency display shows the standard memory you want to store the frequency into.
3. Set the offset to the desired setting (+, -, or off) and turn on the tone-squelch option, if necessary.
4. Press **F + M-WR** for at least 1 second to store the tuned frequency into the selected standard memory.
5. To change the frequency separation or subaudible tones, see "Changing Memory Options." Each memory location can have different settings.

To set the HTX-404 to a standard memory, press **MR**. Then rotate **TUNE** or press **▲SC** or **▼SC** to select one of the 12 memories.

To continuously scan standard memories, press **MR**. Then press and hold down **▲SC** or **▼SC** for at least 1 second.

Note: The HTX-404 stops scanning according to the scan options you have set. See "Scan Options" for more information.

Clearing Memories

Follow these steps to clear a memory.

1. Press **PR** or **MR** and select the number for the memory you want to clear.
2. Press **F+M-CLR** to clear the settings stored in the current memory.

Note: You cannot clear Standard Memory 1 or the calling-frequency memory. You can only change the memory settings for these memories.

Moving a Memory Channel to the Manual Mode

Follow these steps to quickly move a frequency from a memory channel to the manual (VFO) mode.

1. Select the memory channel.
2. Press **F + M**→**VFO**.

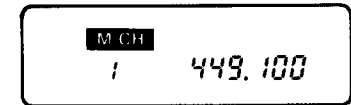

All settings for the selected memory move to the VFO mode.

REVIEWING PROGRAMMED OPTIONS

Follow these steps to view the transmit frequency and the subaudible transmit and receive tone settings for a memory or the directly tuned frequency.

1. Press **CA**, **PR**, **MR**, or **VF** and select the memory or frequency you want to check.
2. If you want to check the subaudible tone settings, press **F + T-SQL** so **T-SQL** appears on the display.
3. Press and hold **M** (located above **PTT**). The HTX-404's squelch opens, and the display shows the transmit frequency for about 1 second, followed by the subaudible transmit tone and the subaudible receive tone.

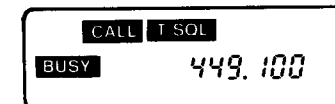
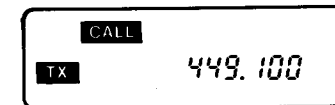

Advanced Operation

This section describes some of your HTX-404's more advanced features.

CONFIGURATION MENU

Your HTX-404 has a configuration menu that lets you modify operation settings. Each of the following sections explains how and when to use each configuration setting. Follow these steps to turn on the configuration menu and select options.

1. Press **VF**.
2. Press **F + M-SET**. The first menu item appears.
3. Press **▲SC** or **▼SC** to step down or up through the menu items. Rotate **TUNE** to change the setting for any menu item.
4. Press **PTT** to exit the configuration menu and save all settings.

The configuration menu appears in the following order:

Code	Factory Default	Explanation
oS	5.000	Duplex separation (offset)
tC	OFF	Transmit subaudible tone
rC	OFF	Receive subaudible tone
Sr	20	Frequency step
Sc	ti	Scan resume
Sd	2.0	Scan delay time
S1	440.000	Lower scan range limit
S2	450.000	Upper scan range limit
ud	dn	Vacant channel scan direction
PS	1-16	Power save duty cycle
tE	OFF	Transmit inhibit
tO	OFF	Transmit time-out
Lb	4	Priority-frequency channel lookback time
Ar	OFF	Touch-tone auto-reply

See the following sections for complete information regarding these functions.

DUPLEX SEPARATION DEFAULT

The duplex separation default (offset) controls the offset between the transmit frequency and the receive frequency when you use the HTX-404 in duplex mode, as with a repeater. Typically, on the 440 MHz band, repeaters receive at a frequency 5 MHz lower or higher than they retransmit (repeat) on. For example, if a repeater's input frequency is 444.340 MHz, its output frequency is 449.340 MHz. The following is a list of the most commonly used repeater pairs.

Output	Input	Output	Input	Output	Input	Output	Input	Output	Input
442.000	447.000	442.600	447.600	443.200	448.200	443.800	448.800	444.400	449.400
442.025	447.025	442.625	447.625	443.225	448.225	443.825	448.825	444.425	449.425
442.050	447.050	442.650	447.650	443.250	448.250	443.850	448.850	444.450	449.450
442.075	447.075	442.675	447.675	443.275	448.275	443.875	448.875	444.475	449.475
442.100	447.100	442.700	447.700	443.300	448.300	443.900	448.900	444.500	449.500
442.125	447.125	442.725	447.725	443.325	448.325	443.925	448.925	444.525	449.525
442.150	447.150	442.750	447.750	443.350	448.350	443.950	448.950	444.550	449.550
442.175	447.175	442.775	447.775	443.375	448.375	443.975	448.975	444.575	449.575
442.200	447.200	442.800	447.800	443.400	448.400	444.000	449.000	444.600	449.600
442.225	447.225	442.825	447.825	443.425	448.425	444.025	449.025	444.625	449.625
442.250	447.250	442.850	447.850	443.450	448.450	444.050	449.050	444.650	449.650
442.275	447.275	442.875	447.875	443.475	448.475	444.075	449.075	444.675	449.675
442.300	447.300	442.900	447.900	443.500	448.500	444.100	449.100	444.700	449.700
442.325	447.325	442.925	447.925	443.525	448.525	444.125	449.125	444.725	449.725
442.350	447.350	442.950	447.950	443.550	448.550	444.150	449.150	444.750	449.750
442.375	447.375	442.975	447.975	443.575	448.575	444.175	449.175	444.775	449.775
442.400	447.400	443.000	448.000	443.600	448.600	444.200	449.200	444.800	449.800
442.425	447.425	443.025	448.025	443.625	448.625	444.225	449.225	444.825	449.825
442.450	447.450	443.050	448.050	443.650	448.650	444.250	449.250	444.850	449.850
442.475	447.475	443.075	448.075	443.675	448.675	444.275	449.275	444.875	449.875
442.500	447.500	443.100	448.100	443.700	448.700	444.300	449.300	444.900	449.900
442.525	447.525	443.125	448.125	443.725	448.725	444.325	449.325	444.925	449.925
442.550	447.550	443.150	448.150	443.750	448.750	444.350	449.350	444.950	449.950
442.575	447.575	443.175	448.175	443.775	448.775	444.375	449.375	444.975	449.975

To operate with a repeater, you must transmit on the repeater's input frequency and receive on the repeater's output frequency. If you frequently use a repeater that does not have a 5MHz offset, we recommend you program the repeater frequency into one of the HTX-404's memories. You can override the default offset for each memory.

To change the default offset, follow the steps in "Configuration Menu" to display the oS menu item, and rotate **TUNE** to change the offset. The HTX-404 lets you set the offset to be in the range from 0 MHz to 10 MHz in steps as set by the frequency step option.

TONE-CODED SQUELCH (CTCSS)

Some repeaters require that you transmit a subaudible tone to key-up the repeater. You can set your HTX-404 to transmit any of the 38 standard subaudible tones. You can also limit incoming calls by setting your HTX-404 to open the squelch only when someone transmits a subaudible tone you set.

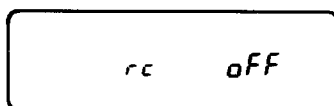
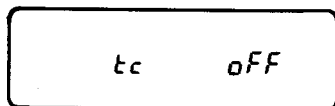

To set a subaudible transmit tone, follow the steps in “Configuration Menu” to display **tc**. Then rotate **TUNE** to select the subaudible tone. If you do not want to transmit a subaudible tone, rotate **TUNE** to select **OFF**.

To set a subaudible receiver tone, follow the steps in “Configuration Menu” to display **rc**. Then rotate **TUNE** to select the subaudible tone. If you do not want to use the receiver subaudible tone squelch, but are using the transmit subaudible tone to activate a repeater, rotate **TUNE** to select **OFF**. Otherwise, you only hear transmissions that have the correct subaudible tone when you activate tone squelch.

To turn on the subaudible tone feature, press **F + T-SQL**. When you transmit, the HTX-404 includes the subaudible tone in the signal. To receive, the incoming signal must have the correct subaudible tone. You can override the default subaudible tones for any memory.

Code	Freq (Hz)	Code	Freq (Hz)	Code	Freq (Hz)	Code	Freq (Hz)	Code	Freq (Hz)
XZ	67.0	ZZ	91.5	2B	118.8	5A	156.7	M2	210.7
XA	71.9	ZA	94.8	3Z	123.0	5B	162.2	M3	218.1
WA	74.4	ZB	97.4	3A	127.3	6Z	167.9	M4	225.7
XB	77.0	1Z	100.0	3B	131.8	6A	173.8	M5	233.6
WB	79.7	1A	103.5	4Z	136.5	6B	179.9	M6	241.8
YZ	82.5	1B	107.2	4A	141.3	7Z	186.2	M7	250.3
YA	85.4	2E	110.9	4B	146.2	7A	192.8		
YB	88.5	2A	114.8	5Z	151.4	M1	203.5		

SCAN OPTIONS

Several menu items control how your HTX-404 operates when you scan. The following sections describe how to set the frequency step rate, the scan resume condition, the scan delay duration, and the scan limits.

Frequency Step Rate

The frequency step rate affects the scanning mode, the tune control, and **▲SC** or **▼SC** tuning. The factory default for the frequency step is 20 kHz. When scanning, the HTX-404 scans up or down 20 kHz per step. To change the frequency step rate, follow the steps in “Configuration Menu” to display the **sr** menu item, and rotate **TUNE** to change the frequency step rate. You can set the step rate to 5, 10, 15, 20, 25, 50, or 100 kHz.

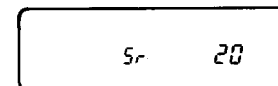

Scan Resume Condition

When you set the HTX-404 to scan either standard memories or the VFO mode, the HTX-404 stops when it encounters a signal strong enough to break squelch. At the factory setting, the HTX-404 resumes scanning in 10 seconds, even if the signal is still present. You can set scan resume to one of the following.

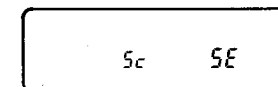
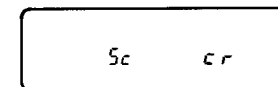
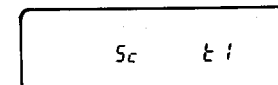

- ti** Resumes scanning in 10 seconds
- cr** Resumes scanning after the carrier drops and the scan delay expires. (See “Setting the Scan Delay.”)
- SE** Does not resume scanning

To change the scan resume condition, follow the steps in “Configuration Menu” to display **sc**. Then rotate **TUNE** to select the scan resume condition.

Note: The scan resume option does not affect priority scan. Priority scan always resumes scanning after the carrier drops.

Scan Delay Duration

When you set the scan resume condition to **CR** (carrier), the HTX-404 resumes scanning after the carrier drops. The scan delay option lets you set the HTX-404 to pause before resuming, so you can hear any reply. The factory default for this option is 2 seconds.

To change the scan delay duration, follow the steps in "Configuration Menu" to display **Sd**. Then rotate **TUNE** to select the scan delay duration. You can set the delay to 0.5, 1, 2, or 4 seconds.

Note: The scan delay option also affects priority scan.

Scan Limits

When you press **F + ▼SC** or **F + ▲SC**, the HTX-404 scans only those frequencies within a range you set with the scan limit options. To set the scan limits, follow the steps in "Configuration Menu" to display **S1**. Use either **TUNE** or the key pad to enter one of the frequency limits. Then press **▼SC** to display **S2** and enter the other frequency limit. You can enter the higher frequency as either limit.

Vacant Scan Direction

The HTX-404's factory default for vacant scan is to scan down until it finds an unused frequency. To change the vacant scan direction, follow the steps in "Configuration Menu" to display **ud**. Then rotate **TUNE** to select either **UP** or **DN**.

POWER-SAVING FEATURE

In the power-save mode, when the HTX-404 is not scanning, it uses only a fraction of the normal power. To do this, it turns on the receiver for about 32 milliseconds to check for a signal, then turns off the receiver for a period of time that depends on the power save menu setting. The factory default for this setting is to use only $\frac{1}{16}$ the normal power.

To set the HTX-404 to save power, press **F + SAVE** until **SAVE** appears on the display. To change the power save setting, follow the steps in "Configuration Menu" to display **PS**. Then rotate **TUNE** to select the power save setting. You can set the power-save setting to 1-2, 1-4, 1-8, or 1-16 ($\frac{1}{2}$, $\frac{1}{4}$, $\frac{1}{8}$, or $\frac{1}{16}$ normal power usage).

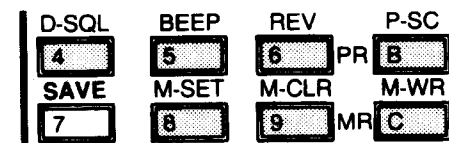
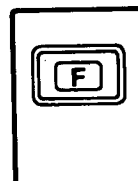

Press **F + SAVE** again to turn off power save.

PREVENTING TRANSMISSIONS

To prevent any transmissions using the HTX-404, turn on the transmit inhibit function.

To turn on this function, follow the steps in "Configuration Menu" to display **tE**. Then rotate **TUNE** to select **ON**. To enable transmissions, set this option to **OFF**.

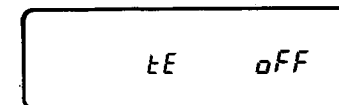

LIMITING TRANSMISSION DURATION

When you communicate on the 70-CM band, you should keep your transmissions as brief as possible. Most repeaters have built-in timers that limit single transmissions to 3 minutes or less. You can set the HTX-404 to stop transmitting and sound a beep if you exceed a set time limit with a single transmission.

To set a transmit limit, follow the steps in "Configuration Menu" to display **t o**. Then rotate **TUNE** to select **oFF**, 30, 60, or 120 seconds.

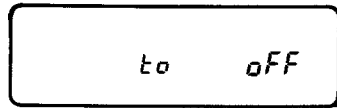

SETTING THE PRIORITY SCAN TIME

When you turn on priority scan, the HTX-404 checks the programmed priority-frequency memories periodically to see if there is any activity. As factory set, the HTX-404 checks the priority-frequency memories every 4 seconds.

To change the priority scan time, follow the steps in "Configuration Menu" to display **L b**. Then rotate **TUNE** to select 4, 8, 12, or 16 seconds.

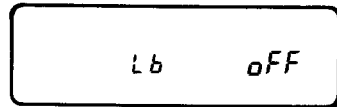

USING TOUCH-TONE FEATURES

Your HTX-404 has a built-in 16-key touch-tone encoder. You can manually send touch tones, or send the tones from one of five DTMF memories. You can also set your HTX-404 so it is silent until it receives a specific sequence of touch tones.

Manually Sending Touch Tones

Some repeaters require you to enter a touch-tone code to key-up the repeater. Also, some repeaters have autopatch devices that let you make telephone calls through the repeater. To manually send the required tones, press and hold down **PTT**. Then enter the touch-tone digits.

Notes:

- You must press **D** twice to send the D touch tone.
- If the HTX-404's auto-reply feature is turned off, you can release **PTT** after you enter the first digit. The HTX-404 continues to accept and transmit the touch-tone signals until you pause at least 1 second.

Storing a DTMF Memory Sequence

You can store frequently-used touch-tone sequences in the HTX-404's nine DTMF memories. Each memory can hold up to 15 digits. Follow these steps to store touch-tone sequences.

1. Press and hold down **F + DTMF** for at least 1 second. The display changes to show the first DTMF memory.
2. Press a digit from 1-9 to select one of the DTMF memories.
3. Enter the touch-tone sequence (up to 15 digits).
4. Press **PTT** to store the sequence and exit the DTMF memory store mode.

To store additional sequences, repeat the above steps.

Note: You must program DTMF memory 1 to use the auto-reply feature. (See "Automatically Sending a DTMF Reply.")

Transmitting a DTMF Memory Sequence

To send a DTMF memory sequence, press and hold down **PTT**. Then press **D** followed by the DTMF memory number you want to transmit (1–9). The HTX-404 transmits the tones.

The HTX-404 has two DTMF memory sequence transmit speeds. To switch between fast and slow, press and hold down **PTT**. Press **D**. Then press **0**.

Note: If the auto-reply feature is tuned off, you can release **PTT** after you press **D**. Enter the DTMF memory number within 1.5 seconds.

Using DTMF Squelch for Paging

The DTMF squelch feature lets you set your HTX-404 to release the squelch only if it receives a specific touch-tone sequence. Follow these steps to set that touch-tone sequence.

1. Press **F + D-SQL** for at least 1 second.
2. Enter the sequence (up to seven digits).
3. Press **PTT** to save the sequence.

To turn on the DTMF squelch, press **F + D-SQL** for less than 1 second. DTMF appears on the display.

Your HTX-404 remains silent until it receives the correct touch-tone sequence. Then it beeps and returns to normal operation. To cancel DTMF squelch, press **F + D-SQL** for less than 1 second so DTMF disappears from the display.

Automatically Sending a DTMF Reply

You can set your HTX-404 to automatically transmit the touch-tone digits stored in DTMF Memory 1 when you enable DTMF squelch and the HTX-404 receives the correct touch-tone sequence. To turn on DTMF auto-reply, follow the steps in “Configuration Menu” to display **Ar**. Then rotate **TUNE** to select **on**.

You should also set this option to **on** if you expect an auto reply from an auto patch, another HTX-404, or other transceiver that has this feature.

Note: You must program a DTMF sequence in DTMF Memory 1 for the auto-reply feature to operate.

ERROR CODES

Your HTX-404 has two error code displays. This section explains each error code.

Er1: Internal RAM Error

Er1 indicates that the HTX-404 has detected an error in its battery-backed up memory. This is most commonly caused by a low lithium backup battery, but can also be caused by static discharge or a physical shock. To clear the error, reset the HTX-404 by turning it off, then holding down **F + D** while you turn it on again. This clears and reinitializes memory.

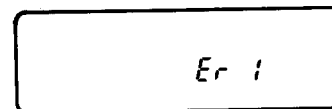

If the transceiver frequently displays the error, have the battery replaced by an authorized Radio Shack repair center.

Er2: PLL Unlock Error

Er2 indicates that the HTX-404's PLL section has unlocked. Have the HTX-404 repaired by an authorized Radio Shack repair center.

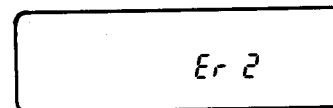

Care and Maintenance

Your HTX-404 70-CM Handheld Transceiver is an example of superior design and craftsmanship. The following suggestions will help you care for your HTX-404 so you can enjoy it for years.



Keep the HTX-404 dry. If it does get wet, wipe it dry immediately. Liquids can contain minerals that corrode the electronic circuits.



Use and store the HTX-404 only in normal temperature environments. Temperature extremes can shorten the life of electronic devices and distort or melt plastic parts.



Handle the HTX-404 gently and carefully. Dropping it can damage circuit boards and cases and can cause the HTX-404 to work improperly.



Keep the HTX-404 away from dust and dirt, which can cause premature wear of parts.



Wipe the HTX-404 with a damp cloth occasionally to keep it looking new. Do not use harsh chemicals, cleaning solvents, or strong detergents to clean the HTX-404.

Modifying or tampering with your HTX-404's internal components can cause a malfunction, and might invalidate its warranty and void your FCC authorization to operate the HTX-404. If your HTX-404 is not performing as it should, take it to your local Radio Shack store for assistance.

Specifications

GENERAL

Frequency Range	440.000 – 450.000 MHz
Frequency Step	5/10/15/20/25/50/100 KHz
Frequency Stability	+/- 10 ppm
Antenna Impedance	50 Ohms Unbalanced
Speaker	8 Ohms
Microphone	Condenser Microphone 1.2 Kohms
Channel Display	LCD 8 Digits
Operating Temperature	14°F to 140°F (-10°C to 60°C)
Size	2 ⁹ / ₁₆ x 4 ⁵ / ₈ x 1 ⁷ / ₈ Inches (65 x 117 x 37 mm)
Weight	1 lbs 3 ozs (540 g)

Supply Voltage:

Alkaline Battery Pack	9 VDC
Ni-Cad Battery Pack (600mAh)	7.2 VDC
External Power Jack	7.2 to 13.8 VDC

RECEIVER

Intermediate Frequencies:

1st IF	45 MHz
2nd IF	455 kHz

Sensitivity:

12db SINAD	0.2 μV
20db NQ	0.35 μV

Squelch sensitivity:

Threshold	0.1 μV
Tight	10 dB Above Threshold

Spurious Response Attenuation	60 dB
Intermodulation Attenuation	60 dB
Adjacent Channel Rejection (25KHz)	50 dB
Modulation Acceptance Bandwidth	9 KHz
Hum and Noise	35 dB

Audio Output Power (10% THD):

7.2V DC	0.3 W
9V DC	0.5 W
12V DC	1 W
13.8V DC	1 W
Audio Distortion	2%
Audio Response	-6 dB/Octave

Current drain:

Stand-By Without Power Save	35 mA
Stand-By With Power Save	25 mA
CTCSS Sensitivity	0.15 μ V
DTMF Squelch Sensitivity	0.2 μ V

TRANSMITTER

RF Power Output:

7.2 VDC	1.5 W
9 VDC	2.5 W
>12 VDC	5 W
Low Power	0.5 W
Maximum Deviation	4.5 KHz
Hum and Noise	35 dB
Audio Distortion	0.5%
Audio Response	+6 dB/Octave
Spurious and Harmonic Emissions	70 dB
Frequency Error	\pm 0.0005%
Microphone Sensitivity	4 mV rms
CTCSS Tone Deviation	0.7 KHz
DTMF Tone Deviation	3.5 KHz

Current drain:

7.2 VDC	1.2 A
9 VDC	1.4 A
12 VDC	1.6 A
13.8 VDC	1.8 A
Low Power	0.8 A

The above specifications are nominal. An individual unit's performance might vary slightly from these specifications.

NOTE: The Digital Schematic on Page 41 is in a separate file, scanned at high resolution and expanded to a full page.

Digital Schematic

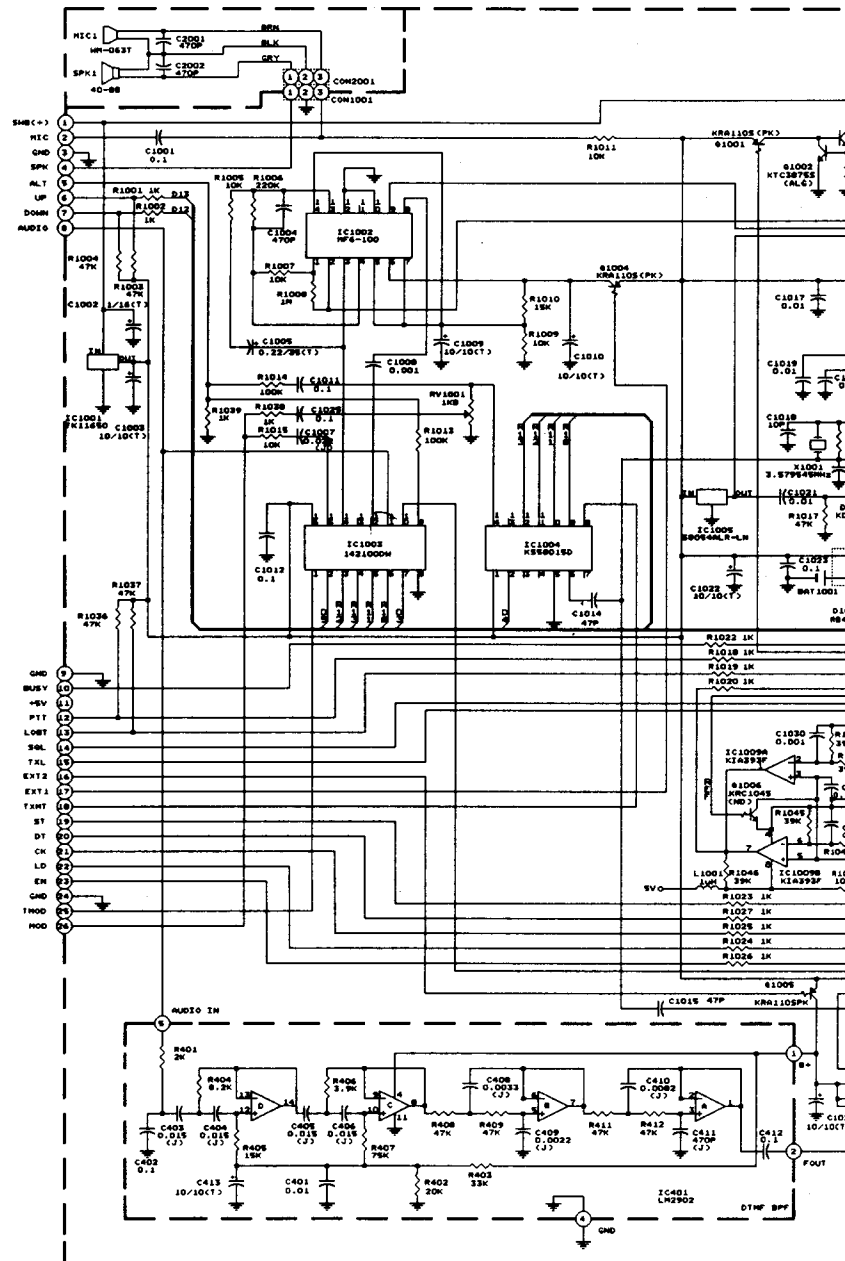

Key Index

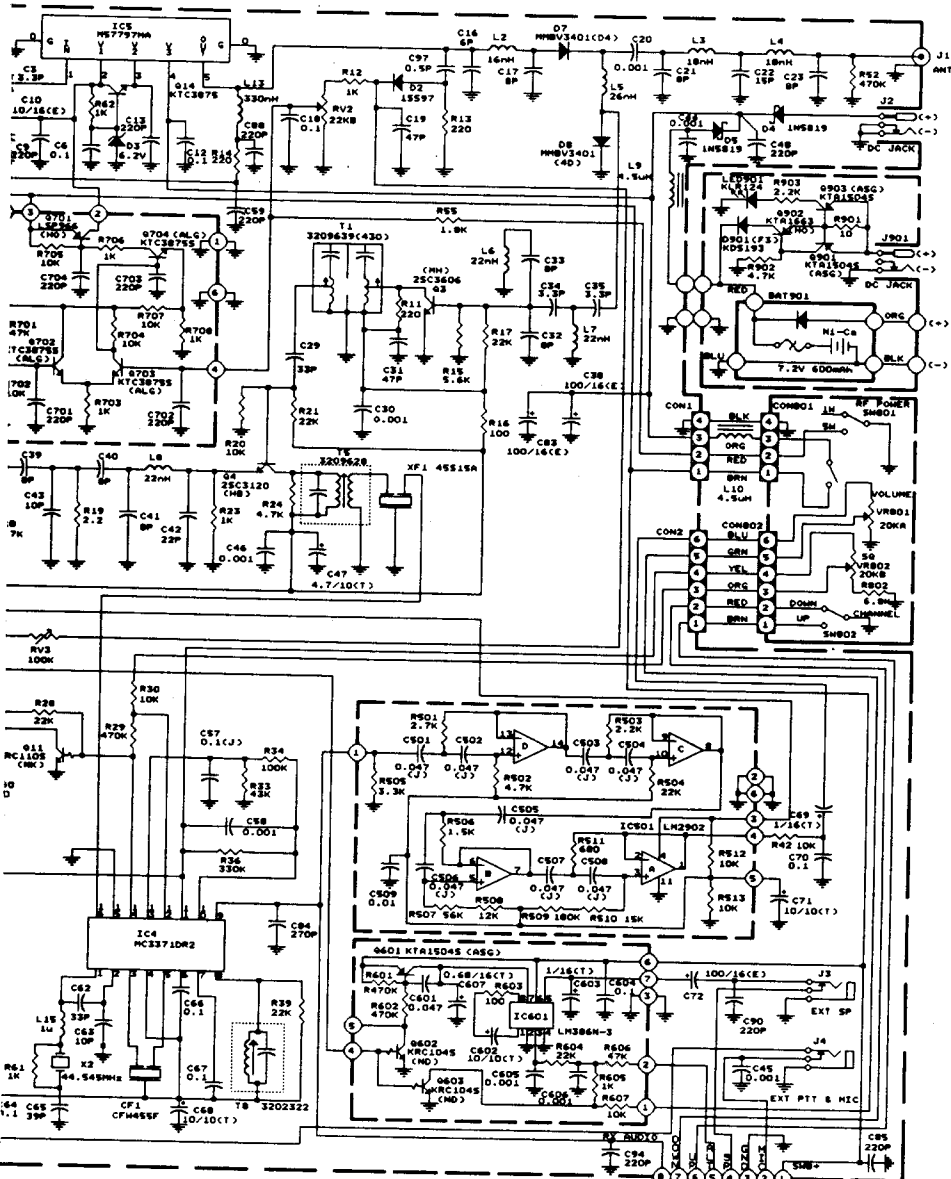

Illustration	Press	Function	Page
T-SQL 1	PTT + 1	Transmit DTMF 1.	35
	F + T-SQL	Tone Squelch.	30
	1	In Standard Memory Mode, first digit of selecting memory 10, 11, or 12.	26
		In VFO mode, enter a frequency. In Priority Memory mode, select Priority Memory 1.	18 25
DTMF 2	PTT + 2	Transmit DTMF 2.	35
	F + DTMF	Store a DTMF sequence.	35
	2	In Standard Memory mode, select Memory 2.	26
		In VFO mode, enter a frequency. In Priority Memory mode, select Priority Memory 2.	18 25
+/- 3	PTT + 3	Transmit DTMF 3.	35
	F + +/-	Duplex offset direction.	20, 21
	3	In Standard Memory mode, select Memory 3.	26
		In VFO mode, enter a frequency. In Priority Memory mode, select Priority Memory 3.	18 25
CA LOCK A	PTT + A	Transmit DTMF A.	35
	F + LOCK	Lock the keypad.	22
	CA	Select the Calling Memory.	24
D-SQL 4	PTT + 4	Transmit DTMF 4.	35
	F + D-SQL	DTMF Squelch.	36
	4	In Standard Memory mode, select memory 4.	26
		In VFO mode, enter a frequency.	18

NOTE: The RF Schematic on Page 43 is in a separate file, scanned at high resolution and expanded to a full page.

Illustration	Press	Function	Page
BEEP 5	PTT + 5	Transmit DTMF 5.	35
	F + BEEP	Turn the key entry beep on and off.	22
	5	In Standard Memory mode, select Memory 5. In VFO mode, enter a frequency.	26 18
REV 6	PTT + 6	Transmit DTMF 6.	35
	F + REV	Reverse the transmit and receive frequencies.	22
	6	In Standard Memory mode, select Memory 6. In VFO mode, enter a frequency.	26 18
P-SC PR B	PTT + B	Transmit DTMF B.	35
	F + P-SC	Priority scan.	25
	PR	Select Priority Memories.	25
SAVE 7	PTT + 7	Transmit DTMF 7.	35
	F + SAVE	Power-save option.	33
	7	In Standard Memory mode, select Memory 7. In VFO mode, enter a frequency.	26 18
M-SET 8	PTT + 8	Transmit DTMF 8.	35
	F + M-SET	In VFO mode, set the memory options. In Standard Memory, Priority Memory, and Calling Memory mode change options for memory channel.	28 23
	8	In Standard Memory mode, select Memory 8. In VFO mode, enter a frequency.	26 18
M-CLR 9	PTT + 9	Transmit DTMF 9.	35
	F + M-CLR	Memory clear.	26
	9	In Standard Memory mode, select Memory 9. In VFO mode, enter a frequency.	26 18

Illustration	Press	Function	Page
M-WR MR C	PTT + C	Transmit DTMF C.	35
	F + M-WR	Memory write.	24 – 26
	MR	Standard Memories.	26
* ▼SC	PTT + *.	Transmit DTMF *.	35
	F + ▼SC	In VFO mode, scan down the selected range.	19
	▼SC	In VFO, Priority Memory, or Standard Memory mode, scan down. In memory set mode, next menu item.	19, 25, 26 23, 28
V-SC 0	PTT + 0	Transmit DTMF 0.	35
	F + V-SC	Vacant channel scan.	19
	0	In Standard Memory mode, first digit to select Memory 01. In VFO mode, enter a frequency.	26 18
# ▲SC	PTT + #	Transmit DTMF #.	35
	F + ▲SC	In VFO mode, scan up the selected range.	19
	▲SC	In VFO, Priority Memory, or Standard Memory mode, scan up. In memory set mode, previous menu item.	19, 25, 26 23, 28
M→VFO VF D CLR	PTT + D	Press D twice to transmit DTMF D. Press once followed by 1 – 5 to send a DTMF sequence.	35 36
	F + M → VFO	Write the current memory channel to the VFO mode.	18, 19
	VF	Select the VFO mode.	18, 19
	CLR	Clear a partially entered frequency.	18

Notes:

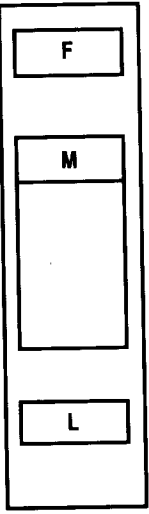
Illustration	Press	Function	Page
	F	Select a key's second function.	
	M	Monitor a channel without squelch. In Standard, Priority, or calling Memory mode, display memory's programmed options.	27
	PTT	Push-to-talk (transmit button).	
	L	Turn on the light for 5 seconds.	17
	F + L	Turn on the light until you press L again to turn it off.	17