

PORTABLE-SCANNER

AM/FM Monitor Receiver

VHF: 30-54/108-136/138-174 MHz

UHF: 380-512 MHz

PRO-30



**OWNER'S
MANUAL**

PLEASE READ BEFORE
USING THIS EQUIPMENT

REALISTIC®

**CAT. NO.
20-131**

CUSTOM MANUFACTURED FOR RADIO SHACK, A DIVISION OF TANDY CORPORATION

CONTENTS

Specifications	4 – 5
A Quick Look At Your PRO-30	6 – 7
Preparation For Use	8
Operating Your PRO-30	9
Receiver Operations Display	9
Searching With Your PRO-30	12 – 13
Error Indications	14
Birdies	14 – 15
Before You Call For Help	16
Some Random Notes	17 – 18
Block Diagram	19

You'll hear all the action with your new **—REALISTIC® PRO-30 Programmable Scanning Receiver!** You'll have direct access to 23,684 different frequencies in nine action radio bands—police, fire, ambulance, aircraft, ham radio, and transportation services! And you can program your PRO-30 to scan up to 16 channels so you won't miss any of the excitement.

The secret to the PRO-30 is a custom-designed microprocessor—a computer on a chip! The front panel keyboard lets you easily enter and change frequencies whenever you wish. The microprocessor also gives you special functions not found on other scanning receivers. Curious about what's on the air in your area? The PRO-30 will automatically search for active stations in frequency ranges of your choice; you can locate new stations and services easily! And if there's a frequency you're especially interested in, the **PRIority** key will make sure you never miss a call on it. You can listen or scan other channels and your PRO-30 will automatically switch to the **PRIORITY** channel when a call is received on it!

Other features you'll appreciate include **Lockout** to skip over channels during scanning and **fast/slow search** and scanning rates.

Your PRO-30 achieves its superior performance through the use of the very latest in solid-state technology. In addition to the microprocessor, the PRO-30 includes a phase-locked loop (PLL) IC, 4 C-MOS ICs including microprocessor, 5 integrated circuits, 39 transistors, 75 diodes and a Liquid Crystal Display.

FEATURES INCLUDE:

- * Covers 30 – 50 MHz (VHF Lo), 50 – 54 MHz (ham radio 6m), 108 – 136 MHz (aircraft), 138 – 144 MHz (government), 144 – 148 MHz (ham radio 2m), 148 – 174 MHz (VHF Hi), 380 – 450 (ham radio and government), 450 – 470 MHz (UHF Lo) and 470 – 512 MHz (UHF Hi) – 23,684 channels!
- * Scan up to 16 channels continuously.
- * Search feature scans frequency ranges for new stations.
- * Priority function means you'll never miss a call on your favorite channel!
- * Large multi-purpose Liquid Crystal Display shows which channels and frequencies are being scanned, monitored or programmed as well as the status of the Channels.
- * Channel Lockout function with built-in skipper circuit.
- * Two-second scan delay function eliminates missed replies.
- * Crystal filter for 1st IF (10.7 MHz) plus ceramic filter for 2nd IF (455 kHz).
- * Battery backup holds memorized frequencies even if the main battery weakens.

RADIO SHACK LIMITED WARRANTY

This product is warranted against defects for 1 year from date of purchase from Radio Shack company-owned stores and authorized Radio Shack franchisees and dealers. Within this period, we will repair it without charge for parts and labor. Simply **bring your Radio Shack sales slip** as proof of purchase date to any Radio Shack store. Warranty does not cover transportation costs. Nor does it cover a product subjected to misuse or accidental damage.

EXCEPT AS PROVIDED HEREIN, RADIO SHACK MAKES NO WARRANTIES, EXPRESS OR IMPLIED, INCLUDING WARRANTIES OF MERCHANTABILITY AND FITNESS FOR A PARTICULAR PURPOSE. Some states do not permit limitation or exclusion of implied warranties; therefore, the aforesaid limitation(s) or exclusion(s) may not apply to the purchaser.

This warranty gives you specific legal rights and you may also have other rights which vary from state to state.

We Service What We Sell

For your own protection, we urge you to record the serial number of this unit in the space provided. You'll find the serial number on the bottom cabinet of this unit.

Serial Number

SPECIFICATIONS

SEMICONDUCTOR COMPONENTS:	1 LSI Microprocessor system, 1 LSI PLL system, 3 C-MOS ICs, 5 ICs, 39 transistors and 75 diodes.	
RECEIVING SYSTEM:	Superheterodyne with digital synthesizer to receive any of 23,684 programmable frequencies.	
FREQUENCY COVERAGE:	VHF-Lo 30 – 50 MHz (in 5 kHz steps) Ham 50 – 54 MHz (in 5 kHz steps) Aircraft 108 – 136 MHz (in 25 kHz steps) Government 138 – 144 MHz (in 5 kHz steps) Ham 144 – 148 MHz (in 5 kHz steps) VHF-Hi 148 – 174 MHz (in 5 kHz steps) Ham/Gov't. 380 – 450 MHz (in 12.5 kHz steps) UHF-Lo 450 – 470 MHz (in 12.5 kHz steps) UHF-Hi ("T") 470 – 512 MHz (in 12.5 kHz steps)	
CHANNELS OF OPERATION:	Any 16 channels in any band combinations.	
SENSITIVITY		
AM: 20 dB Signal-to-Noise ratio at 60% modulation:	108 – 136 MHz	2.0 μ V
FM: 20 dB Signal-to-Noise ratio at 3 kHz Deviation:	30 – 54 MHz	0.5 μ V
	138 – 174 MHz	1.0 μ V
	380 – 512 MHz	1.0 μ V

SPURIOUS REJECTION:	30 – 54 MHz	50 dB at 40 MHz
	108 – 136 MHz	50 dB at 120 MHz
	138 – 174 MHz	50 dB at 150 MHz
	380 – 512 MHz	Not specified.
SELECTIVITY:	±9 kHz, –6 dB	
	±15 kHz, –50 dB	
IF REJECTION:	10.7 MHz	50 dB at 154 MHz
SCANNING RATE:	Fast	10 channels/sec.
	Slow	5 channels/sec.
SEARCH RATE:	Fast	10 steps/sec.
	Slow	5 steps/sec.
PRIORITY SAMPLING:	2 seconds	
DELAY TIME:	2 seconds	
MODULATION ACCEPTANCE:	±7 kHz	
IF FREQUENCIES	10.7 MHz and 455 kHz	
FILTERS:	1 crystal filter, 1 ceramic filter	
SQUELCH SENSITIVITY:	Threshold	Less than 1.0 μ V
	Tight	(S+N)/N 15 dB
ANTENNA IMPEDANCE:	50 ohms	
AUDIO POWER:	220mW maximum	
BUILT-IN SPEAKER:	2" (5cm) 16 ohm, dynamic type	
POWER REQUIREMENTS:	+9V DC, 6 AA batteries, or a suitable adapter (negative ground only)	
	Current drain:	
	55 mA (Squelched)	
	100 mA (full volume unsquelched)	
	3 Silver oxide batteries for Memory back-up	
DIMENSIONS:	190(7 1/2") x 74(2 15/16") x 46(1 13/16")mm HWD	
WEIGHT:	1.04 lbs 480g	

A QUICK LOOK AT YOUR PRO-30

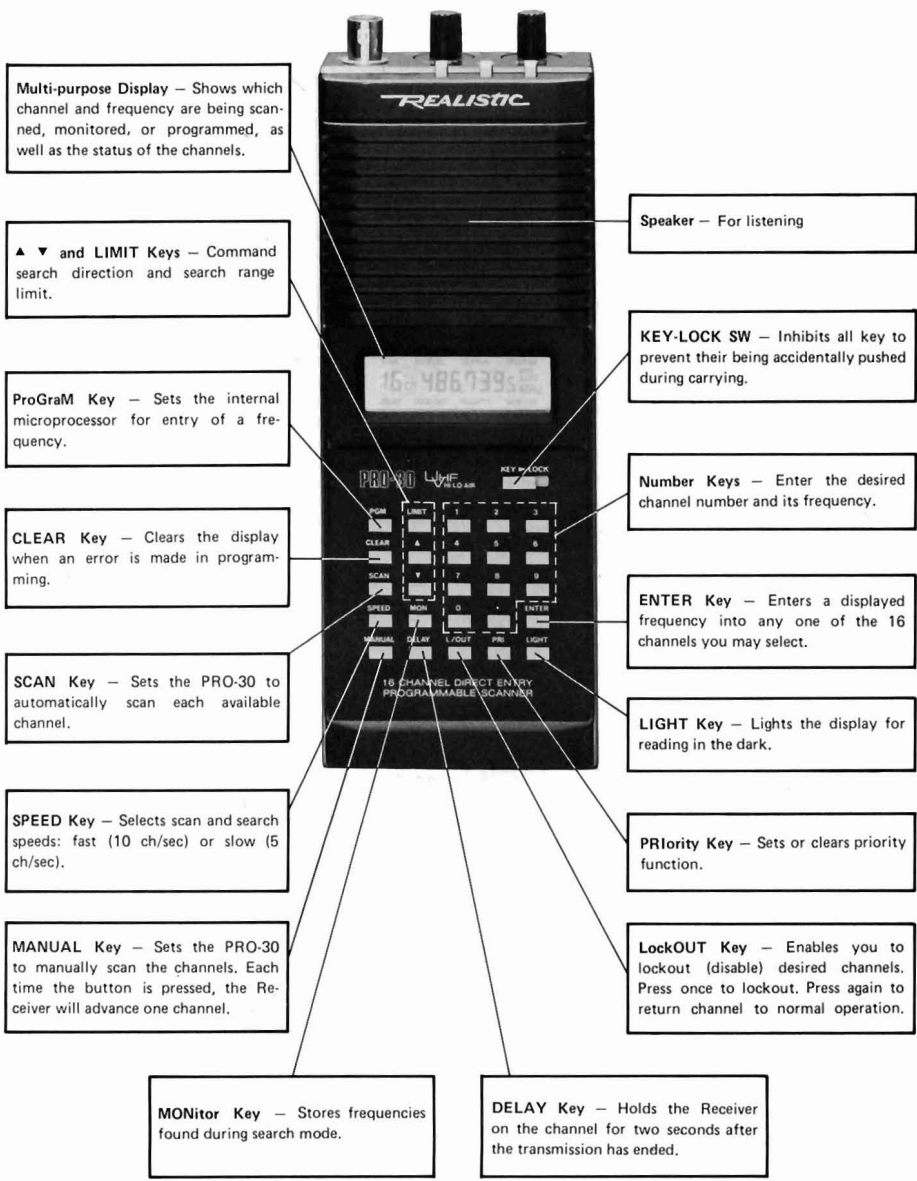

SQUELCH Control — Eliminates background noise between transmissions. With no signal, turn clockwise until noise disappears.

OFF/VOLUME Control — Turn clockwise for power ON. Further rotation will increase volume.

EARphone Jack — For connecting an EARphone. The built-in speaker is automatically disconnected.

ANTENNA Jack — Connect the flexible antenna (supplied) to this jack.

REMOTE KEYS

SPEED Key — Selects scan and search speeds: fast (10 ch/sec) or slow (5 ch/sec).

SCAN Key — Sets the PRO-30 to automatically scan each available channel.

MANUAL Key — Sets the PRO-30 to manually scan the channels. Each time the button is pressed, the Receiver will advance one channel.

External Power (PWR) Jack

Recharger (CHG) Jack

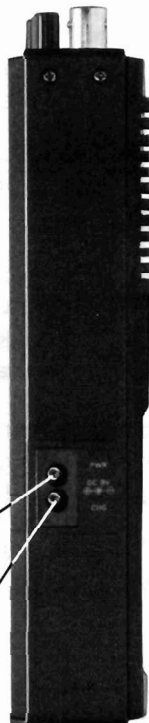

The **Battery Compartment** holds the internal power source (6 type AA batteries plus three silver oxide batteries for memory back-up).

External PoWeR Jack lets you connect an external source of 9 volts DC (negative ground) for operation without batteries. Use our 273-1455 for 120VAC, 14-844D for 12V Car operation. Mobile use of scanners in some areas may be unlawful or require a permit. Check with local authorities.

To recharge Nickel Cadmium batteries in the receiver, simply plug an external 9 volt DC power source (Such as our 273-1455 noted above) into the CHArGe JACK. To fully charge Nickel Cadmiums, leave connected for 10–18 hours.

WARNING

The recharge (CHArGe) jack is to be used only when Nickel-Cadmium batteries are installed in the receiver. Also, do not attempt to operate the unit while recharging Nickel Cadmiums.

PREPARATION FOR USE

To install the batteries, position the Receiver as illustrated, press in the  mark, and slide the battery compartment cover off. Take out the battery holder for AA cells. On the bottom of the compartment is a cover for back-up battery compartment. Slide to open.

Insert three back-up batteries (Catalog Number 23-101 or equivalent) with flat — side toward bottom and push the reset switch (inside battery compartment). Replace the back-up battery cover.

Insert 6 fresh AA batteries into the battery holder, making sure the polarity markings inside the holder match up (+ to + and — to —) with markings on the batteries. Replace the battery holder and the battery compartment cover.

We recommend that you use rechargeable Nickel-Cadmium AA batteries, Catalog Number 23-125, or AA Alkaline ENERCELLs, Catalog Number 23-552.

LOW BATT indicator flickers and sounds an alarm when the battery is low. Replace or recharge batteries. Memory back-up batteries should be replaced once a year.

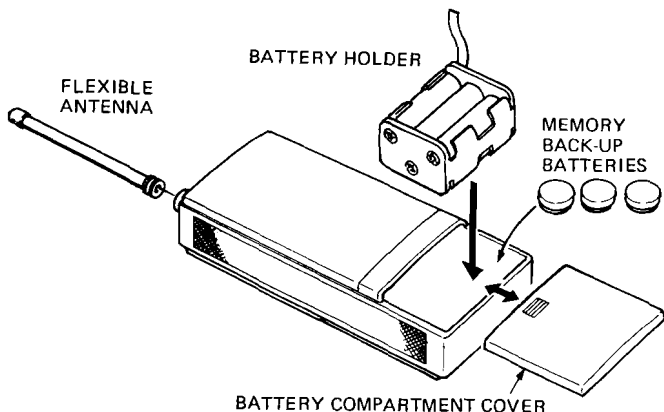

If you wish to use your PRO-30 with an external antenna such as a mobile antenna or outdoor base antenna, remove the flexible antenna and you can connect it to the BNC connector on the PRO-30.

Pressing the reset button located in the battery compartment will clear all frequencies from the scanner memory.

Press this button, using a pen or pencil, before using the scanner for the first time.

OPERATING YOUR PRO-30

Turn on your PRO-30 by rotating VOLUME clockwise. (When first turned on, your PRO-30 might start scanning.)

Rotate SQUELCH fully counterclockwise. You'll hear a rushing noise from the speaker. Slowly rotate SQUELCH clockwise until the noise just stops. You're now ready to start entering frequencies!

Understanding the Display

The liquid crystal display on your PRO-30 can display the channel number, the frequency being received, and the status of different functions. Here's a brief rundown on what those symbols mean when receiving stations.

Receiver Operations Display

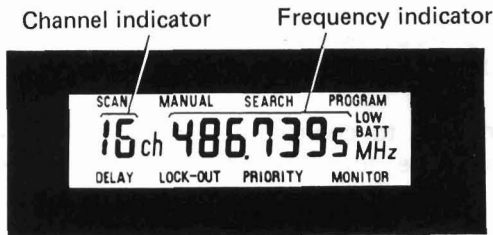

All channels are locked out

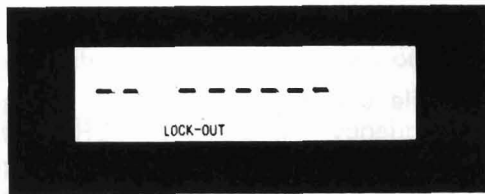

Error indicator

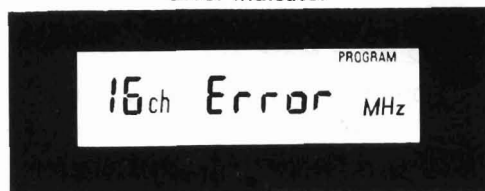

Programming Frequencies

Before programming frequencies, make sure your PRO-30 is turned on and the SQUELCH is adjusted as we described earlier.

Suppose you want to program channel 1 to receive 162.55 MHz. Here's how you would do it:

1. Be sure the KEY-LOCK switch is in the KEY (unlock) position.
2. Press **MANUAL** and select channel 1. You can do this in two ways: press **MANUAL** continuously until the display indicates channel 1 or by pressing **1** **MANUAL**.
3. Press **PGM**.
4. Press **1** **6** **2** **•** **5** **5**. Check the display to make sure the frequency it shows is the one you meant to program. If it is, press **ENTER**.
5. To add more frequencies, press **PGM** to advance to the next channel and follow the steps above.
6. If you ever want to change the frequency entered for a specific channel, enter the new frequency over the old one, using steps 2, 3, and 4.
7. If you want, set the KEY-LOCK switch to LOCK. This inhibits all keys to prevent their being pushed accidentally.

Make a mistake while entering a frequency? Just press **CLEAR**, enter the correct frequency, and press **ENTER**. If you're entering a new frequency in place of an old one, the old frequency won't be erased when you press **CLEAR**. It will remain stored on that channel until you correctly enter a new frequency and press **ENTER**.

You'll hear a beep sound as you press the various keys. This lets you know the key has been properly entered into your PRO-30.

Using the Scanning Function

Your PRO-30 will automatically scan all the channels you've programmed and stop whenever it finds a signal. To scan channels, press **SCAN**.

To stop scanning, press **MANUAL**; then you can select specific channels you want to listen to.

Important! Your PRO-30 won't scan unless SQUELCH is set to the point where no sound is heard if a signal isn't being received.

Delay Function

When your PRO-30 is scanning, it will stop whenever it finds a signal on a channel. As soon as the signal ends, the scanning function will resume. Most communications heard will be two-way. To make sure you don't miss any replies, press **DELAY**. This will cause your PRO-30 to stay on a channel for two seconds after the end of a transmission, giving you time to hear any reply. To release the delay function, press **DELAY** again. The delay indicator will show on the display when the delay function is used.

Lockout Function

You might want your PRO-30 to skip over certain frequencies while it's scanning (such as continuously transmitted weather broadcasts). To lock out such channels, follow these steps:

1. Press **MANUAL** to stop scanning. Continue to press **MANUAL** to advance to the channel you want to lock out.
2. When you reach the channel, press **L/OUT**. The display will show LOCK-OUT, to indicate that this channel will be skipped over during scanning.
3. To release the lockout function, press **MANUAL** to stop scanning. Advance to channel that is locked out and press **L/OUT** again. LOCK-OUT will disappear from the display.

If you use the lockout function on all channels, scanning will be impossible—you'll only be able to change channels using **MANUAL**.

SPEED Selection

Your PRO-30 will normally scan channels at a rate of 5 channels per second. If you press **[SPEED]**, channels will be scanned at a rate of 10 per second. Press **[SPEED]** again to return to a rate of 5 channels per second.

Priority Function

You might want to scan other channels yet not miss a call on a channel of particular interest to you (police, fire, ambulance, etc.). The priority function will let you scan other channels — but if a call is received on the priority channel, your PRO-30 will automatically switch to the priority channel!

1. Only channel 1 can be set as the priority channel: key the desired priority frequency into channel 1.
2. The priority function works only when the unit is in the scan or manual mode.
3. Press **[PRI]** to start the priority function. A PRIORITY will appear on the display.
4. Press **[MANUAL]** or **[SCAN]** to listen to other channels. Your PRO-30 will check the priority channel and switch to it if a signal is received on it.
5. To cancel priority function, press **[PRI]** again. The PRIORITY will disappear from the display.

Searching with Your PRO-30

One great feature of your PRO-30 is its ability to “search” for frequencies being used. This means you can hear all the action on the airwaves in your area! To use this feature, just follow these steps:

1. Press **[PG M]**.
2. Press **[LIMIT]**. Enter the lower limit of the frequency range to be searched (such as 45.00 MHz). Press **[ENTER]**.
3. Press **[LIMIT]** again. Enter the upper limit of the frequency range to be searched (such as 46.00 MHz). Press **[ENTER]**.

4. Press either **▲** or **▼** to start search. **▼** will start search from highest frequency and go down, while **▲** will start from the lowest frequency and go up.
5. You can control the speed of the Search by using **SPEED** the same way you use it during scanning.
6. Search will stop when a signal is detected. To restart search, press **▲** or **▼**.

In the program mode, the search range will be displayed each time **LIMIT** is pressed. It is impossible to change the lower frequency only: to change the lower frequency you must change the higher frequency first. The higher frequency can be changed any time.

Storing Frequencies

If you want to enter some of the frequencies found during search, do this:

1. Press **MON** when your PRO-30 finds a frequency you want to store.
2. Use **MANUAL** to select a channel to enter the frequency your PRO-30 found. The display will show the frequency currently stored on the channel, but don't worry – the old frequency will be erased when you start to enter the new one.
3. Press **PGM**.
4. Press **MON** again. The new frequency found during the search will be displayed.
5. Press **ENTER** to put the new frequency into the channel in place of the old frequency.
6. Press either **▲** or **▼** to resume the search. To return to manual or program operation, press **MANUAL** or **PGM**.
To resume the search from one of the limit frequencies, press **LIMIT** and then **▲** or **▼**.

Display Light

Push **LIGHT** to read the display in the dark.

Low Battery Alarm

LOW BATT indicator flickers and gives off an alarm sound when the battery is low. Replace or recharge batteries.

Key-Lock Function

When the switch is turned to LOCK the main keyboard is inoperative: only the remote keys are operative. When the switch is turned to KEY, both main and remote keys are operative.

Error Indications

Sometimes when you try to enter a frequency for a channel or as a Search range limit, you will find an error on the display. This means the frequency is in error and you won't be able to enter it into your PRO-30.

Such frequency errors usually mean you've entered a frequency outside the ranges your PRO-30 operates on (such as 225.00 MHz) or you've put the decimal point in the wrong place (14.682 MHz instead of 146.82 MHz). Check carefully to find your mistake and then press **CLEAR**. You can now enter the correct frequency.

Birdies

Some frequencies may be difficult or impossible to receive. If you program-in one of these, the Scanner might lock up and you'll hear only noise. These "birdies" are the products of internally generated signals mixing with external signals like TV and FM broadcasts.

If the interference is not severe, you might be able to use SQUELCH to cut out such annoying birdies.

A few of the most common birdies to watch out for are listed below.

30.080 MHz	39.040 MHz	126.275 MHz
30.720	39.680	147.620
30.735	40.070	147.660
31.360	40.320	147.665
32.000	40.540	147.670
32.640	40.980	147.675
33.280	41.600	147.680
33.920	43.520	147.685
34.560	44.800	147.690
35.200	45.440	147.695
36.480	48.000	
37.120	50.315	171.250
37.760	51.200	
38.400	51.225	421.4875

Even with the SQUELCH control set to maximum, scanning or searching may stop on or around some of the frequencies listed above. If the spurious signal is strong enough (above 10 μ V in technical terms) you can listen to it, but the receiver will not auto scan/search.

Earphone Listening

If you're in a noisy area or you don't want to bother other people, plug an earphone in to the EARphone jack. Use our Cat. No. 33-174. This will automatically disconnect the built-in speaker.

In case you're wondering . . .

. . . the tuning range of your PRO-30 is permanently stored in the microprocessor chip. There's no way it can be extended or altered – even by a skilled electronics technician. So if you try to enter a frequency not in the PRO-30's tuning ranges, you'll get an error message every time!

BEFORE YOU CALL FOR HELP

The PRO-30 is a ruggedly built electronic unit, with all parts conservatively rated. However, you should treat it with care; don't subject it to excessively rough handling. You will find it will give you long life if kept free from dirt and excessive humidity.

Three silver oxide batteries (used to maintain the program memory) should be replaced once a year. The frequencies stored in the scanner memory can be held for a few minutes without back-up batteries. Check the memory contents after replacing batteries, and if the memory has been lost, press the reset button and re-enter frequencies.

If you Have Problems

We hope you don't — but if you do, here are some suggestions.

If your PRO-30 locks up or you want to completely clear all memories, remove battery cover and press the reset button with a pen or pencil.

Problem	Possible Cause
Inoperative	No power — check to see that batteries are good and are properly installed.
Will not scan	1) All channels are locked out. 2) Squelch control is not adjusted correctly.
Scan locks-in on frequencies where no clear signal is present	"Birdies" — see list on page 15

If none of these suggested remedies solves the problem, return your set to your nearby Radio Shack for repair by a qualified technician.

BLOCK DIAGRAM

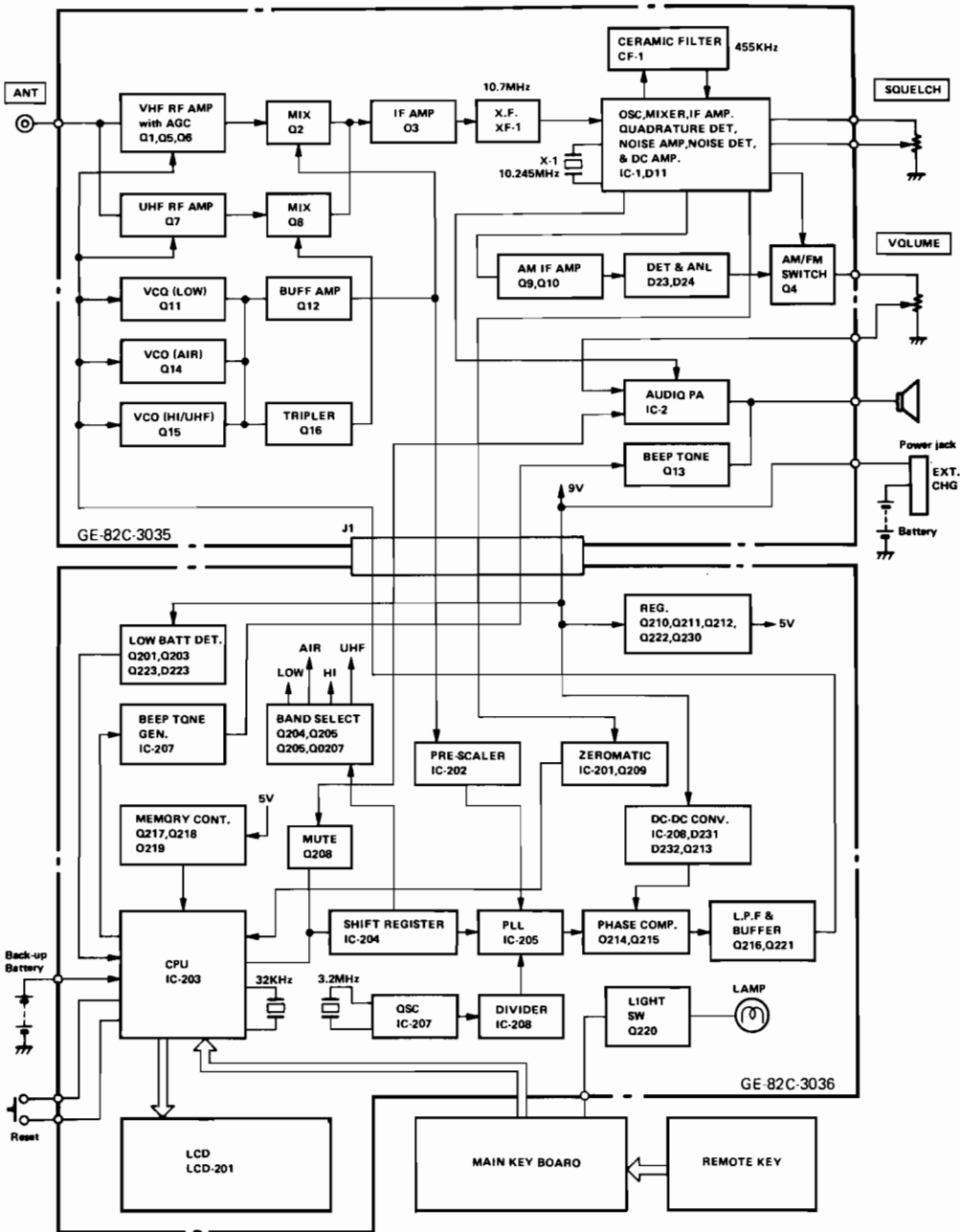

U.S. PATENT NOS.

3,794,925

3,801,914

3,961,261

3,962,644

4,027,251

4,092,594

4,123,715

4,245,348

RADIO SHACK, A DIVISION OF TANDY CORPORATION

U.S.A.: FORT WORTH, TEXAS 76102

CANADA: BARRIE, ONTARIO L4M 4W5

TANDY CORPORATION

AUSTRALIA

91 KURRAJONG ROAD
MOUNT DRUITT, N. S. W. 2770

BELGIUM

PARC INDUSTRIEL DE NANINNE
5140 NANINNE

U. K.

BILSTON ROAD WEDNESBURY
WEST MIDLANDS WS10 7JN