

SR **STANDARD.**



144/430 MHz FM Twin-Band Handy Transceiver

C528

OWNER'S MANUAL

Congratulation on your purchase of the 144/430 MHz FM twin-Band Handy Transceiver. The model C528 FM Twin-Band Handy Transceiver is engineered and manufactured with highest quality of microelectronics technology and workmanship. We are confident that you will be entirely satisfied with the superb performance and reliability of the C528.

Our very strict quality control and inspections ensure that each transceiver unit have left the factory in perfect condition. However, if your transceiver does not operate properly or if you find any difficulty in its operation, please contact your dealer immediately.

Please read this instruction carefully before use to make the unit perform fully and last long. Also please retain this booklet for future reference.

CONTENTS

Packaging Diagram	1
Prior to Usage	1
Controls and Connections	4
Before Operation	11
(1) Basic Functions of the C528	11
(2) Button Function List (I)	15
(3) Button Function List (II) (in Set Mode)	17
Repeater Operation	18
Repeater Operation Method	19
Hiding One of the Band Displays	23
Dual-Watch for Watching a Frequently-Used Frequency and the Repeater Station Frequency Alternately	24
Other Operations	26
(1) Memory Frequencies	26
(2) Programming a Memory Frequency	26
(3) Recalling a Memory Frequency	27
(4) Changing a Memory Frequency	27
(5) Deleting a Memory Frequency	28
(6) Scanning [C MS MS.M Button]	29
(7) Switching the Transmit Power [3/PO Button]	34
(8) Dual-Watch Operation [2/DUAL Button]	35
(9) Changing the Tuning Step [6/STEP Button]	37
(10) Battery-Save Function [5/SAVE Button]	38
(11) Frequency Lock Function [4/FL Button]	38
(12) PTT Lock Function for Disabling PTT Button Operation [1/PL Button]	39

(13) Switching Pause Scan/Busy Scan [0/SET SB Button]	39
(14) Tone Squelch Function [7/T.SQ Button]	40
(15) Special Functions Available in the Set Mode [0/SET SB Button]	41
(16) Changing Frequency During Memory Recall Mode to Initiate New Communication, and Returning to Memory Recall Mode Again	45
(17) Writing the Repeater Mode in a Memory Frequency	46
(18) Changing Repeater Mode Tone Frequency or Offset Frequency Written in a Memory Frequency	46
(19) Writing the Tone Squelch Mode in a Memory Frequency	47
(20) Canceling the Repeater Mode of a Memory Frequency	47

Paging Function

(1) Preparation for Paging Operation	48
(2) Programming the Individual Code and Group Code in Memory	49
(3) Paging Operation Method	51
(4) Code Squelch Operation	54

Lithium Battery	54
Troubleshooting	55
Optional Accessories	57
Specifications	58

PACKAGING DIAGRAM

PRIOR TO USAGE

When unpacking the unit carton, check that all of the following items are included. If some items are missing, please notify your dealer immediately.

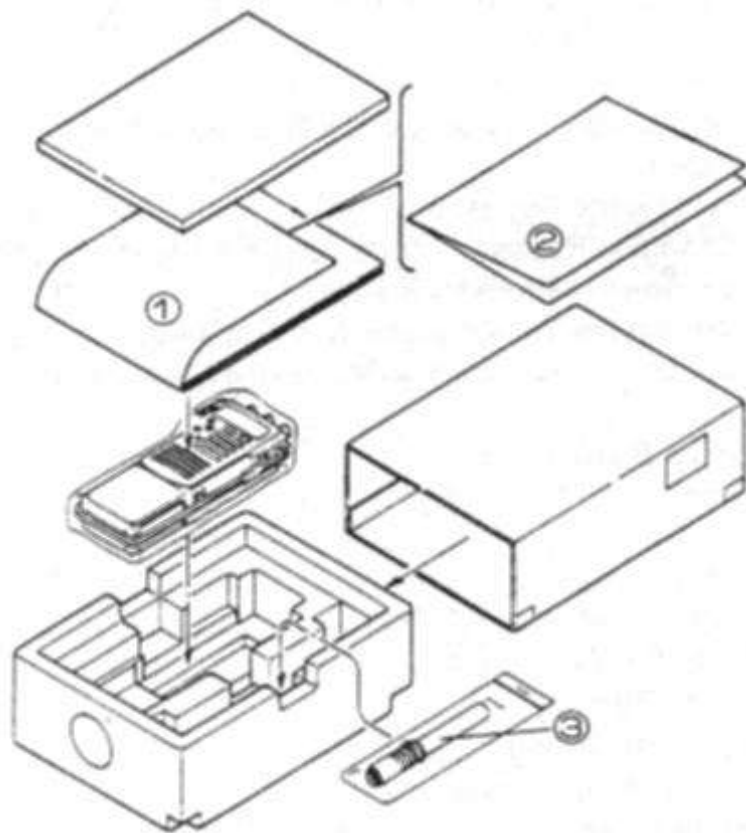

Package Contents

- ① Owner's Manual
- ② Schematic Diagram
- ③ Whip Antenna
- ④ Belt Clip (with two screws)
(already installed on the unit)
- ⑤ Hand Strap (already installed on the unit)
- ⑥ Battery Case (for six AA-size batteries)
(already installed on the unit)
- ⑦ Waterproof Caps (already installed on the unit)

Observe the following caution to protect the unit.

- 1 Make sure that batteries are inserted with correct polarity (+, -).

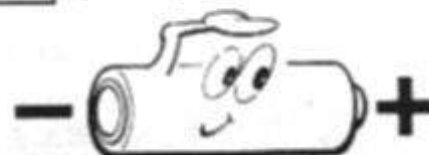

- 2 Do not touch the internal cores and trimmers. The C528 is produced under strict control and fully adjusted.



- 3 Keep out of high temperature, humidity and dust.



- 4 Do not apply 24 V supply to the unit. Use only 6.0 to 16 V DC power supply.



- 5 Do not use new and used batteries together.

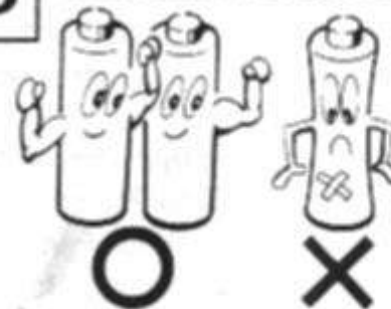

- 6 Do not dispose a battery in fire.



2 Getting ready

1

Install the supplied antenna. Hold the lower part of the antenna when installing.

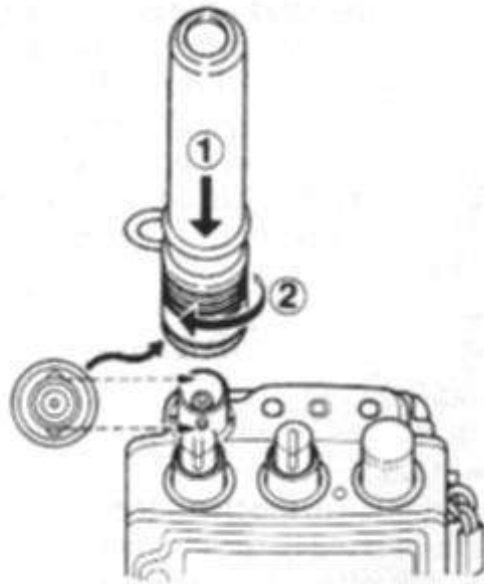

2

Detach the battery case.

(a) Place your thumb on the center of the Battery Case Unlock button, and place the index finger on the battery case side.

(b) Push up the Battery Case Unlock button in the direction of the arrow ① and slide the battery case in the direction of the arrow ② to unlock.

(c) Slide the battery case further until it is separated from the unit.



3

Insert AA size batteries into the battery case. Be sure that the batteries are inserted with correct polarity.

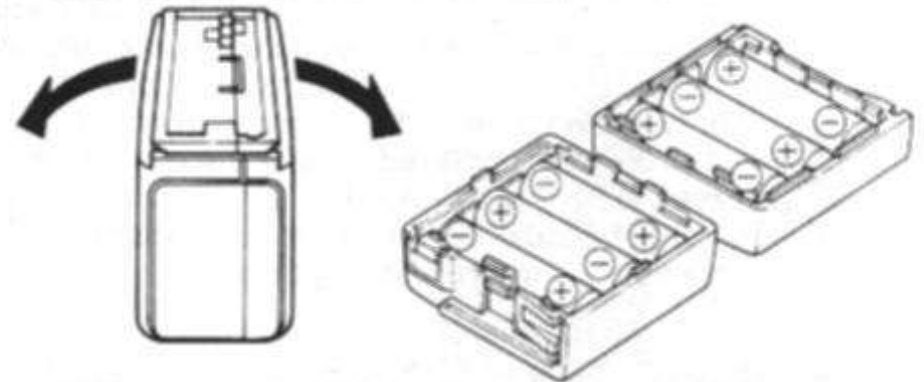

4

Re-install the filled battery case to the transceiver unit.



To install the battery case, engage it with the slot on the bottom of the transceiver and slide the battery case until it latches in the proper position.

5

Turn the Power switch on and set the Volume control to a comfortable listening level.

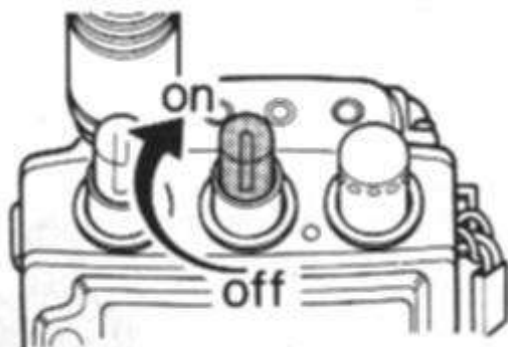

6

Rotate the SQL (Squelch) control clockwise slowly until the noise from the speaker just stops.

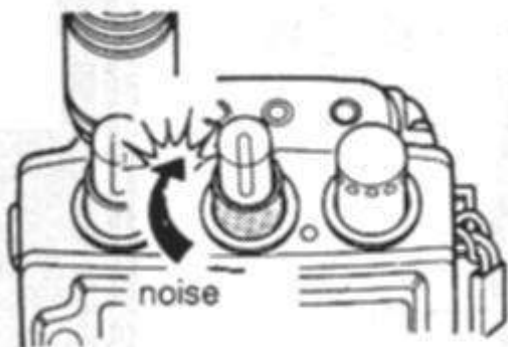

NOTE:

Do not rotate the control clockwise too far. Excessive squelch reduces the radio sensitivity and may prevent reception.

** The supplied antenna and battery case may vary depending on the destination of the set.*

7

Press the PTT button to transmit and release it to receive.



CONTROLS AND CONNECTIONS

* The supplied antenna and battery case may vary depending on the destination of the set.

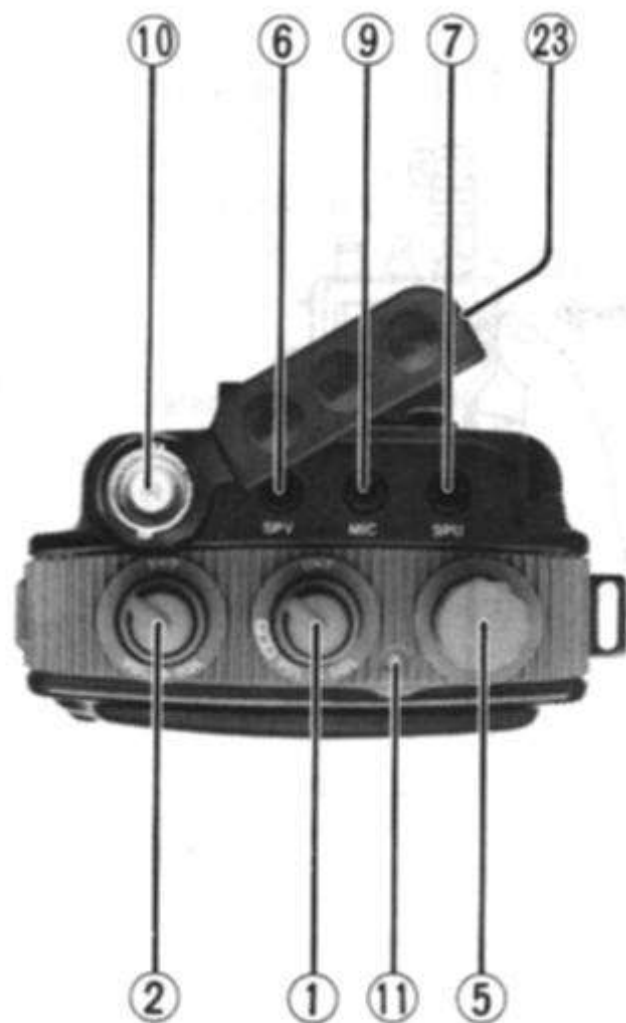

Top Panel Controls and Indicators

① Power On-Off Switch/UHF Band Volume Control

This is to turn the power on and off and to control the listening volume of the UHF band.

When the control is rotated clockwise, it clicks and the power is turned on. Rotating the control clockwise further increases the volume, and rotating it counterclockwise until it clicks turns the power off.

When the Power switch is turned on for the first time after unpacking, [146.000] and [433.000] are displayed. Rotate the control clockwise further to increase the UHF band volume.

The UHF SQL control should be set to the fully counterclockwise position when controlling the UHF band volume.

② VHF Band Volume Control

The VHF SQL control should be set to the fully counterclockwise position when controlling the speaker volume.

③ UHF SQL Control

This is the Squelch control for the UHF band.

The SQL control is used to eliminate the white noise proper to FM reception. First, rotate the control counterclockwise so that white noise is heard (the control has been set to the fully counterclockwise position when the unit left the factory). Then, rotate the control clockwise slowly and set it where the noise just stops.

④ VHF SQL Control

This provides the VHF band reception with the same function as the UHF SQL control.

NOTES:

1. Do not rotate the SQL controls clockwise too far, for this will prevent reception of weak signals.
2. The control should be placed where the white noise is not heard during following operations; Scanning, Dual-Watch, Battery-Save, Paging, Code Squelch.
3. Adjust the SQL controls with the channel which is not receiving the signal.

⑤ Rotary Channel Selector

This is to vary the TX (transmit) and RX (receive) frequency.

The interval by which the frequency changes (channel step) has been set to 5 kHz.

In addition to the frequency variation, the Rotary Channel Selector can also be used to recall a memory address No., recall a tone frequency, set the offset frequency, recall a paging address No. during paging operation, and to change the tuning step. Rotate the Rotary Channel Selector clockwise to increase the TX/RX frequency, and counterclockwise to decrease it. In other cases than the frequency selection, rotating the knob clockwise increases the displayed figure and rotating the knob counterclockwise decreases it.

The TX/RX frequencies can be set independently for the VHF and UHF band.

It is also possible to vary the Sub-band frequency while receiving in the Main band.

When the Rotary Channel Selector is rotated with the FUNC button held depressed, the frequency varies in 100-kHz steps.

⑥ SPV (VHF Band External Speaker) Jack

Connect an external speaker.

When an external speaker is connected, the speaker outputs sound in both VHF band and UHF band operations, and the built-in speaker is disabled.

Use a Microphone/Speaker (CMP111 or CMP112) or Head Set with PTT (CHP111), which are available as options.

⑦ SPU (UHF Band External Speaker) Jack

Connect an external speaker.

When an external speaker is connected, the speaker outputs sound only in UHF band operation, and the built-in speaker outputs sound only in VHF band operation.

Advice

Jacks Used	External Speaker	Built-in Speaker
SPV only	UHF/VHF	X
SPU only	UHF	VHF
Both SPV/SPU	UHF-VHF	X

⑧ Built-in Speaker

This outputs the received contents and buzzer sound.

This is used both in VHF band and UHF band operations.

⑨ MIC (External Microphone) Jack

This is to connect a microphone which is available as an option.

One of the following options manufactured by STANDARD can be used as the external microphone.

- 1) Microphone/Speaker ... CMP111, CMP112 (compact model)
- 2) Head Set with PTT CHP111
- 3) Tiepin Microphone CMP113

⑩ Antenna Jack

This is to connect the whip antenna.

Be sure to use the supplied or specified whip antenna.

If the connected antenna does not match the characteristics of the transceiver, its performance may be degraded.

⑪ Transmit Indicator, Busy Indicator and Battery Alarm Lamps

The green lamp lights up when signal is received in the VHF band, UHF band or both in the VHF and UHF bands. It also lights up when the SQL control is rotated fully counterclockwise. The red lamp lights up when the transmitter is keyed by pressing the PTT button.

Both the red and green lamps light up in case transmission and reception occur simultaneously during twin operation.

The lamps become darker when the batteries are weakened; in such a case, replace the batteries as soon as possible.

Front Panel Controls and Indicators

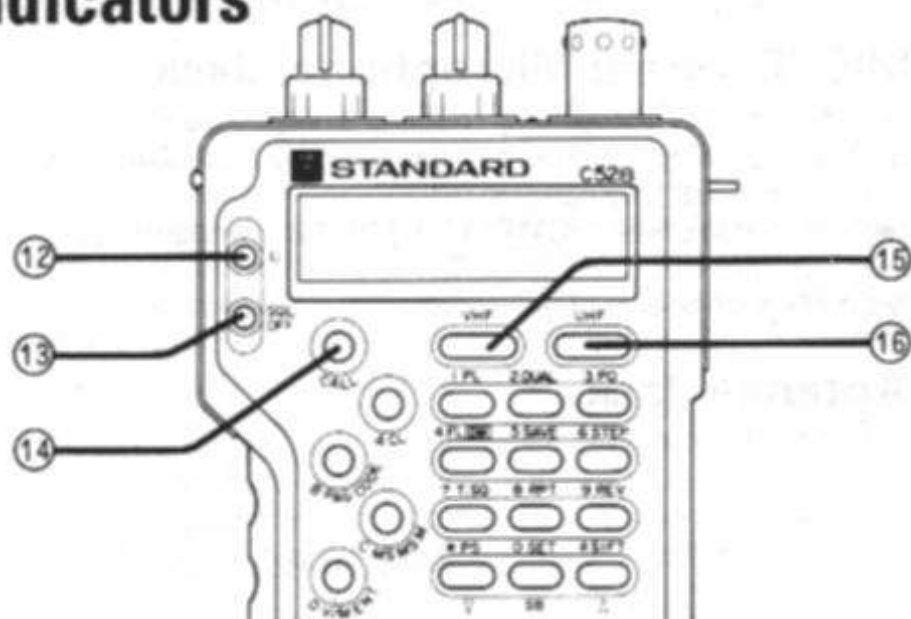

⑫ L (Lamp) Button

This to turn on the illumination light at the display.

When this button is pressed, the display is illuminated for about 5 seconds, after which the illumination light is turned off automatically. The light can also be turned off manually by pressing this button while the light is lit.

To leave the light on, press the L button with the FUNC button held depressed. The light can be turned off by pressing the L button with the FUNC button held depressed.

The L button is effective regardless of the band buttons (VHF button, UHF button). It is recommended not to leave the light on for a long period, for this will hasten the battery exhaust.

⑬ SQL OFF (Squelch Off) Button

While this button is held depressed, the white noise of the Main band is output regardless of the SQL control setting.

When this button is pressed with the FUNC button held depressed, the white noise of the Sub band is output regardless of the SQL control setting (provided that the twin operation is activated).

The SQL OFF button is effective regardless of the band buttons.

When this button is pressed, the received sound can be listened to by turning Noise Squelch, Tone Squelch and Code Squelch off.

The SQL control can turn on-off only the Noise Squelch.

⑭ CALL (Burst) Button

When the CALL button is pressed with the PTT button held depressed, the 1750 Hz tone burst signal will be transmitted only while the CALL button is depressed.

When the CALL button is pressed during reception, a buzzer sound will be generated.

⑮ VHF Button

Press this button for VHF band operation, which is indicated by the "MAIN" indicator lit above the VHF band frequency display.

When this button is pressed with the FUNC button held depressed, the whole of the UHF band display disappears so the unit can be used as a VHF-only (mono-band) transceiver.

With the initial setting (when the unit left the factory or when the unit is reset), the MAIN indicator appears above the VHF band frequency display. The band for which the MAIN indicator is lit is referred to as the Main band, and the band for which the MAIN indicator is not lit is called the Sub band.

⑯ UHF Button

Press this button for UHF band operation, which is indicated by the MAIN indicator lit above the UHF band frequency display.

When this button is pressed with the FUNC button held depressed, the whole of the VHF band display disappears so the unit can be used as a UHF-only (mono-band) transceiver.

NOTE:

Transmission in the VHF band sometimes interferes with the reception in the UHF band. To prevent this, do not use a UHF frequency that is adjacent to the frequency three times the VHF frequency being used.

Example: When the transmit frequency is 145.02 MHz and receive frequency is 435.06 MHz, because $145.02 \times 3 = 435.06$ (MHz)

Display Panel

The display uses an LCD (Liquid Crystal Display) panel and independent VHF band and UHF band frequency displays in order to help the unit be used as a twin-bander transceiver featuring simultaneous twin-watch operation.



Indicators on the display

- ① MAIN Indicates the Main band.
- ② M Indicates the Memory frequency recall mode.
- ③ ▼ Indicates that the address No. of Memory Scan Memory is displayed.
..... In Paging operation, indicates that the group code mark is displayed.
- ④ 0 - 9 Indicates the memory address No. or code address No.
- ⑤ AP Indicates Auto Power Off.
 - H Indicates high power transmission.
 - M Indicates middle power transmission.
 - L Indicates low power transmission
- ⑦ S Indicates Battery-Save operation.
- ⑧ B Indicates Busy Scan operation.
- ⑨ DUAL Indicates Dual-Watch operation.
- ⑩ + - Indicates the positive or negative Shift frequency direction.
- ⑪ T Indicates Tone Encoder operation.

- ⑪ **TSQ**..... Indicates Tone Squelch operation.
- ⑫ **F.L**..... Indicates Frequency Lock operation.
- ⑬ **P.L**..... Indicates PTT Lock operation.
- ⑭ **14500** Indicates the VHF band frequency (section of [88888] on the left).
- ⑮ **43300**..... Indicates the VHF band frequency (section of [88888] on the right).
- ⑯ **OFF**..... Indicates Off Band (during Repeater operation).
- ⑰ **75, 50, 25** Indicates the figures of 1 kHz and 100 Hz.
- ⑱ **During reception** S (Signal) meter.
- During transmission**..... Indicates the TX output level.
 - P**..... Indicates Paging operation (in place of the figure of 100 MHz).
 - ⑲ **C**..... Indicates Code Squelch operation (in place of the figure of 100 MHz).
 - E**..... Indicates error found in received code in the Code Set mode (in place of the figure of 100 MHz).
 - ⑳ **C**..... Indicates the Code Set mode (in place of the figure of 10 MHz).
 - ㉑ **▶**..... Indicates that the entry of the figure of 1 kHz is possible.

Side Panel Controls

⑰ FUNC (Function) Button

One of the special functions of this unit is available by pressing a button with the FUNC button held depressed.

⑱ PTT Button

For transmission, hold this button depressed and speak into the microphone. The signal is transmitted in the Main band which is indicated by the MAIN indicator. Release the PTT button to receive signal.

⑲ DC IN (External DC Power Input) Connector

This is to connect the power cable in case an external power supply is used.

NOTE:

Connect the plug of the CAW150 or CAW151 External Power Cord that is available as an option. The DC IN connector accepts only the special plug used with the CAW150 or CAW151; never connect other types of plugs for this will result in malfunction or damage. Before connecting the plug of the CAW150 or CAW151, be sure to turn off the power of the transceiver. This unit operates on the voltage range from 6 to 16 V DC; never apply a voltage out of this range, for this will result in malfunction or damage.

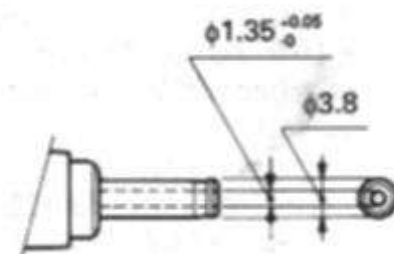
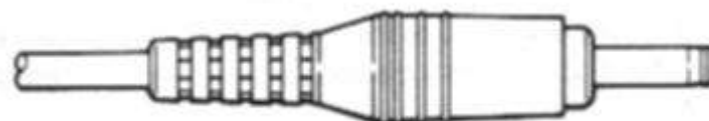

⑳ Battery Case

This accommodates six "AA" size dry cell batteries. Insert six "AA" size batteries with correct polarity.

㉑ Battery Case Unlock Button

Push when detaching the battery case. The battery case will be unlocked and ready for detaching.

㉒ Belt Clip Holes

These holes are to hold the supplied belt clip. The belt clip has been installed when the unit left the factory. When the belt clip is detached, please leave the belt clip retaining screws in these holes.

㉓ Waterproof Caps

When the external microphone or speaker is not used, plug each of their jacks with a waterproof cap.

㉔ Built-in Capacitor Microphone

For transmission without using an external microphone, speak into this microphone.

㉕ Reset Switch

Press to reset the microcomputer inside the unit. After replacing the lithium battery backing up the microcomputer or when the microcomputer malfunctions, push the recess on the center of the rubber plate on the transceiver side panel strongly using a thin stick. The whole of the displayed contents disappear for a moment and the microcomputer is reset to the initial condition. When the microcomputer has been reset, [145.000] and [433.000] appears on the display.

NOTES:

1. *When the microcomputer is reset, all of the programmed contents is cleared.*
2. *If strange contents are displayed every time the power of the transceiver is turned on or off, please replace the lithium backup battery.*
3. *The microcomputer should be reset while the transceiver power is on.*
4. *Do not apply strong shock to the surroundings of the Reset switch, for this could cause the microcomputer to be reset.*

BEFORE OPERATION

1 Basic Functions of the C528

- This unit incorporates independent transceiver functions for the UHF band and VHF band. Also, almost all operations can be used independently for the UHF and VHF bands.
- When the PTT button is pressed (to transmit), the signal is transmitted from the Main band indicated by the MAIN indicator above the band frequency display.
- Some buttons are effective only for the Main band indicated by the MAIN indicator, and some can be used regardless of the presence of the MAIN indicator.



- The VHF stands for "Very High Frequency". It is normally referred to as "144 MHz band" or "2-meter band".

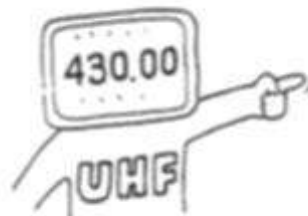

- The UHF stands for "Ultra High Frequency". It is normally referred to as "430 MHz band" or "70-centimeter band".

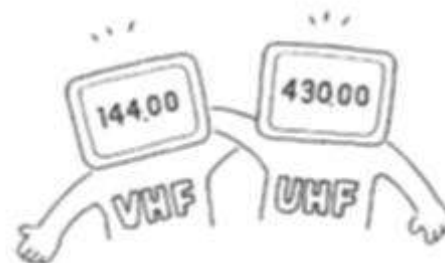

Independent operation



Simultaneous reception OK!!

Character indications on the controls

The characters indicating the functions of the control buttons are marked in three types of colors.

- To use the functions marked with ivory-color characters, press only that button.

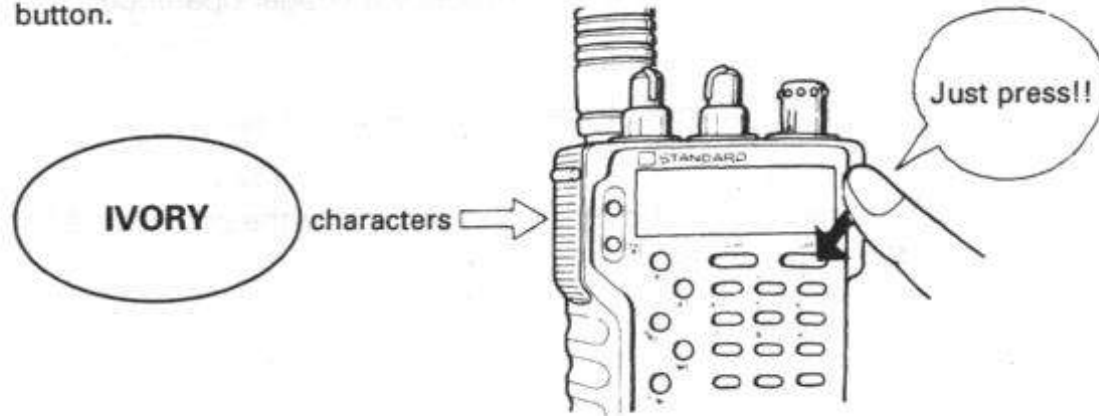

- To use the functions marked with light blue-gray characters, press that button with the FUNC button held depressed.

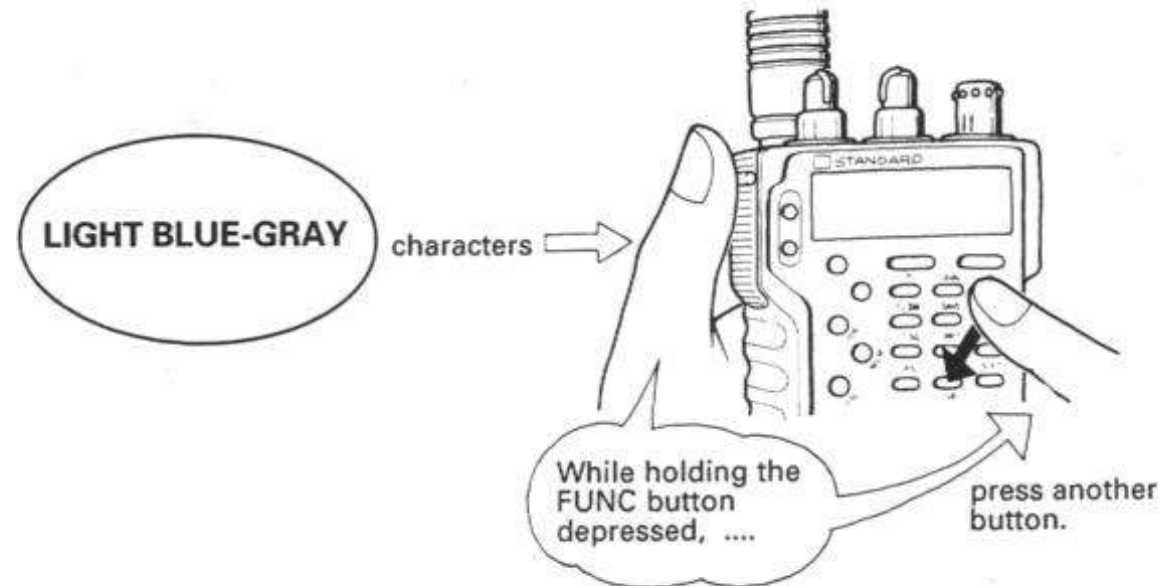

- The functions marked with red characters can be used during DTMF Encoder operation, in combination with the numeric buttons.



Various beep tones

The beep tones are generated to inform the user whether each operation is correct or not.

This unit generates different types of beep tones as follows.

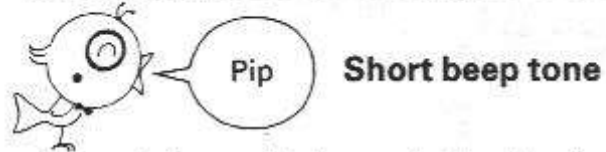

Informs that a control button is operated properly.



Informs that an operation has completed properly
(for example, when a frequency has been programmed in the memory circuit).

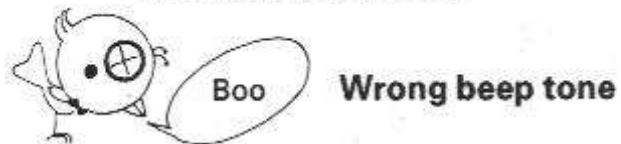

Informs that an operation is improper or when a button operation is invalid.

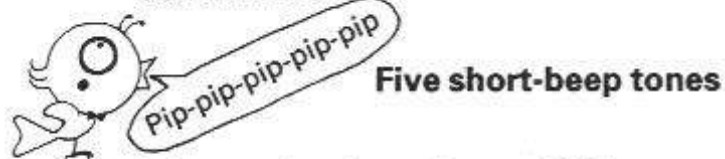

Informs that Auto Power Off is operating or that signal is received during Pager operation.



Informs that signal is transmitted with Pager operation.



Informs that a function is canceled or that the unit returns to the initial setting.

How to set an operating frequency

The operating (TX/RX) frequency shown on the display can be changed as follows.

- ① Setting with numeric buttons on the front panel

Procedure

Example: To set 432.80 MHz

- ① Setting the MHz figure Press numeric button "2".
432. will be displayed.
- ② Setting the 100 kHz figure Press numeric button "8".
432.8 will be displayed.
- ③ Setting the 10 kHz figure Press numeric button "0".
432.80 will be displayed.

When the three numeric buttons are pressed correctly, a long keep tone will be generated informing you that the frequency setting is complete.

While the operating frequency is set using the numeric buttons, the frequency which has been selected before the first numeric button was pressed continues to be received.

- ① Press the numeric buttons.



- ② Setting with the Rotary Channel Selector.

Rotate the Rotary Channel Selector

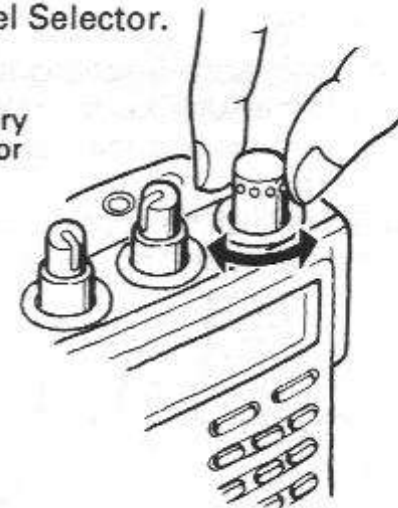

- ③ Setting with the ▼ / ▲ buttons.

Press the ▼ and ▲ buttons.

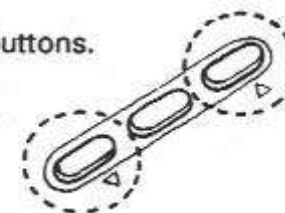

Other functions

- In addition to those functions that can be activated by pressing a button with the FUNC button held depressed, some functions can be activated by initiating the Set mode then pressing a front panel control button.

Examples of such functions include the tone frequency setting and offset frequency setting operations.

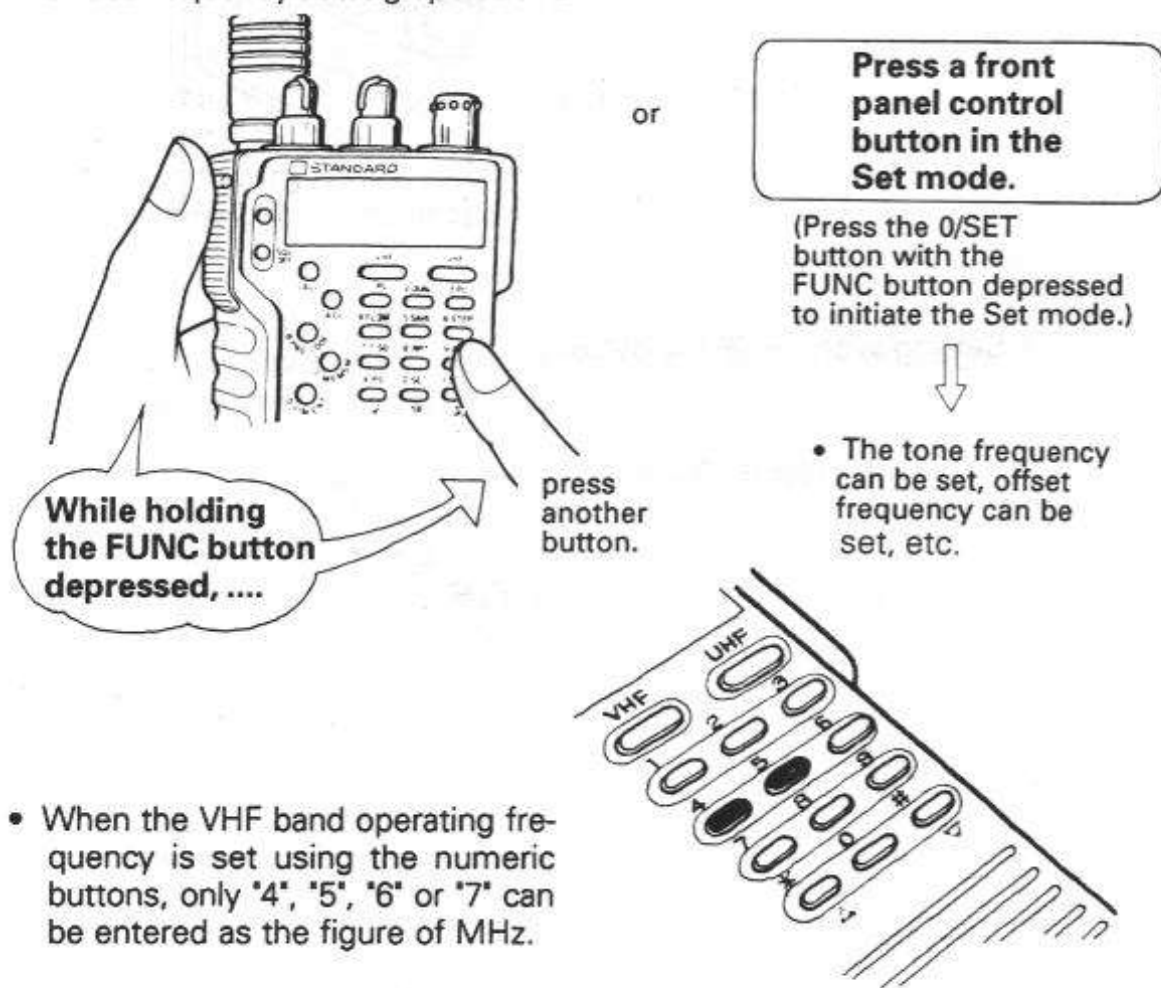

- When the VHF band operating frequency is set using the numeric buttons, only '4', '5', '6' or '7' can be entered as the figure of MHz.

Because the VHF band operating range is only from 144.00 MHz to 145.99 MHz.

2 Button Function List (I)

Button Name	Direct Input Function (when pressed independently without FUNC button held depressed)	Function when pressed with FUNC button held depressed
0 SET SB	Inputs "0". Turns on/off the Busy Scan when pressed in the Scan mode.	Initiates the Set mode.
1 PL	Inputs "1".	Turns on/off the PTT Lock.
2 DUAL	Inputs "2".	Turns on/off the Dual operation.
3 PO	Inputs "3".	Switches the transmission power.
4 FL DM	Inputs "4".	Turns on/off the Frequency Lock. When pressed during code display, turns on/off the decode mark indicator.
5 SAVE	Inputs "5".	Turns on/off the Battery-Save operation.
6 STEP	Inputs "6".	Displays the tuning step. The tuning step itself can be varied with the Rotary Channel Selector.
7 T.SQ	Inputs "7".	Turns on/off the Tone Encoder and Tone Squelch operations.

Button Name	Direct Input Function (when pressed independently without FUNC button held depressed)	Function when pressed with FUNC button held depressed
8 RPT	Inputs "8".	Switches between the Repeater mode and Normal mode.
9 REV	Inputs "9".	Reverses the TX and RX frequencies during Repeater operation.
* PS ▼	Counts the frequency downwards.	Turns on/off the Scan operation. The Scan operation can also be turned off with other buttons. The numeric buttons are defeated during Scan operation.
# SIFT ▲	Counts the frequency upwards.	Initiates the Memory Shift operation.
CALL	Transmits 1750 Hz tone burst signal (no audio modulation is applied) while this button is depressed with the PTT button held depressed.	_____
A CL	Cancels any operation.	_____
B PAG CODE	Turns on/off the Paging and Code Squelch operations.	Displays the code.
C MS MS.M	Turns on/off the Memory Scan operation.	Sets MS.M scan frequency and turns on/off the MS.M operation.

Button Name	Direct Input Function (when pressed independently without FUNC button held depressed)	Function when pressed with FUNC button held depressed
D V/M ENT	Switches between the VFO mode and Memory Frequency mode, or accesses the VFO mode.	Initiates memory entry operation.
VHF	Initiates VHF band operation.	Enables only the VHF band operation.
UHF	Initiates UHF band operation.	Enables only the UHF band operation.
LAMP	Turns on/off the lamp. (Note 1)	Leaves the lamp on. (Note 1)
SQL OFF	Turns off the Squelch operation (to output sound from the speaker). (Note 1)	Turns off the Squelch of the Sub band (only during Twin operation). (Note 1)
PTT	Starts transmission.	_____

Note 1: Also valid in the FL (Frequency Lock) mode.

3 Button Function List (II) (in Set Mode)

Button Name	Function when pressed in the Set Mode
0 SET SB	Turns on/off the beep tones.
1 PL	Changes the count of beep tones generated in Paging operations (single short-beep tone or five short-beep tone).
2 DUAL	Enables the entry of the figure of 1 kHz with a numeric button.
3 PO	Sets the transmission delay time to be used in Repeater operation during Paging operation (450 ms or 750 ms).
4 FL DM	Mutes short noises during Squelch operation. (The current consumption may increase slightly.)
5 SAVE	Turns on/off the APL function.
6 STEP	Enables the Rotary Channel Selector during Frequency Lock.
7 T.SQ	Sets the tone frequency.
8 RPT	Sets the offset frequency.
9 REV	Changes the LAMP button into the REV mode switch.

REPEATER OPERATION

1. Repeater operation

The repeater operation refers to the telecommunications by intermediate of a repeater station.

The repeater operation is possible only in areas where there is a repeater operation. For the TX/RX frequencies of the repeater station, please check a radio magazine, etc.

2. Features of repeater operation

- Signals are transmitted and received using different frequencies and by intermediate of the repeater station. Therefore, the transceiver should be capable of shifting between the TX and RX frequencies. The transceiver should also incorporate the tone encoder which drives the repeater station.
- Since the repeater operation is aided by a repeater station, even a small-power transceiver can be used to communicate with a very remote station. With the repeater operation, it is recommended to use low-power output, because several repeater stations using the same receive frequency would be accessed in case the high-power output is used.
- When to use the continuous tone signal optional, CTN520 should be installed.

Conventional operation (in case of 430 MHz band)

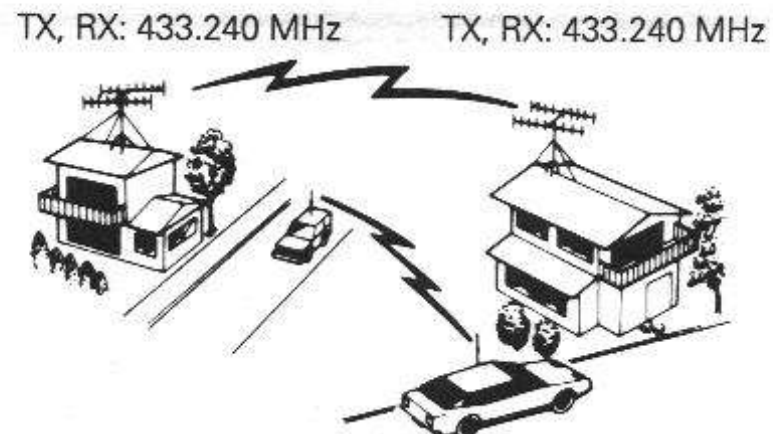

Repeater operation (in case of 430 MHz band)

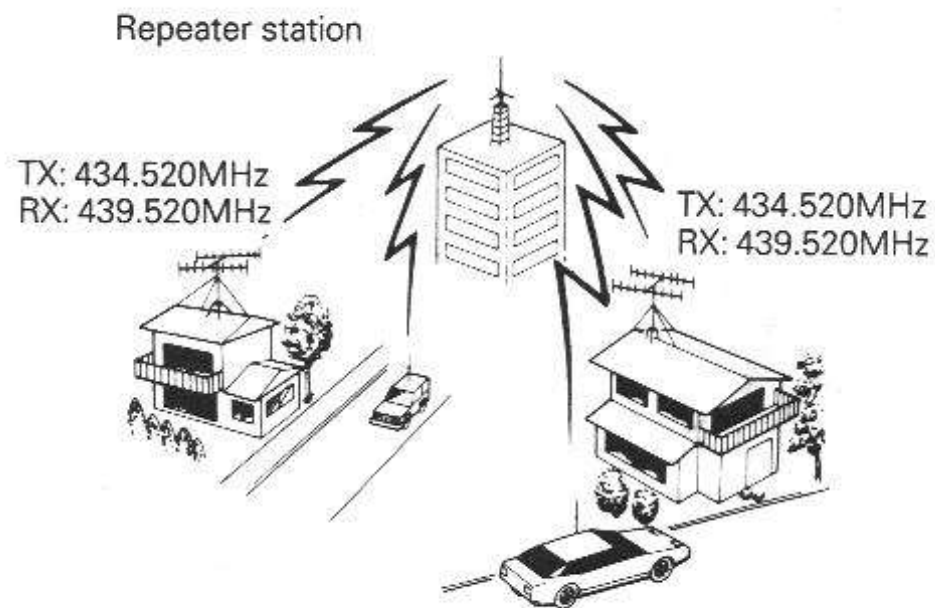

REPEATER OPERATION METHOD

1 Example of repeater operation

Procedure

- 1 Press the UHF button to use the UHF band.
- 2 Set the transceiver to the TX frequency of the repeater station to be used (439.52 MHz, for example) as follows. Press numeric buttons "9", "5" and "2" in this order. When numeric button "2" has been pressed, a long beep is generated to indicate that the operating frequency has been set (to 439.52 MHz).
- 3 While holding the FUNC button depressed, press the 8/RPT button to initiate the Repeater mode. "T" will appear on the display to indicate the Tone encode mode, and "-" will appear to indicate the Repeater mode.

Now the unit is ready for repeater operation.

- 4 Press the PTT button. The signal is transmitted at 434.52 MHz, which is the frequency offset by -5 MHz from the frequency set above, and accesses the desired repeater station.

Advice

- *When the transceiver accesses a repeater station, it receives the call sign (Morse codes) of the repeater station.
- *If the call sign of the desired repeater station cannot be received when the PTT button is pressed, your signal may not reach the repeater station, or your operation may be erroneous. Please try again from the beginning.

NOTE:

- * Many people may be using the same repeater station *simulta neously*. Therefore, please observe the rule of the station to avoid troubles with them.

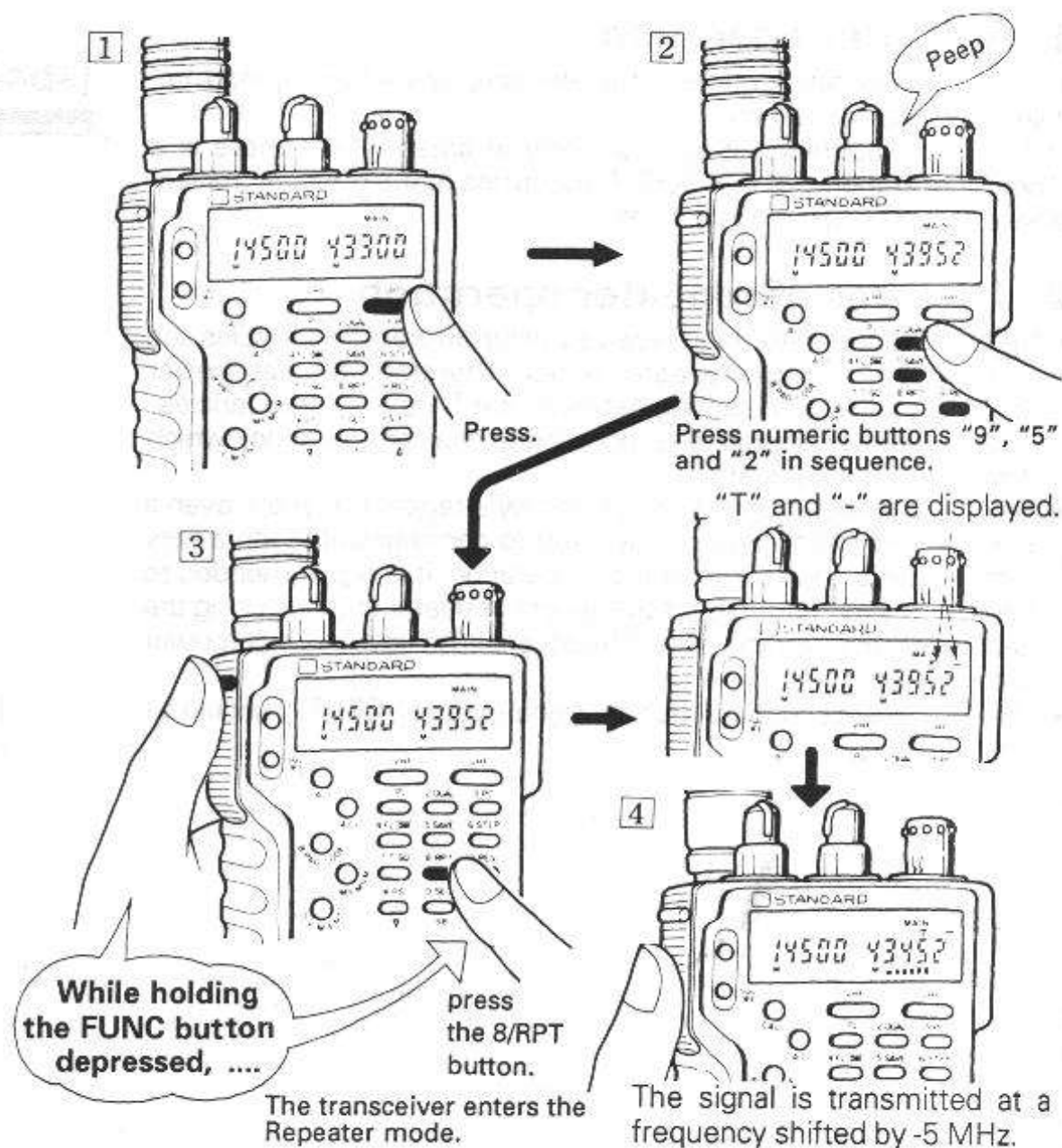

2 Application examples of Repeater operation

1. How to receive direct signal from the remote station (without by intermediate of a repeater station):

- While holding the FUNC button depressed, press the 9/REV button. "434.52" appears as the frequency display, and the signal transmitted from the remote station can be received directly. If the PTT button is pressed at this time, the signal is transmitted at 439.52 MHz, and the "-" or "+" offset frequency indicator flashes indicating the Reverse mode.
- If the direct signal from the remote station can be received, it indicates that there is no need of using the repeater station. It is recommended not to use the Repeater mode (this mode is called the Simplex mode) whenever the direct signal from the remote station can be received.

NOTE:

The wrong beep tone "boo" is generated when the shifted frequency goes off-band. In this case the desired frequency cannot be set.

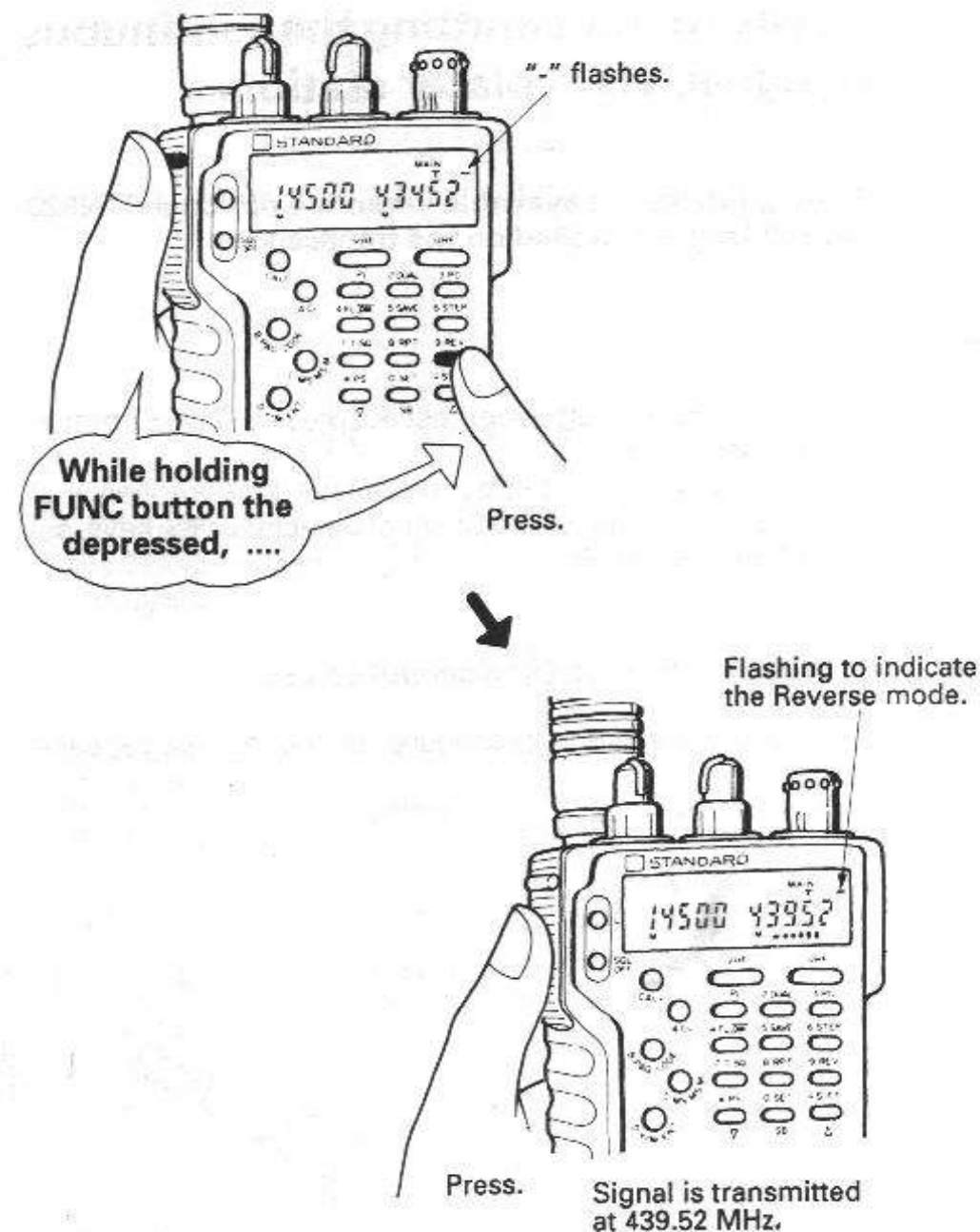

2. In the case of transmitting the continuous tone signal, via repeater station.

- The following function is available when the optional CTN520 Tone Squelch Unit is installed on the transceiver.

Procedure

- 1 While holding the FUNC button depressed, press the 0/SET button to initiate the Set mode.
- 2 Press the 7/T.SQ button to display the default tone frequency of 88.5 kHz. Then, using the Rotary Channel Selector or ∇/\blacktriangle keys, set the desired tone frequency.

NOTE:

Numeric buttons are defeated and cannot be used.

- 3 Hereafter, follow the same procedure as the normal repeater operation.

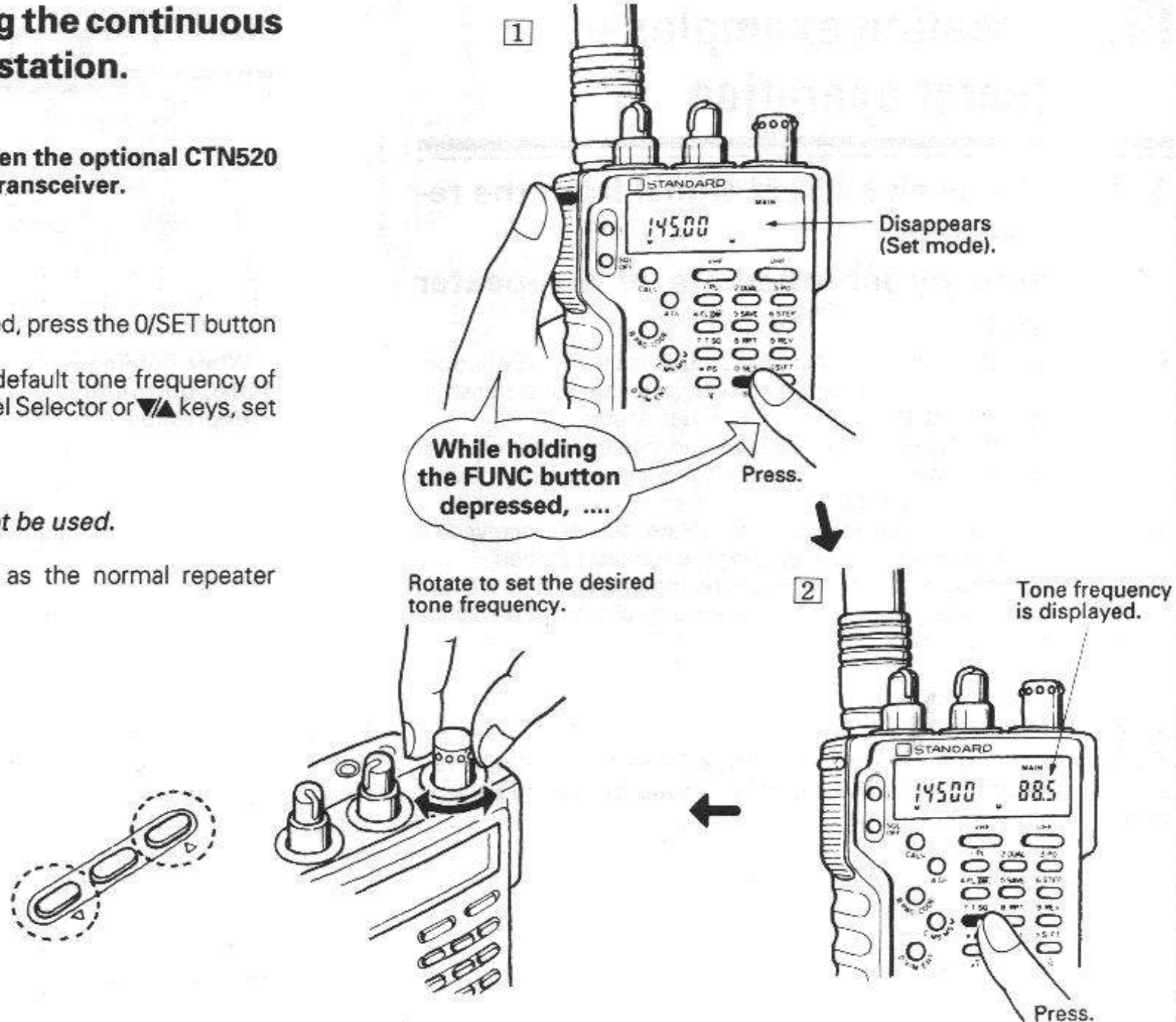

3. Operation by changing the offset frequency

(the offset frequency used with most repeater stations is -5 MHz)

Procedure

- 1 While holding the FUNC button depressed, press the 0/SET button to initiate the Set mode.
- 2 Press the 8/RPT button to display the default offset frequency of 5.00 (MHz). Then, using the Rotary Channel Selector, numeric buttons or ∇/\blacktriangle keys, set the desired offset frequency.
- 3 Hereafter, follow the same procedure as the normal repeater operation.

NOTE:

The TX frequency is smaller or larger than the RX frequency by the same amount as the shift width. If the TX frequency should shift beyond the range of the amateur band, the frequency display of the C528 shows "OFF" (off-band) and the signal will not be transmitted. In this case, set the RX frequency so that the TX frequency does not exceed the amateur band limits.

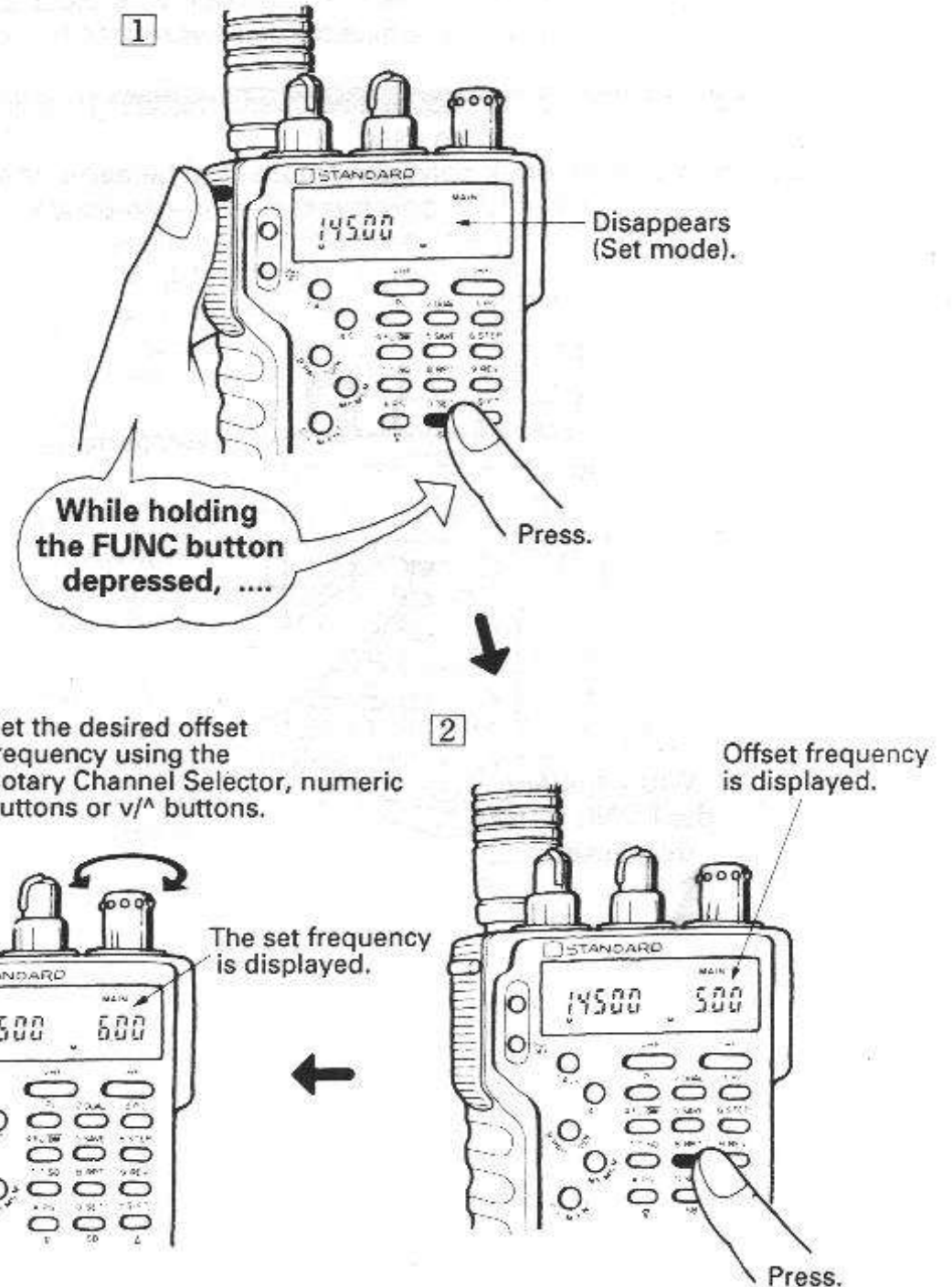

HIDING ONE OF THE BAND DISPLAYS

In case only the communication in the UHF band or VHF band is required, use the following procedure to hide the displays related to the unnecessary band.

- While holding the FUNC button depressed, press the VHF or UHF button according to the band to be used.

The display related to the other band disappears, and hereafter the unit can be used as a VHF or UHF-only transceiver (mono-bander).

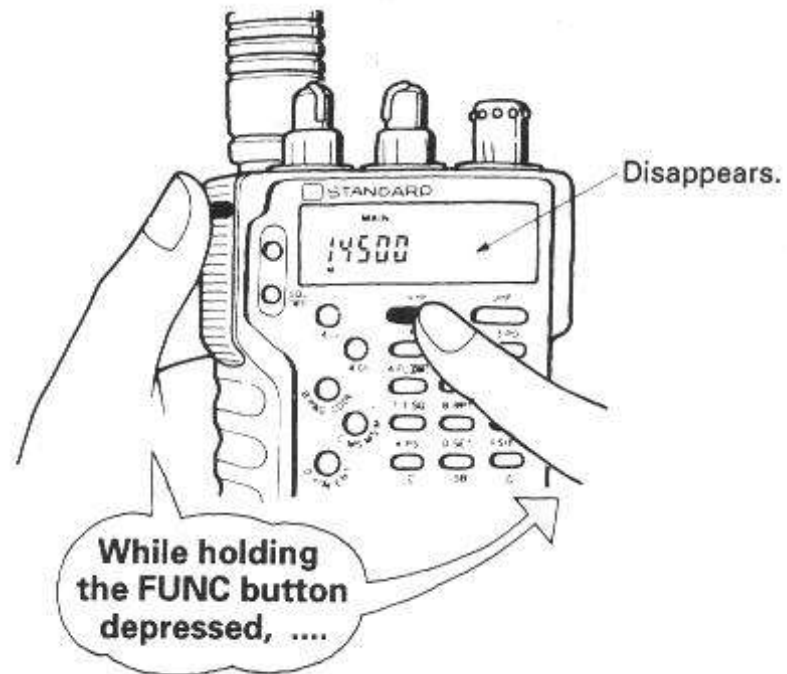

DUAL-WATCH FOR WATCHING A FREQUENTLY-USED FREQUENCY AND THE REPEATER STATION FREQUENCY ALTERNATELY

The Dual-Watch function allows to watch one of the memory frequencies (one of M1 to M9) and the VFO frequency alternately. The Dual-Watch is possible only within the same band. For example, to dual-watch 433.02 MHz and 439.52 MHz alternately, use the following procedure.

Procedure

- 1 Program one of the Dual-Watch object frequencies (433.02 MHz with this example) in memory address No. 1.
 - 1-1 [433.02] (MHz) is displayed.
 - 1-2 Press the DV/M ENT button to initiate the Memory Recall mode.
 - 1-3 Rotating the Rotary Channel Selector varies the memory address No. Rotate it so that M1 is displayed.
 - 1-4 While holding the FUNC button depressed, press the DV/M ENT button. A long beep tone is generated informing that 433.02 MHz has been programmed in M1.
 - 1-5 Press the DV/M ENT button again to cancel the Memory recall mode (the unit enters the Dial frequency mode).
- 2 Press numeric buttons "9", "5" then "2" to set the repeater station frequency (439.52 MHz), and initiate the Repeater mode (by pressing the 8/RPT button with the FUNC button held depressed).
- 3 While holding the FUNC button depressed, press the 2/DUAL button. The two frequencies (433.02 and 439.520) can be watched alternately.

- 4 Proceed to the following when it is required to start communication.
 - 4-1 When you are called with the memory frequency, first press the DV/M ENT button twice to cancel the Dual-Watch operation, then start communication.
 - 4-2 To communicate with the dial frequency, press the A/CL button to cancel the Dual-Watch operation, and start communication.

Advice

- *When a signal is received with the memory frequency, the Dual-Watch operation is suspended temporarily, and re-starts when the signal stops to be received.
- *When a signal is received with the VFO frequency, the Dual-Watch operation continues as before so the received sound may be intermittent; this is not a malfunction.
- *The Dual-Watch receives the memory frequency every 3 seconds and shows the received frequency on the display.
- *The Dual-Watch does not occur if no frequency has been programmed as the memory frequency.

1-1

Set a frequency using the Rotary Channel Selector, numeric buttons or ∇/Δ buttons.

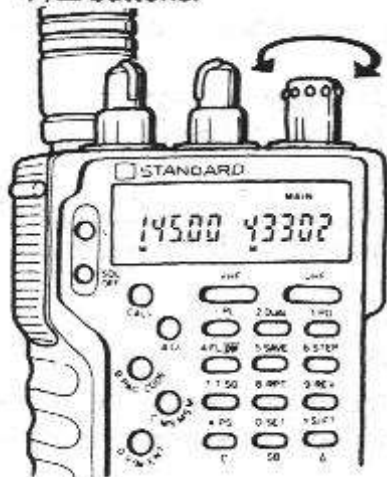

Set 433.02 MHz.

1-2

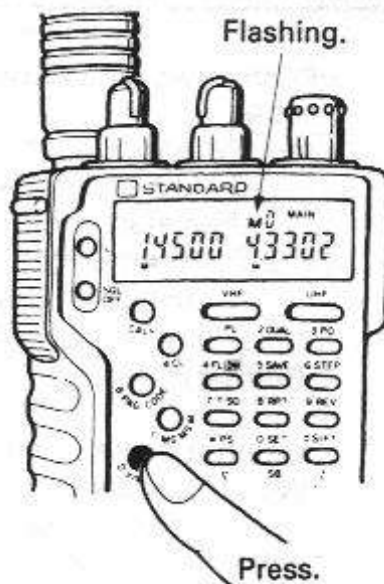

1-3

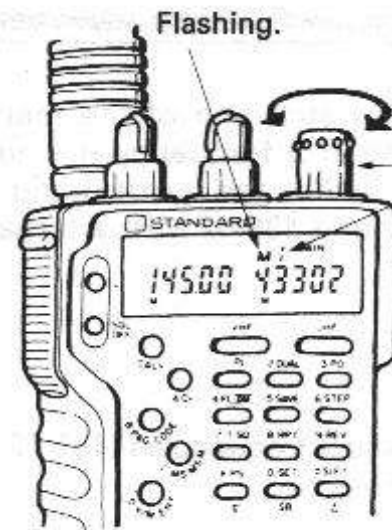

Set the memory address No. using the Rotary Channel Selector, numeric buttons or Δ/∇ buttons.

3

"DUAL" appears, and frequencies are watched alternately.

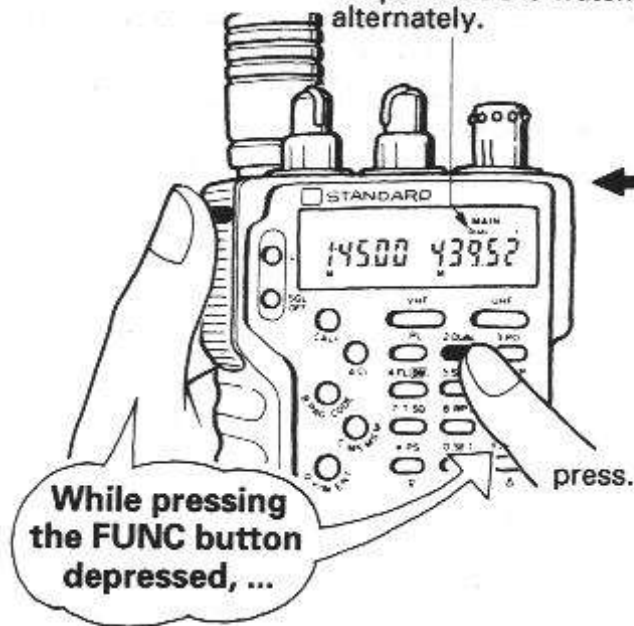

2

Set the same frequency as the repeater station frequency.

(While pressing the FUNC button depressed, press the 8/RPT button.)

1-5

"M" disappears, indicating the Dial frequency mode.

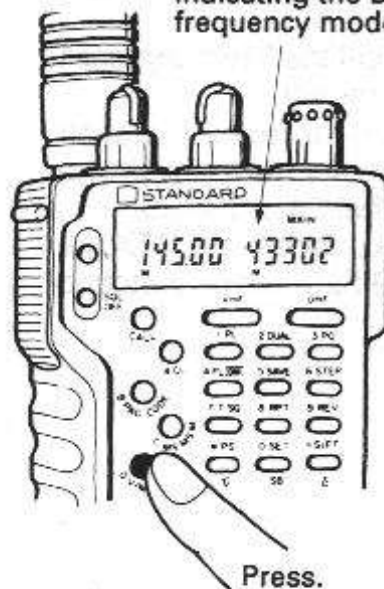

1-4

Displayed steadily, indicating that the frequency is programmed in M1.

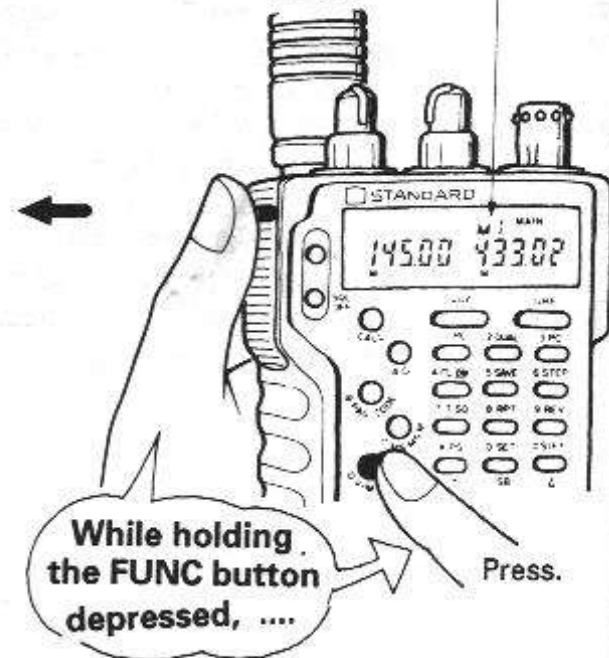

OTHER OPERATIONS

The frequencies shown in the illustrations are mere examples.

1 Memory Frequencies

1. The operating frequencies which are used most frequently can be programmed in the internal memory.
2. A total of 20 operating frequencies, 10 in the VHF band and 10 in the UHF band, can be programmed as the memory frequencies.
3. The memory frequencies can be recalled, changed or scanned freely.
4. The locations in which the memory frequencies are called "memory

2 Programming a Memory Frequency

Procedure

To allow a frequency to be programmed in memory, the desired frequency should first be displayed as the dial frequency.

Example: To program 145.20 MHz under M1 of VHF band. (The same procedure can also be used for the UHF band.)

- 1 Set the displayed dial frequency to 145.20 MHz.
- 2 While holding the FUNC button depressed, press the D V/M ENT button. The "M" will appear on the display.
- 3 Press numeric button "1".

A long beep tone will be generated to inform that the memory programming operation is complete.

The current conditions is referred to as the Memory recall mode.

- 4 Press the ACL button. The displayed frequency will not change but the unit returns to the Dial frequency mode.

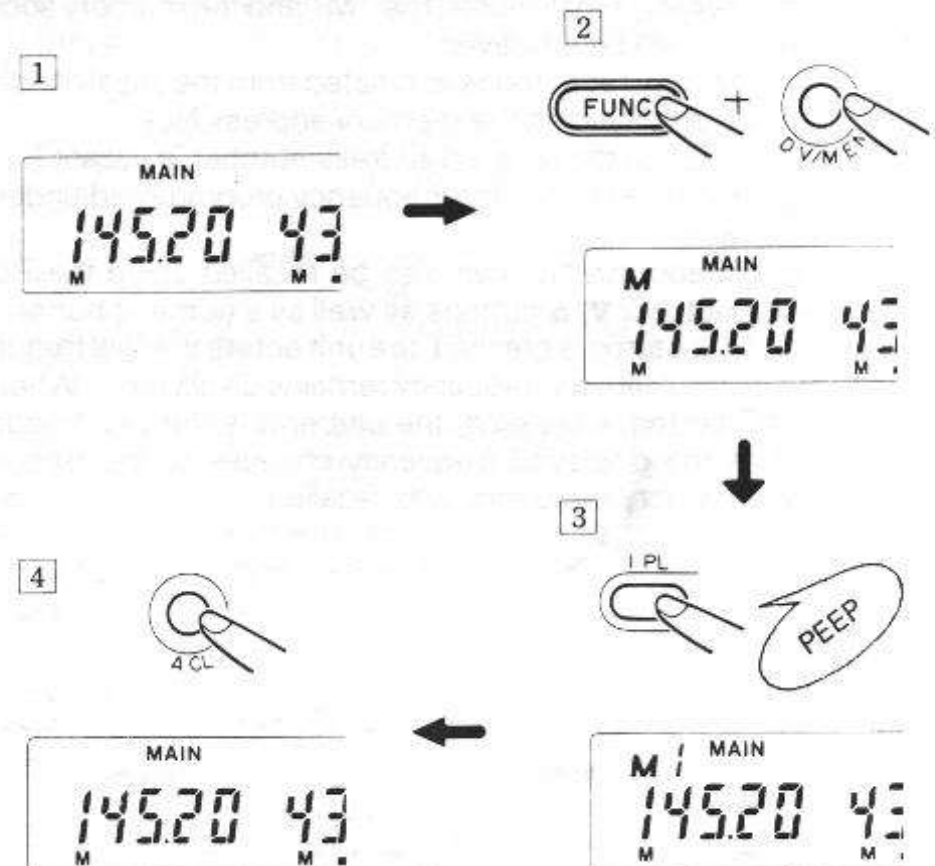

3 Recalling a Memory Frequency

Procedure

Example: To Recall M1.

- 1 From the Dial frequency mode, press the D V/M ENT button to initiate the Memory recall mode. The "M" and the memory address No. used lastly will be displayed.
When the Memory recall mode is initiated from the initial condition, "M0" will be displayed as the memory address No. ("M" flashes when the recalled address number is vacant.)
- 2 Press numeric button "1". The frequency programmed under M1 will be displayed.
The memory address No. can also be recalled using the Rotary Channel Selector or ∇/\blacktriangle buttons as well as a numeric button.
- 3 When the A CL button is pressed, the unit enters the Dial frequency mode while the memory frequency remains displayed. When the D V/M ENT button is pressed, the unit enters the Dial frequency mode while the displayed frequency changes to the frequency before the memory frequency was recalled.

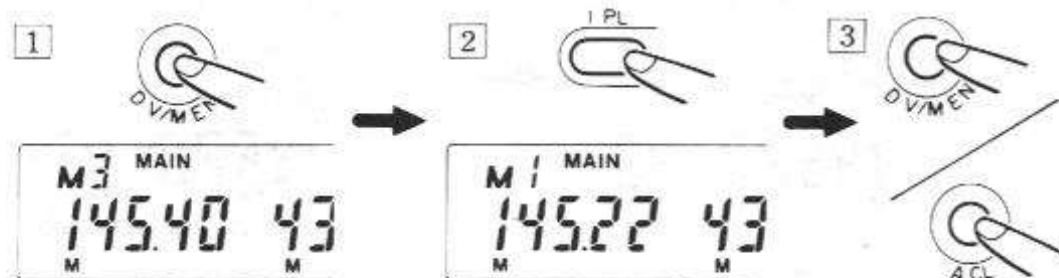

4 Changing a Memory Frequency

Procedure

Example: To change the memory frequency of 145.20 MHz under M1 of VHF band to 145.22 MHz.

- 1 Set the displayed dial frequency to 145.22 MHz.
- 2 While holding the FUNC button depressed, press the D V/M ENT button.
- 3 Press numeric button "1".
A long beep tone will be generated, informing that the 145.20 MHz memory frequency is replaced by the 145.22 MHz frequency.
- 4 When the A CL button is pressed, the unit enters the Dial frequency mode while the memory frequency remains displayed.

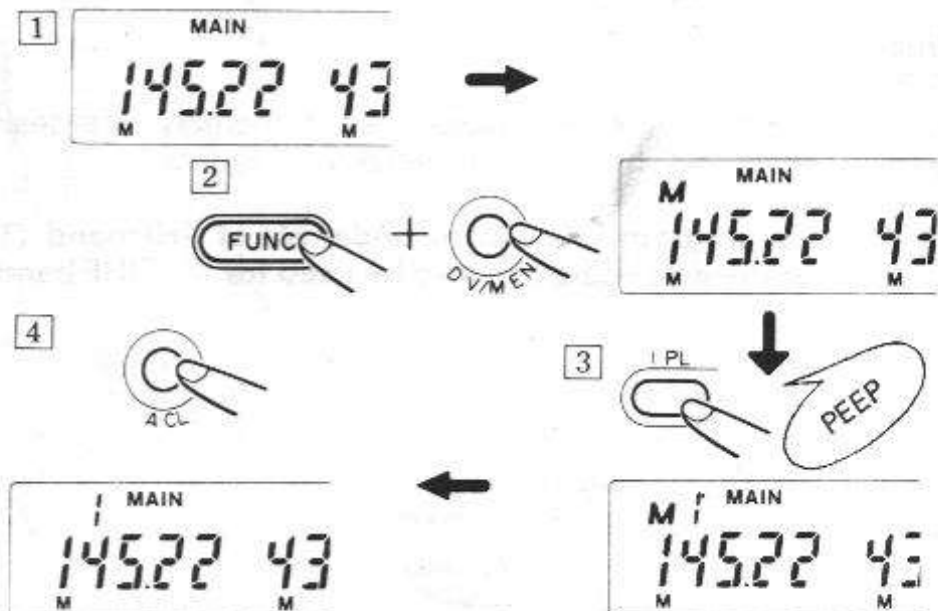

Advice

- *Any memory address No., M0 through M9, can also be replaced by rotating the Rotary Channel Selector in the Memory recall mode.
- *If no frequency has been programmed under the selected memory address No., the "M" on the display flashes to inform that the memory address No. is vacant. In this case, the dial frequency remains displayed on the frequency display.
- *Pressing the D V/M ENT button in the Dial frequency mode initiates the Memory recall mode, and pressing the same button in the Memory recall mode initiates the Dial frequency mode.

5 Deleting a Memory Frequency

Follow the procedure below to delete the programmed frequency in memory.

Procedure

Example: To delete the frequency programmed under M1.

- 1 Press the D V/M ENT button to initiate the Memory recall mode.
 - 1-1 If the "TSQ", "+" and/or "-" are being displayed, turn off these indicators.
For the method of turning off these indicators, please refer to the description of each of them.

- 1-2 If the tone frequency and/or offset frequency have been changed, return them to the initial values. Initial value of tone frequency: 88.5 Hz (UHF/VHF)
Initial value of offset frequency: 5.00 MHz (UHF),
0.06 MHz (VHF)
- 2 While holding numeric button "1" depressed, press the A CL button.
A long beep tone will be generated and the "M" on the display will start flashing, informing that the frequency programmed under M1 has been deleted.
- 3 The frequency being displayed becomes the dial frequency (but the unit remains in the Memory recall mode).
- 4 After the memory frequency has been deleted, set the unit in the Dial frequency mode by pressing the D V/M ENT or A CL button.

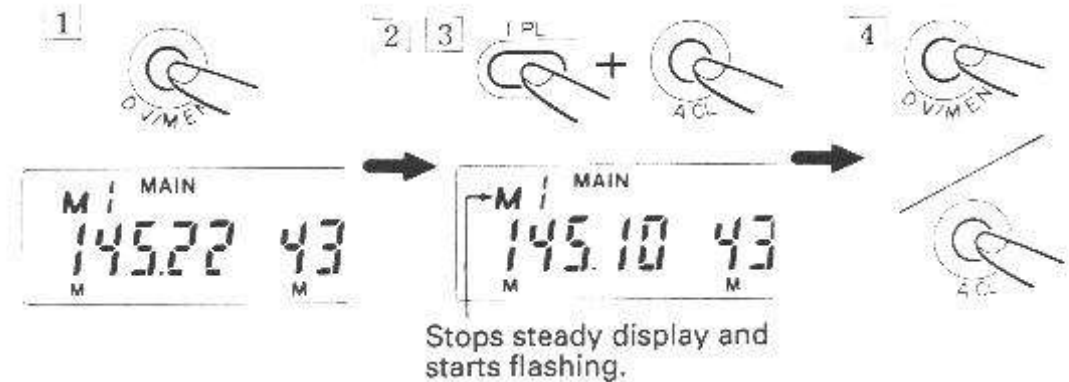

NOTE:

When deleting a memory frequency with which the Repeater mode has been written, cancel its Repeater mode before deleting the memory frequency.

If the Repeater mode is not canceled, the Repeater mode will remain written in the memory address No. which becomes vacant.

6 Scanning [C MS MS.M Button]

• **Scanning Method**

Either Pause Scan or Busy Scan can be selected.

• **Pause Scan**

Pause Scan ceases scanning when a signal is received. Scanning will then resume five seconds later or when the signal disappears, whichever occurs first.

• **Busy Scan**

Busy Scan stops scanning when a signal is received, but scanning resumes two seconds after the signal disappears.
(The transceiver is initially set to Pause Scan.)

Advice

The scanning method can be switched also during scanning.

• **Scanning operations of the C528**

This unit is capable of the following scan operations.

1. Dial-frequency scan operations

- 1) 1 MHz Scan: Scans within any desired 1 MHz segment.
- 2) Programmed Scan: Scans within the specified frequency range.

2. Memory-frequency scan operations

- 1) Memory Scan (MS)
- 2) Memory Scan Memory (MS.M)

NOTE:

Save Memory Scan occurs during Battery-Save operation.

3. Tone-frequency Scan operation

- 1) Scans the tone frequencies.

6.1 Dial-frequency Scan operations

① 1 MHz Scan

- In the Dial frequency mode, press the * PS button with the FUNC button held depressed. The 1 MHz Scan will start.
- The point to the below right of the MHz figure on the display flashes during scan operation.
- Press the A CL button to cancel the scanning.

Advice

- *The display has no indicators for distinction between the 1 MHz Scan and All Scan operations.
- *When the ▼ or ▲ button is pressed during scanning, it stops temporarily (Pause mode). Press the same button again to resume scanning. It is also possible to reverse the scanning direction (upward or downward).
- *Press the ▼ or ▲ button and hold it for more than 0.5 second to scan the frequencies continuously at a higher speed.

6.2 Programmed Scan operation

This function allows you to scan the range between two memory frequencies.

The start frequency where scanning starts and the end frequency where it ends should previously be programmed in memory.

NOTE:

The Programmed Scan cannot be used if the frequencies have not been programmed.

Before starting the Program Scan, set the memory address Nos. following the procedure below.

Procedure

- 1 Press the D V/M ENT button to initiate the Memory recall mode.
- 2 Specify the start frequency (its memory address No.).
(Any of the Rotary Channel Selector, v/^ buttons and numeric buttons can be used.)
- 3 While holding the FUNC button depressed, press the * PS button. The displayed memory address No. will start flashing.
- 4 Specify the end frequency (its memory address No.).
(Only the numeric buttons can be used.)
- 5 The Programmed Scan starts at the same time as the memory address No. for the end frequency (the numeric button) is pressed.

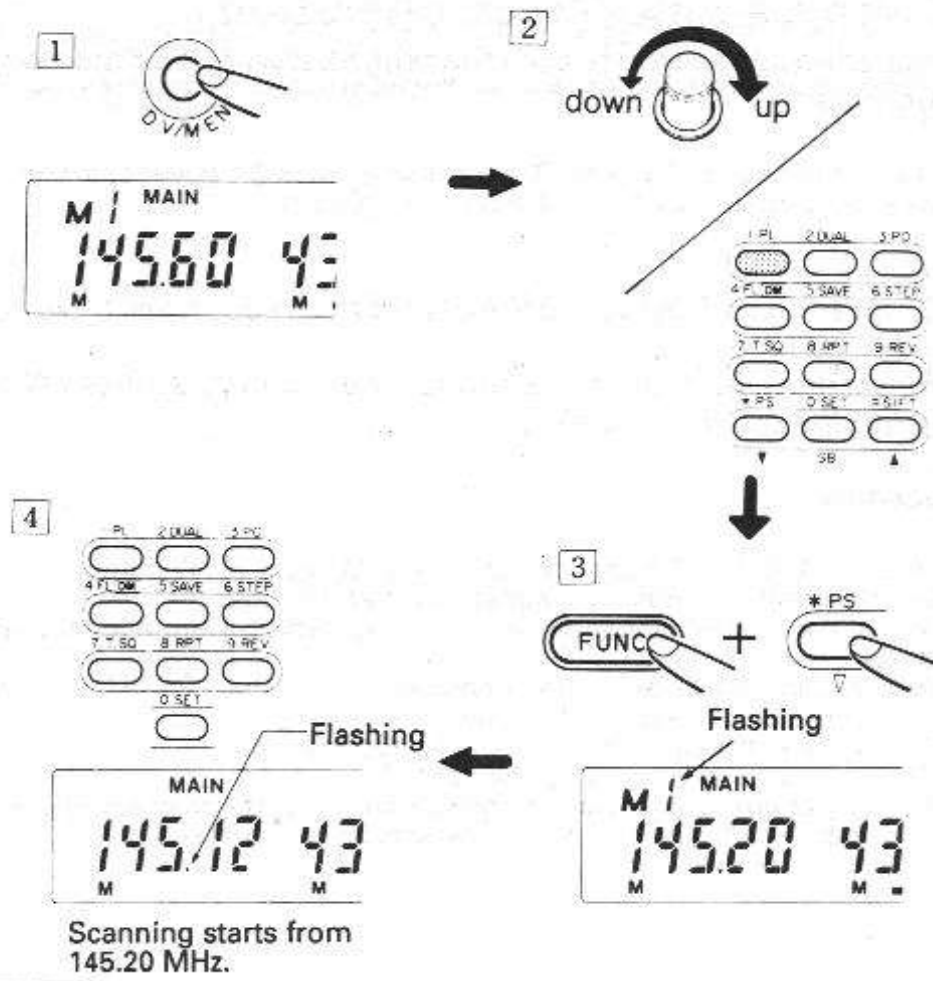

Scanning starts from 145.20 MHz.

Advice

If the start frequency is higher than the end frequency, the Program Scan occurs in the downward direction (counting down the frequencies).

Example: When the start frequency is 145.80 (MHz) and the end frequency is 144.10 (MHz).

In this example, the frequencies are scanned downwards, from 145.80, 145.78, 145.76,

6.3 Memory-frequency Scan

(1) Memory Scan

The Memory Scan scans only those frequencies that have been programmed in memory.

- 1 Press the MS/MS.M button to start Memory Scan.
- 2 Press the MS/MS.M button again to cancel the Memory Scan. When the D V/M ENT button is pressed during Memory Scan, the transceiver enters the Dial frequency mode with the last frequency set before the Memory Scan was initiated.
- 3 The Memory Scan in the Battery-save mode scans one memory frequency per second and receives it only intermittently (200 ms each).

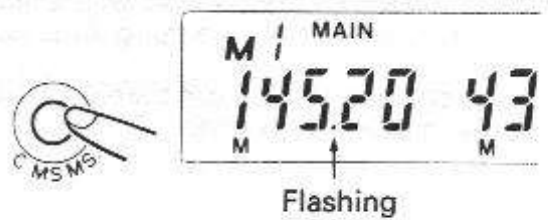

(2) MS.M Scan

This function allows you to scan certain memory frequencies in priority. The MS.M (Memory Scan Memory) scans only the specified memory frequencies.

Set the address Nos. to be scanned in priority by the MS.M and initiate the MS.M Scan following the procedure below.

Procedure

- 1 Press the D V/M ENT button to initiate the Memory frequency recall mode.
- 2 Display a memory address No. to be scanned.
 - 2-1 While holding the FUNC button depressed, press the MS/MS.M button. "▼" will appear above "M" to indicate that the memory address No. will be scanned in priority by the Memory Scan Memory.
- 3 After starting the Memory Scan, press the C MS/MS.M button with the FUNC button held depressed. The Memory Scan Memory operation will start. (To resume the ordinary Memory Scan, repeat the same operation again.)

Advice

When, in the Dial frequency mode, the C MS/MS.M button is pressed with the FUNC button held depressed, "▼" appears above "M" on the display. Now, the Memory Scan Memory operation can be started by pressing the C MS/MS.M button.

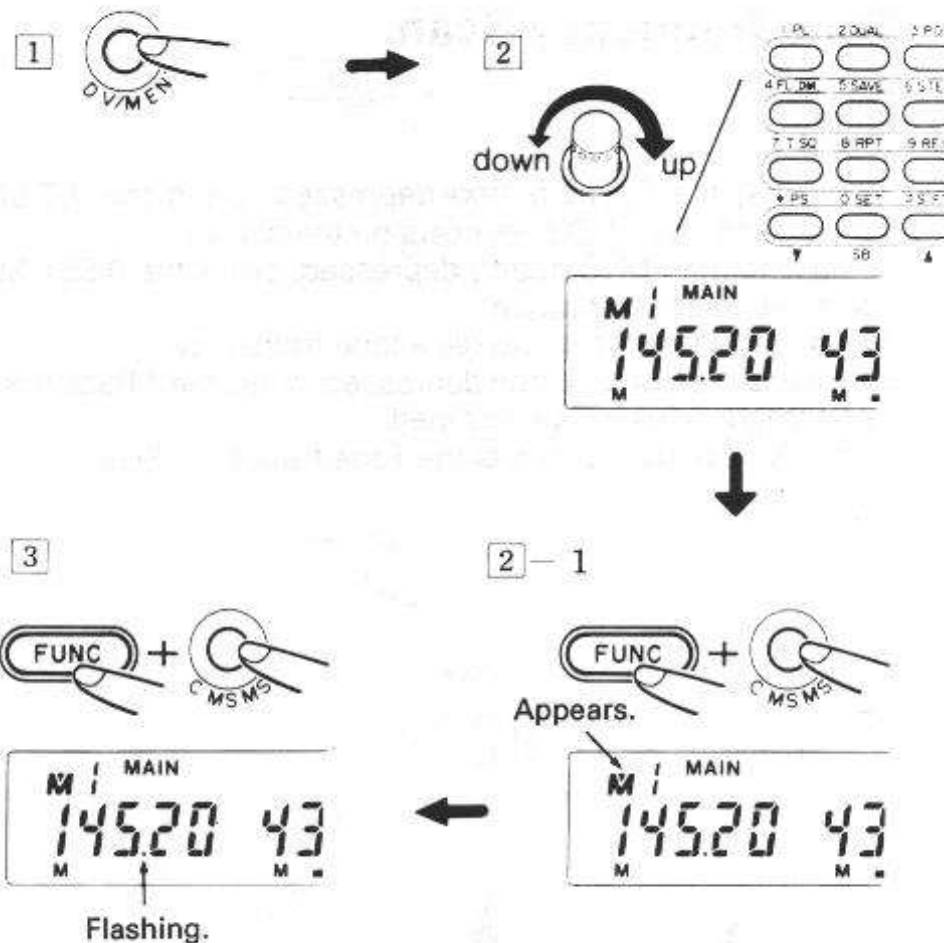

6.4 Tone-frequency Scan

Procedure

- 1 While holding the FUNC button depressed, press the 7/T.SQ button twice so that "T.SQ" appears on the display.
- 2 While holding the FUNC button depressed, press the 0/SET SB button to initiate the Set mode.
- 3 Press the 7/T.SQ button to display a tone frequency.
- 4 While holding the FUNC button depressed, press the *PS button. The tone frequencies will be scanned.
- 5 Press the A/CL button to cancel the Tone-frequency Scan.

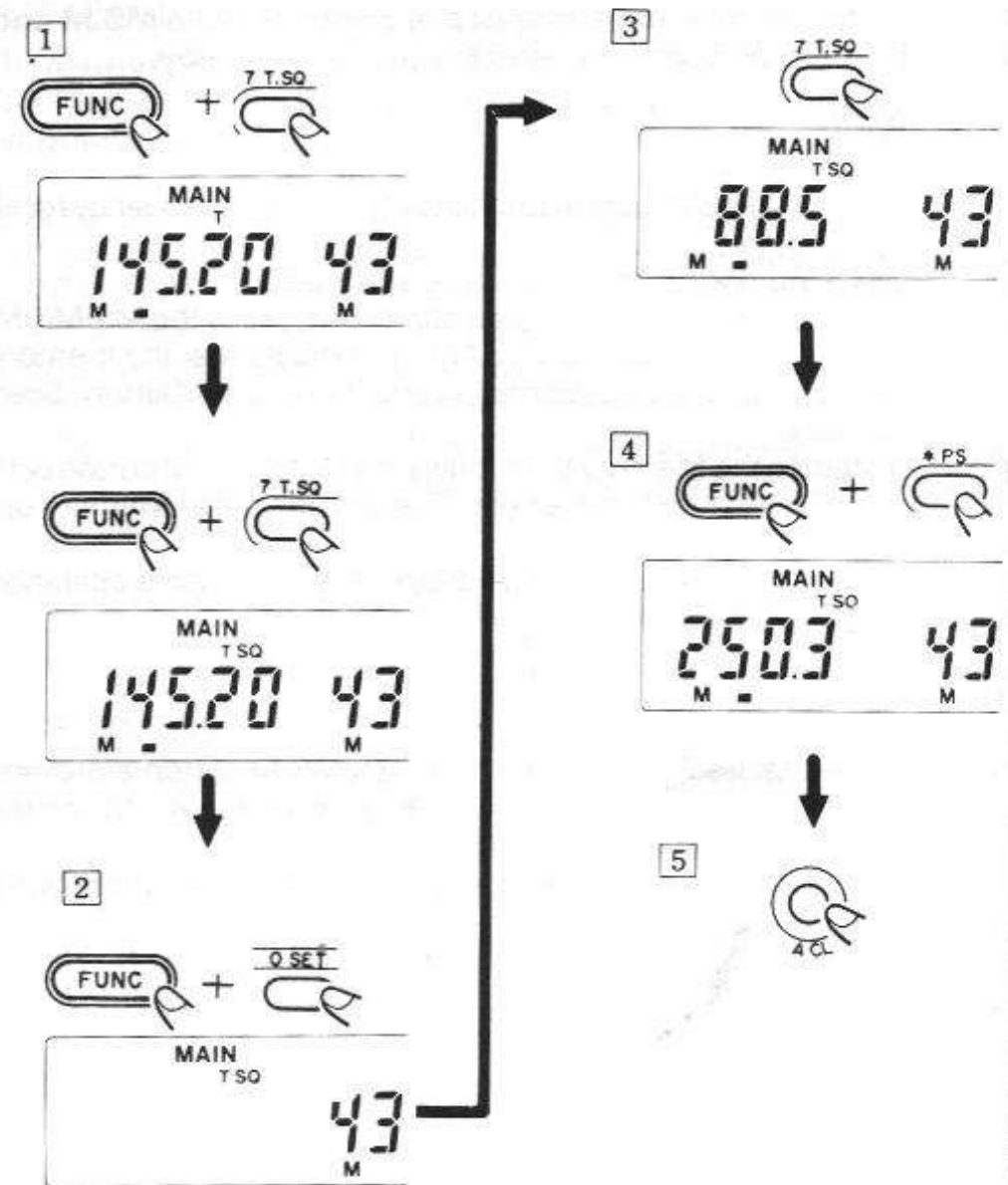

7 Switching the Transmit Power [3/PO Button]

This is to switch the transmit power (which has been set to Middle power when the unit left the factory).

Three power levels are available for the C528.

Select High, Middle or Low power depending on your purpose.

- When the display shows "H" (High power) — 5.0 W
(with 13.8 V supply)
- When the display shows "M" (Middle power) — 2.5 W
(with 13.8 V supply)
- When the display shows "L" (Low power) — 0.35 W

Procedure

- 1 While holding the FUNC button depressed, press the 3/PO button. The "M" on the bottom left of the display will be replaced by "L" indicating that the transmit power is switched from Middle to Low.
- 2 While holding the FUNC button depressed, press the 3/PO button again. The "L" will be replaced by "H" indicating that the transmit power is switched from Low to High.
- 3 While holding the FUNC button depressed, press the 3/PO button again. The "H" will be replaced by "M" indicating that the transmit power is switched from High to Middle. When the Middle power is returned the "puff" beep tone is generated to inform it.

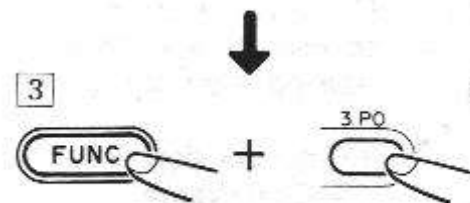
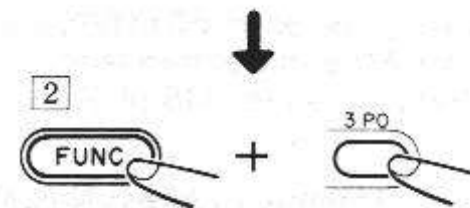
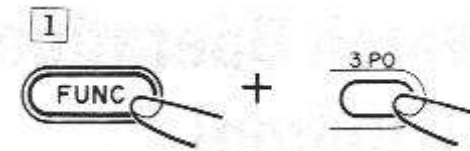

8 Dual-Watch Operation [2/DUAL Button]

The Dual-Watch functions allow you to set two frequencies in the Receive standby mode.

The C528 is capable of Dual-Watch operations between the following frequencies.

- (1) One of memory frequencies in M0 to M9, and dial frequency.
- (2) Memory frequency M1 and dial frequency.
- (3) Memory Scan frequencies (or MS.M Scan frequencies) and dial frequency.

- (1) **Dual-Watch on one of memory address Nos. M1 to M9 and dial frequency**

Procedure

- 1 Set the transceiver to the Memory recall mode and recall a memory address No.
- 2 While holding the FUNC button depressed, press the 2/DUAL button. The Dual-Watch will occur between the frequency programmed under the recalled memory address No and dial frequency.
- 3 While holding the FUNC button depressed, press the 2/DUAL button again to cancel the Dual-Watch.

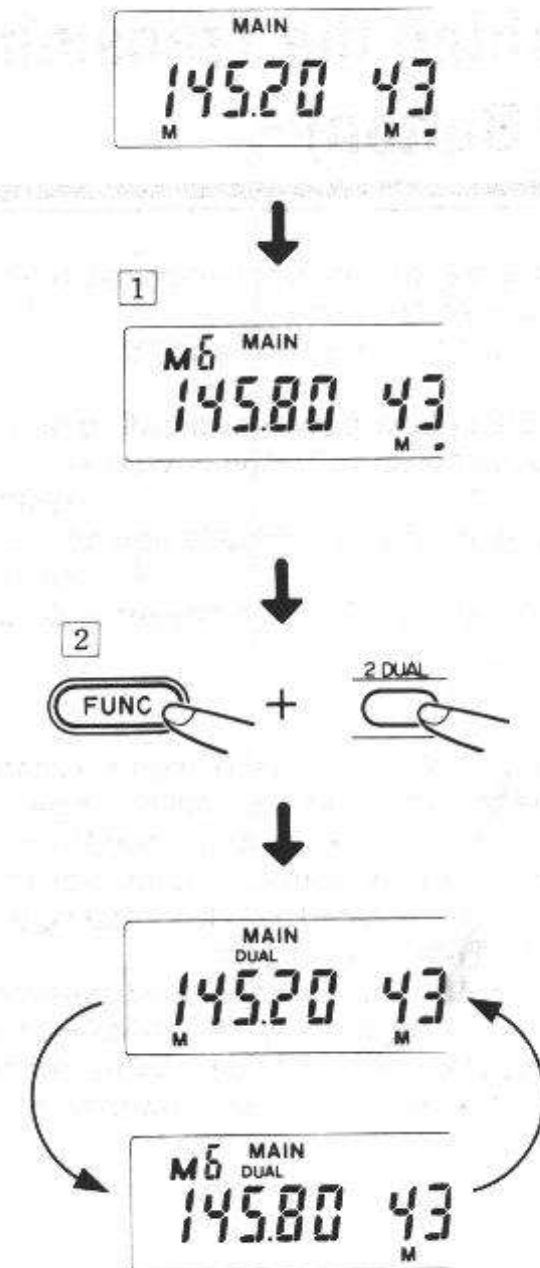

(2) Dual-Watch on memory frequency M1 and the dial frequency

Procedure

- 1 Program the frequency to be Dual-Watched in memory address No. 1.
- 2 While holding the FUNC button depressed, press the 2/DUAL button. The Dual-Watch will occur between the frequency programmed under memory address No. M1 and dial frequency.
- 3 While holding the FUNC button depressed, press the 2/DUAL button again to cancel the Dual-Watch.

(3) Dual-Watch on Memory Scan frequencies (or MS.M Scan frequencies) and dial frequency

Procedure

- 1 Initiate the Memory Scan mode (or MS.M Scan mode).
- 2 While holding the FUNC button depressed, press the 2/DUAL button. The Dual-Watch will occur between each of the frequencies scanned by Memory Scan (or MS.M Scan) and the dial frequency.
- 3 While holding the FUNC button depressed, press the 2/DUAL button again to cancel the Dual-Watch.

9 Changing the Tuning Step [6/STEP Button]

This function allows you to change the tuning step of this unit. The channel step rate of this unit can be switched in 6 steps; 5 kHz, 10 kHz, 12.5 kHz, 20 kHz, 25 kHz and 50 kHz. Select the one that suits the required operation.

Procedure

- 1 While holding the FUNC button depressed, press the 6/STEP button. The frequency display will disappear and replaced by the current tuning step rate.
- 2 Rotate the Rotary Channel Selector. The six steps will be displayed sequentially, and the "puff" beep tone is generated every time the display returns to 5 kHz.
- 3 Stop rotating the Rotary Channel Selector when the desired tuning step rate is displayed. Then press the A/CL button to set that tuning step.

Advice

- * When the tuning step is 12.5 kHz, small "50" is displayed to the right of displayed figure "12".
- * The tuning step has initially been set to 5 kHz at the factory.

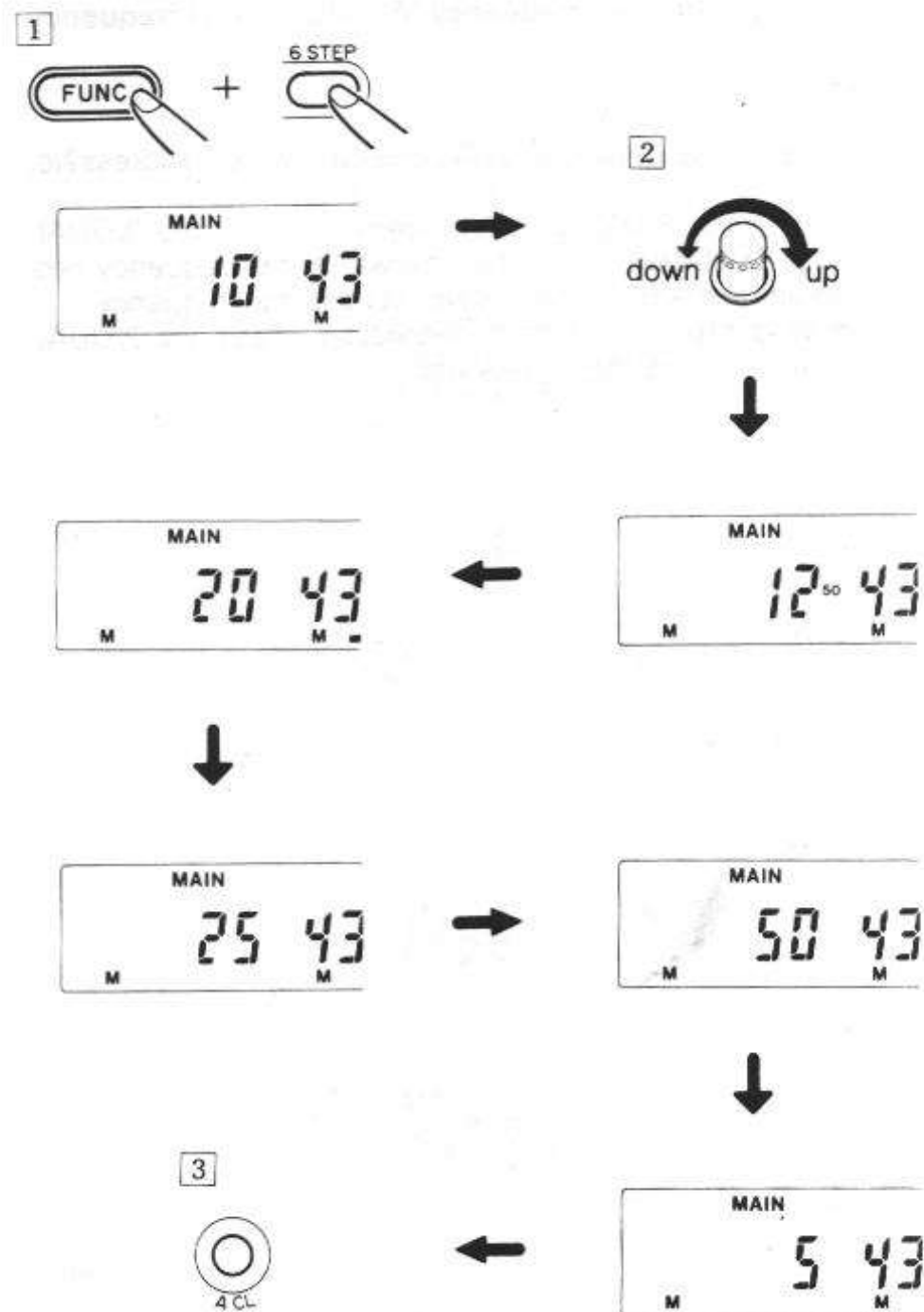

10 Battery-Save Function [5/SAVE Button]

This function reduces the current drain during receiver standby and thereby helps reduce the battery power consumption in case a long period of receiver standby is expected.

In the Battery-Save mode, the receiver is activated once every single second, so the battery consumption can be reduced to about 1/3 compared to when the Battery-Save function is not used.

Procedure

- 1 While holding the FUNC button depressed, press the 5/SAVE button. An "S" will appear on the top right of the frequency display to indicate that the Battery-Save function is enabled.
- 2 While holding the FUNC button depressed, press the 5/SAVE button again to cancel the Battery-Save function.

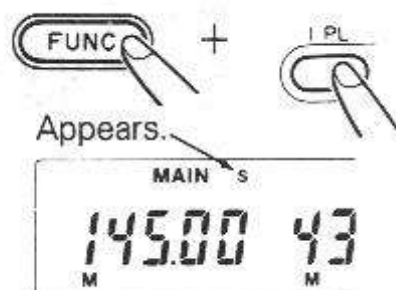

NOTES:

- * The Battery-Save function is disabled during Dual-Watch or Dial-frequency Scan operation.
- * When using the Pager function, cancel the Battery-Save function before it.

11 Frequency Lock Function [4/FL Button]

This function allows you to lock the current frequency and operating mode to prevent improper operation due to accidental mistakes during communication.

The Frequency Lock can also be engaged during scanning operations and Dual-Watch operation to prevent malfunction due to operation mistakes.

Procedure

- 1 While holding the FUNC button depressed, press the 4/FL button. An "FL" will appear on the left of the display to indicate that the Frequency Lock function is enabled.
- 2 While holding the FUNC button depressed, press the 4/FL button again to cancel the Frequency Lock function.

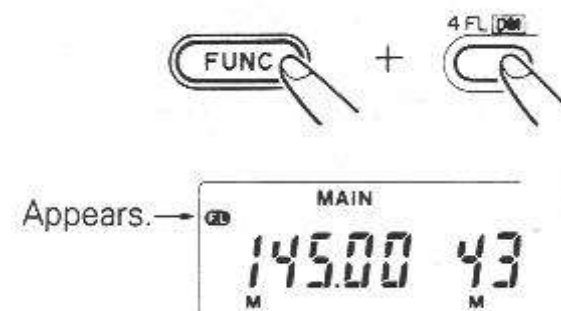

12 PTT Lock Function for Disabling PTT Button Operation [1/PL Button]

This function allows you to disable the PTT button to reduce the chance of accidental transmission when the unit is attached to the belt, etc. When this function is activated, the signal is not transmitted even when the PTT button is pressed.

Procedure

- 1 While holding the FUNC button depressed, press the 1/PL button. A 'PL' will appear on the left of the display to indicate that the PTT Lock function is enabled.
- 2 While holding the FUNC button depressed, press the 1/PL button again to cancel the PTT Lock function.

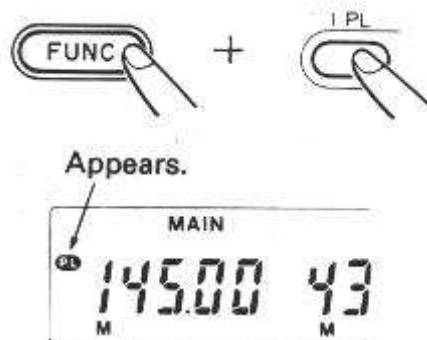

13 Switching Pause Scan/Busy Scan [0/SET SB Button]

This function allows you to select either Pause Scan or Busy Scan mode. The unit has initially been set to Pause Scan at the factory.

Procedure

- 1 Start scanning operation.
- 2 When the 0/SET SB button is pressed, the "B" will appear on the display to indicate that the scanning is performed as Busy Scan.
- 3 When the 0/SET SB button is pressed again, the "B" will disappear from the display, indicating that the scanning is performed as Pause Scan.



14 Tone Squelch Function [7/T.SQ Button]

The Tone Squelch operation is available when the optional Tone Squelch Unit (CTN520) is used.

Procedure

- 1 While holding the FUNC button depressed, press the 7/T.SQ button once. A "T" will appear to indicate the Tone encode mode. The press the 7/T.SQ button again with the FUNC button held depressed. A "SQ" will appear additionally and the unit enters the Tone Squelch operation mode. (The "T.SQ" also appears even when the CTN520 Tone Squelch Unit is not installed.)
- 2 While holding the FUNC button depressed, press the 7/T.SQ button again to cancel the Tone Squelch mode.

NOTES:

- * In the Tone Squelch mode, communications between stations using the same tone frequency are available, but communications with stations using different tone frequencies or with stations incapable of Tone Squelch operation are unavailable.
- * Select and program the required tone frequency before attempting Tone Squelch operation.

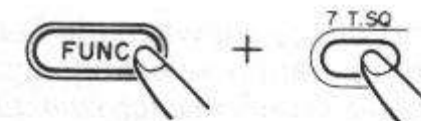
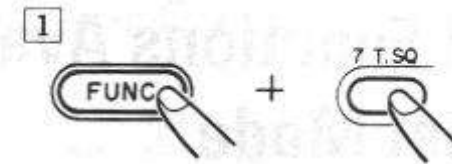

15 Special Functions Available in the Set Mode [0/SET SB Button]

While holding the FUNC button depressed, press the 0/SET SB button to enter the Set mode.

In the Set mode, the following special functions are available.

NOTES:

- 1. The display contents disappear when the Set mode is initiated. As the subsequent operation selections cannot be identified from the display, please confirm each selection made by actual operation.*
- 2. Be sure to cancel the Set mode after performing operations in the Set mode.
For the Set mode cancel method, refer to each of the following procedures.*
- 3. For the button operations in the Set mode, refer to the Button Function Lists.*

15.1 Recalling/Changing the Tone Frequency

This function is available when the optional CTN Tone Squelch Unit is installed.

This function allows you to select any one of the thirty-eight tone frequencies which have been stored in the microcomputer of the C528.

The selected tone frequency is recalled and shown on the display.

Procedure

- 1** While holding the FUNC button depressed, press the 0/SET SB button to enter the Set mode.
The frequency displays will disappear.
- 2** Press the 7/T.SQ button. The initial tone frequency value of 88.5 Hz will be displayed.
- 3** Rotate the Rotary Channel Selector. The available tone frequencies will be displayed sequentially, and the "puff" beep tone is generated every time the display returns to 88.5 Hz.
- 4** Stop rotating the Rotary Channel Selector when the desired tone frequency is displayed. Then press the A/CL button to return to the previous condition.

Available Tone Frequencies (in Hz)

67.0	71.9	74.4	77.0	79.7	82.5	85.4
88.5	91.5	94.8	97.4	100.0	103.5	107.2
110.9	114.8	118.8	123.0	127.3	151.8	136.5
141.3	146.2	151.4	156.7	162.2	167.9	173.8
179.9	186.2	192.8	203.5	210.7	218.1	225.7
233.6	241.8	250.3				

1

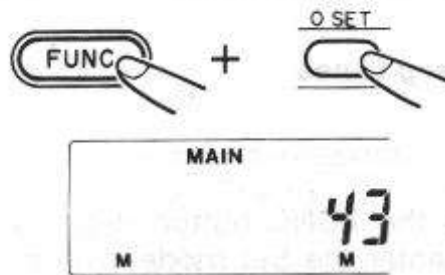

2

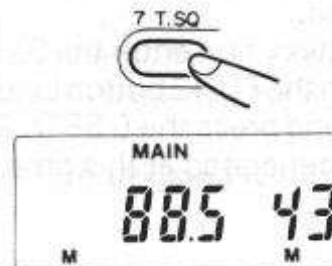

3

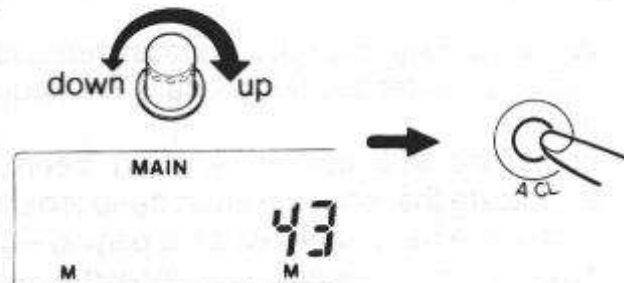

15.2 Auto Power Off

An Auto-Power Off function is built in to conserve power. When the transceiver is left unused with the Power switch turned on for 30 minutes, the transceiver will generate beep alarm. One minute after the alarm, the transceiver will automatically enter a near-off condition to minimize the battery power consumption.

In this condition, the current drain is reduced to less than 1 mA.

Procedure

- 1 While holding the FUNC button depressed, press the 0/SET SB button to enter the Set mode. The frequency displays will disappear.
- 2 Press the 5/SAVE button. An "AP" will appear to indicate that Auto-Power Off is activated.
- 3 When the numeric buttons, PTT button and SQL OFF button have not been operated or a signal has not been received for 30 minutes, an alarm tone of five short-beep tones are generated, and the "AP" on the display starts flashing.
- 4 One minute after the alarm, the transceiver will extinguish the most of the display and enters a near-off condition. (This condition is referred to as the Sleep standby mode.)
- 5 To cancel the Sleep standby mode and turn on the power, press the CALL button (or rotate the Power switch to OFF then to ON again). (However, this will not cancel Auto-Power Off.)
- 6 To cancel the Auto-Power Off, press the 0/SET SB button with the FUNC button held depressed, then press the 5/SAVE button with out releasing the FUNC button. The "AP" will disappear to indicate that Auto-Power Off is canceled.)

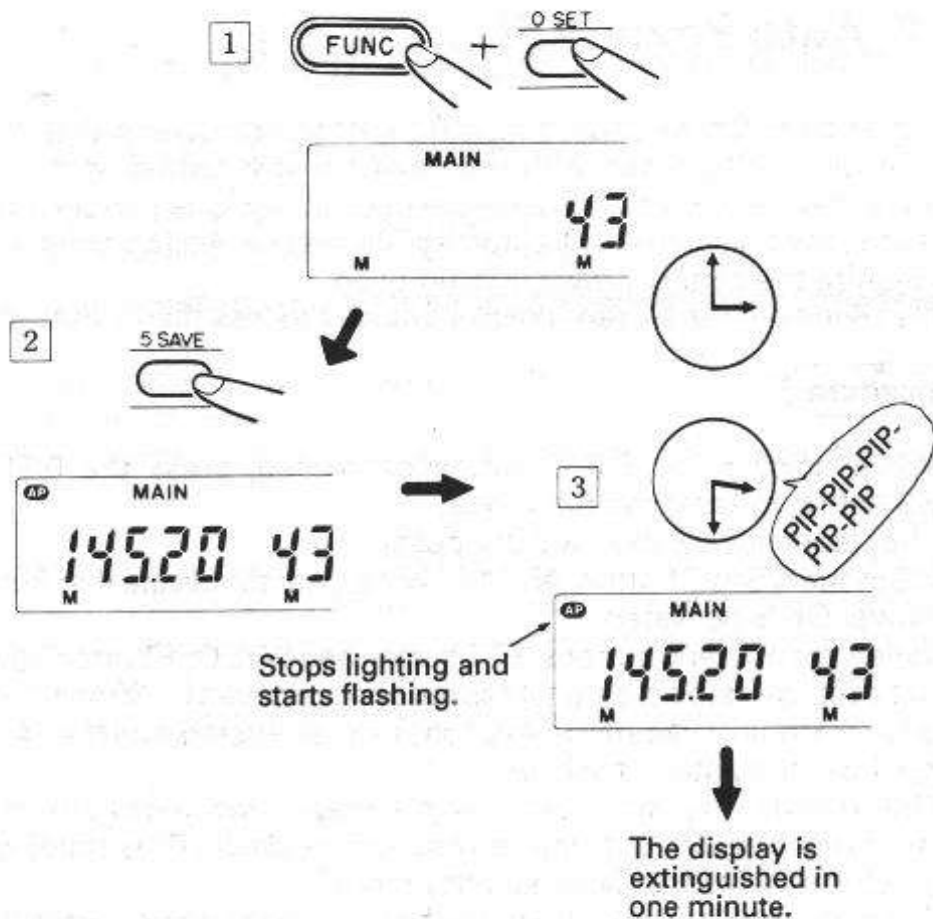

NOTES:

1. The transmit/receive circuits are not operating while the display is extinguished. Therefore, communication is not available in the Sleep standby mode.
2. Although the Auto-Power Off function enables to reduce the battery power consumption to a minimum, make sure that the power is turned off whenever you finish operation.

15.3 Other Functions

1. Muting the beep tones

Procedure

- 1 While holding the FUNC button depressed, press the 0/SET SB button to enter the Set mode. (The frequency displays will disappear.)
- 2 Press the 0/SET SB button again. You will notice that the short beep tone is not generated at this time. Hereafter, no beep tones will not be generated whatever operations are performed.
- 3 To cancel this function, first enter the Set mode by pressing the 0/SET SB button with the FUNC button held depressed, then release the FUNC button and press the 0 SET/SB button alone. A "puff" beep tone will be generated at this time, indicating that the beep tone is unmuted.

2. Changing the repetition count of beep tones during Pager operation

Procedure

- 1 While holding the FUNC button depressed, press the 0/SET SB button to enter the Set mode. (The frequency displays will disappear.)
- 2 Press the 1/PL button. A short beep tone will be generated to indicate that only one short beep tone will be generated, in place of the five beep tone, when a paging signal is received.
- 3 To cancel this function, first enter the Set mode by pressing the 0/SET SB button with the FUNC button held depressed, then release the FUNC button and press the 1/PL button alone. A "puff" beep tone will be generated at this time, indicating that the normal five beep tone will be generated when a paging signal is received.

3. Enabling the entry of the figure of 1 kHz

Procedure

- 1 While holding the FUNC button depressed, press the 0/SET SB button to enter the Set mode. (The frequency displays will disappear.)
- 2 Press the 2/DUAL button. A short beep tone will be generated and a "▶" will appear on the right of the display of the figure of 1 kHz. The entry of the figure of 1 kHz is possible while this "▶" indicator is displayed.
- 3 To cancel this function, first enter the Set mode by pressing the 0/SET SB button with the FUNC button held depressed, then release the FUNC button and press the 2/DUAL button alone. A "puff" beep tone will be generated to indicate that the normal entry is resumed.

4. Enabling Pager operation utilizing a station with slow signal acceptance

Procedure

- 1 While holding the FUNC button depressed, press the 0/SET SB button to enter the Set mode. (The frequency displays will disappear.)
- 2 Press the 3/PO button. A short beep tone will be generated to indicate that the delay from the moment the PTT button is pressed until the code is transmitted will be changed from 450 ms to 750 ms.
- 3 To cancel this function, first enter the Set mode by pressing the 0/SET SB button with the FUNC button held depressed, then release the FUNC button and press the 3/PO button alone. A "puff" beep tone will be generated to indicate that the normal delay is resumed.

5. Muting short noises during Squelch operation

Procedure

- 1 While holding the FUNC button depressed, press the 0/SET SB button to enter the Set mode. (The frequency displays will disappear.)
- 2 Press the 4/FL DM button. A short beep tone will be generated to indicate that the short noises during Squelch are muted. At this time, slight noise may be heard from the speakers.
- 3 To cancel this function, first enter the Set mode by pressing the 0/SET SB button with the FUNC button held depressed, then release the FUNC button and press the 4/FL DM button alone. A "puff" beep tone will be generated to indicate that the short noises are unmuted.

6. Enabling the Rotary Channel Selector during FL operation

Procedure

- 1 While holding the FUNC button depressed, press the 0/SET SB button to enter the Set mode. (The frequency displays will disappear.)
- 2 Press the 6/STEP button. A short beep tone will be generated to indicate that the frequency can be changed by the Rotary Channel Selector even during Frequency Lock.
- 3 To cancel this function, first enter the Set mode by pressing the 0/SET SB button with the FUNC button held depressed, then release the FUNC button and press the 6/STEP button alone. A "puff" beep tone will be generated to indicate that the normal Function Lock is resumed.

NOTE:

Cancel the Frequency Lock before attempting to set or cancel this function.

16 Changing Frequency During Memory Recall Mode to Initiate New Communication, and Returning to Memory Recall Mode Again

This function allows you to initiate a new communication in the middle of the Memory Recall mode by changing the frequency without canceling the Memory Recall mode.

Procedure

- 1 In the Memory Recall mode, press the # SIFT button with the FUNC starts flashing.
- 2 Vary the desired dial frequency with the Rotary Channel Selector, numeric buttons or ∇/Δ buttons.
- 3 When the desired frequency is set, press the PTT button and communicate at that frequency.
- 4 Press the A/CL button to the previously recalled memory frequency.

Advice

The new frequency can be programmed in the memory address No. by pressing the D V/M ENT button with the FUNC button held depressed after step 2 above.

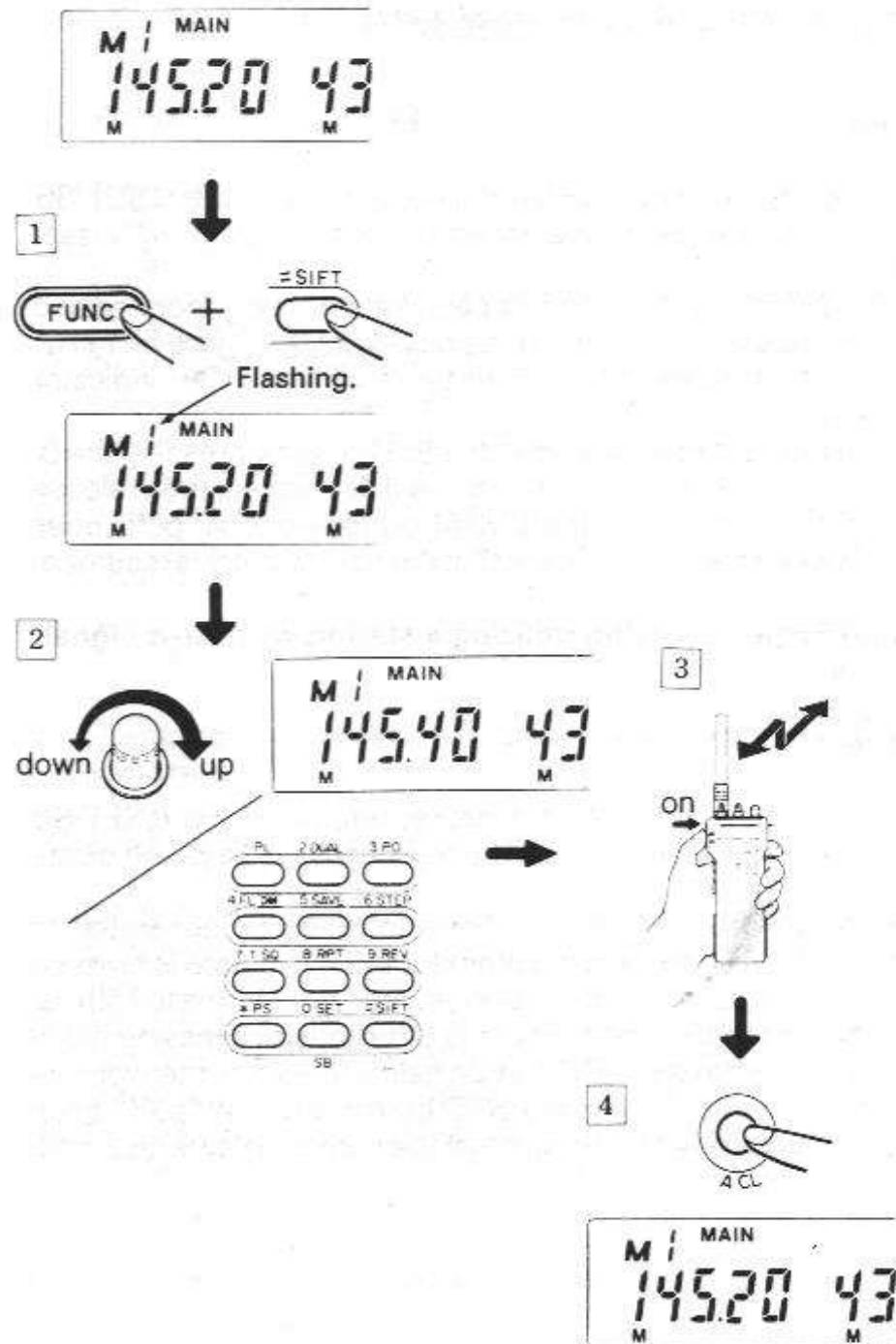

17 Writing the Repeater Mode in a Memory Frequency

Procedure

- 1 Recall the memory address No. where the Repeater mode is to be written.
- 2 While holding the FUNC button depressed, press the 8/RPT button. "T" and "-" will appear on the display, and the tone frequency will become 88.5 Hz and offset frequency become -5 MHz.

18 Changing the Repeater Mode Tone Frequency or Offset Frequency Written in a Memory Frequency

Procedure

- 1 Recall the memory address No. the content of which is to be changed.
- 2 While holding the FUNC button depressed, press the 0/SET SB button to enter the Set mode.
- 3 Press the 7/T.SQ button. When the tone frequency is displayed, rotate the Rotary Channel Selector to select the desired tone frequency.

- 4 Press the A/CL button (this resumes the Memory Recall mode).
- 5 While holding the FUNC button depressed, press the 0/SET SB button to enter the Set mode again.
- 6 Press the 8/RPT button. When the offset frequency is displayed, rotate the Rotary Channel Selector to select the desired offset frequency.
- 7 Press the A/CL button (this resumes the Memory Recall mode). Now the tone frequency and offset frequency setting is complete.
- 8 Similarly, by setting the Tone Squelch operation, Repeater operation while a memory address No. is recalled, their operation conditions can be set in that memory address No.
- 9 When the memory address No. is recalled, "T" and "-" or "T.SQ" are displayed on the display.

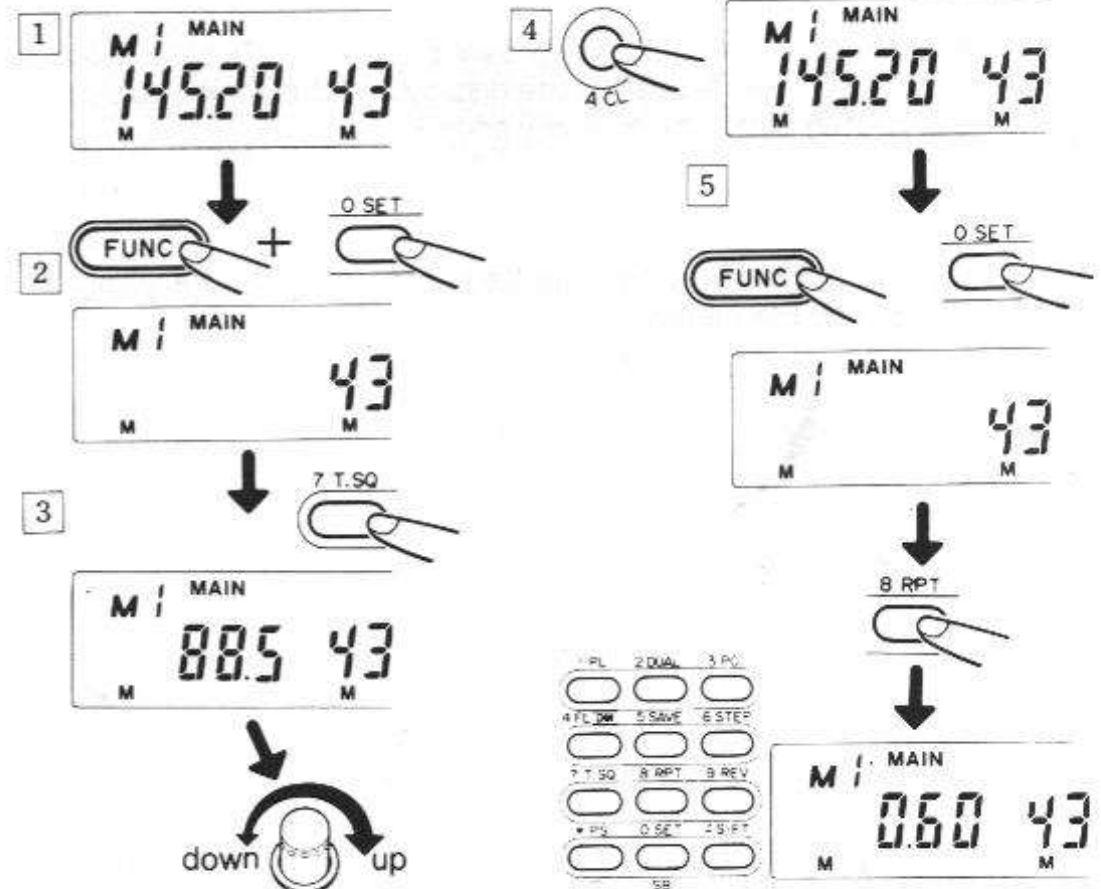

19 Writing the Tone Squelch Mode in a Memory Frequency

This function allows you to write the Tone Squelch mode together with the memory frequency under a memory address No. This function is available when the CTN520 is installed.

Procedure

- 1 Recall the memory address No. where the Tone Squelch mode is to be written.
- 2 While holding the FUNC button depressed, press the 7/T.SQ button twice. A "T.SQ" will appear on the display and the Tone Squelch mode is written under the memory address No.

Advice

For the method of changing the tone frequency, refer to "Recalling/Changing the Tone Frequency".

20 Canceling the Repeater Mode of a Memory Frequency

Procedure

- 1 Recall the memory address No. under which the Repeater mode has been written.
- 2 While holding the FUNC button depressed, press the 7/T.SQ button to extinguish the "T.SQ" indicator. This will cancel the Tone Squelch mode.
- 3 While holding the FUNC button depressed, press the 8/RPT button to extinguish the "+" or "-". This will cancel the Repeater mode.

PAGING FUNCTION

Pager and Code Squelch [B PAG CODE button]

These functions enable you to page one specified station (individual paging) or to page all stations in a group (group paging) over the transceiver.

NOTE:

An individual code (3 figures) and group code (3 figures) must be programmed before operation.

Paging and Code Squelch operations are only available when they are programmed in the memory of each transceiver.

1 Preparation for Paging Operation

Items 1 and 2 below must be prepared before Paging operation.

1. Determine the individual code of your transceiver and program it in memory address No. 3.
2. Determine the group code of the group you belong to and program it in other memory address No. than M0 and M3. Be sure to put "▼" mark to the memory address No. containing the group code.

NOTE:

The Paging operation is only available between transceivers having the assigned individual code or sharing the same group code. The group code must be common for all members of the group.

2 Programming the Individual Code and Group Code in Memory

Both individual and group codes must be a number of 3 figures.

Procedure

Example: To program individual code 234 in memory address M3 and group code 345 in M2

- 1 While pressing the FUNC button depressed, press the B PAG CODE button.
- 2 The frequency display will disappear and be replaced by "0 C000".

The current condition is referred to as the Code display mode.

- 3 When the the Rotary Channel Selector is rotated or the ^ or button is pressed in the Code display mode, the displayed numbers will change in the order from 0, 1, 2, 3, 4, 5, 6 to 0 again. (The initial setting at the factory is "0 C000".
- 4 Display "3" by rotating the Rotary Channel Selector or pressing the ^ or v button, then press numeric buttons "2", "3" and "4". When the last numeric button "4" is pressed, a long beep tone is generated to inform you that the programming of the individual code is complete.
- 5 Display "2" by rotating the Rotary Channel Selector or pressing the ^ or v button, then press numeric buttons "3", "4" and "5". When the last numeric button "5" is pressed, a long beep tone is generated to inform you that the programming of the group code is complete.
- 6 While holding the FUNC button depressed, press the 4/FL button to set the programmed group code. A "▼" mark will be displayed to the left of the figure.

Setting Example

(Station A)	(Station B)	(Station C)	(Station D)
234	XXX	XXX	XXX
100	100	100	100

The individual code must be programmed in address M3.
The group code must be programmed in other address than M0 and M3, and the "▼" mark must be added.

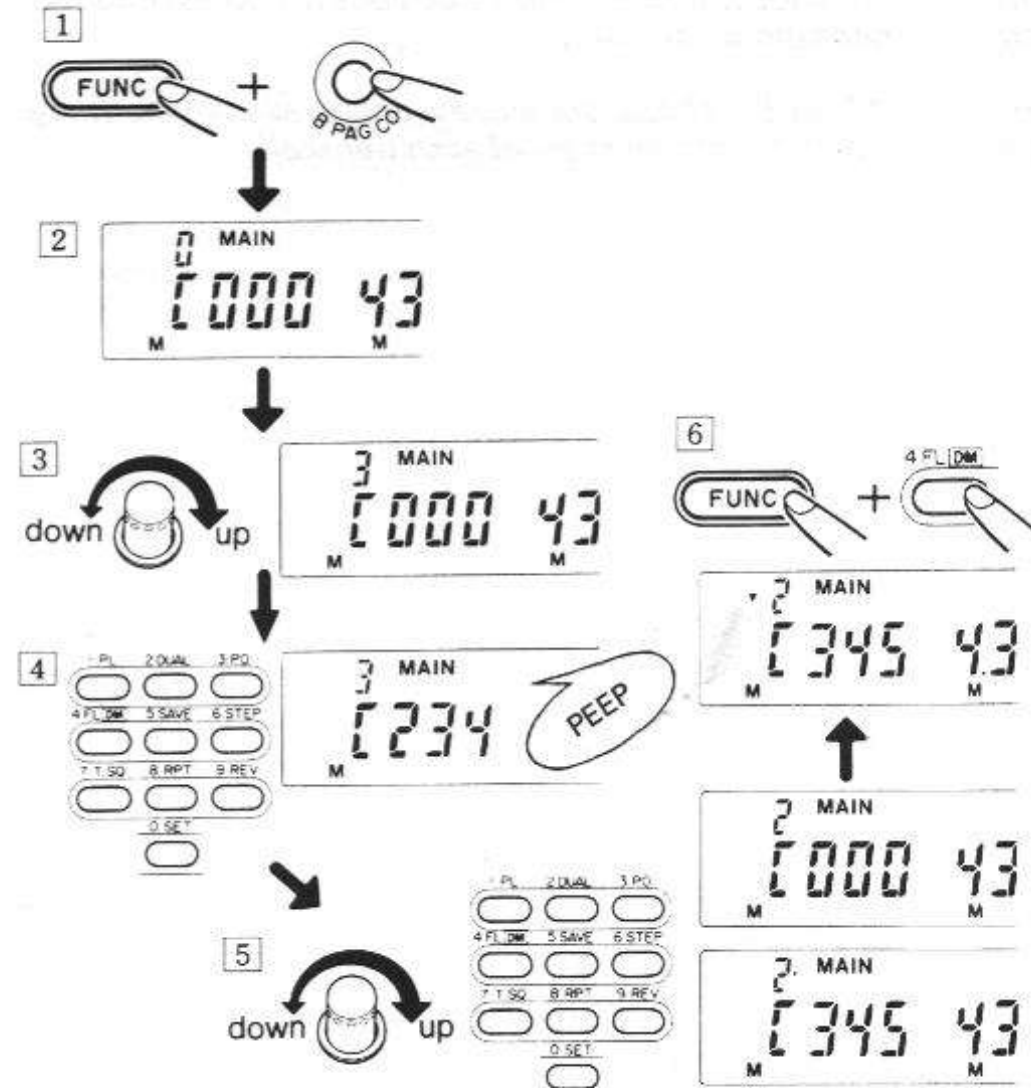

Advice

The three figures of the individual or group code are composed of three DTMF signals from 0 to 9.

The signal composed of three DTMF signals is referred to as the "code".

Memory Address No.	Paging Function (The set code and your station code are transmitted.)
0	Memory for writing the individual code of the remote paging station when your transceiver is paged. In Paging operation, the individual code of the remote station is automatically written here and displayed. Pressing the PTT button in this condition transmits the code being displayed.
1 2	Memory for storing the group code of your transceiver. The receive standby mode is initiated when the "▼" mark is displayed. The code of 1 or 2 is transmitted during communication.
3	Memory for storing the individual code of your transceiver. When your transceiver is paged using your individual code, the individual code of the paging station (in M0) is displayed. Pressing the PTT button in this condition transmits the code being displayed.
4 5 6	Memory for storing the group code of your transceiver. The receive standby mode is initiated when the "▼" mark is displayed. The code of 4, 5 or 6 is transmitted during communication. The "▼" mark indicates the memory address No. in which the group code is programmed. It is possible to set several "▼" marks.

NOTES:

- The "▼" mark can be added to any memory address Nos. However, since M3 is used exclusively for programming the individual code, the code programmed under M3 cannot be turned to the group code even when the "▼" mark is added.
- Group code standby reception is not available if there is no code programmed with the "▼" mark. Therefore, be sure to program a group code with the "▼" mark before attempting group code receive standby. (Refer to the operation examples.)

Operation Examples

- Operation when the following codes are programmed in the memory address Nos.:

Memory Address No.	Code
M0:	_____
M1:	123
▼M2:	234
M3:	345 (Local station code)
M4:	456
▼M5:	567
▼M6:	100

In this example, the local station can receive the paging signal when it is paged by any of the codes except 123 and 456. If the "▼" marks are added to all memory address Nos. except for M3, your transceiver enters the Receive standby mode for six codes.

2. Example (1)

When your transceiver is paged with code 234, "▼2 C234" will appear on the display. This indicates that you are paged with group code 234.

3. Example (2)

When your transceiver is paged with code 567, "▼5 C567" will appear on the display. This indicates that you are paged with group code 567. When your transceiver is paged with code 100, "▼6 C100" will appear on the display. This indicates that you are paged with group code 100.

4. Example (3)

When your transceiver is paged with code 345, "0 CXXX" will appear on the display. This indicates that you are paged with your local station code. (XXX is the individual code of the paging station.)

3 Paging Operation Method

To call a specific station (when its code has already been programmed)

Procedure

In case your transceiver is the paging station

- 1) Program the individual code of the specific station to be paged or, if the code has already been programmed, select the code from the memory.
 - While holding the FUNC button depressed, press the B PAG CODE button.
 - Rotate the Rotary Channel Selector to display memory address Mx (x is a given number).
- 2) Press the D V/M ENT button to set the frequency as the dial frequency.
- 3) Press the B PAG CODE button to enter the Paging mode. A "P" will appear on the display. Pressing the B PAG CODE button in the VFO mode displays a "P" in place of the figure of 100 MHz, pressing again displays a "C" in its place, and pressing once more returns to the VFO mode again.
- 4) Press the PTT button. The DTMF signals will be transmitted automatically (the sound of the DTMF signals are heard). The transmitted DTMF signals are composed of the code of the paged station and individual code of your transceiver.

X X X * X X X

↑ Individual code of your transceiver
↑ Individual or group code of the remote station to be paged.

In case your transceiver is the paged station

Prior to the following operation, the operating frequency to be used must be determined with the remote station.

- 1) Press the B/PAG CODE button to initiate the Paging operation mode. A "P" will appear in place of the figure of 100 MHz on the display.
- 2) When the signal (composed of DTMF signals) which coincides with the code programmed for your transceiver is received, five short-beep tones are generated and "P" on the display starts flashing. Also, the frequency display disappears and the individual code of the remote station appears on the display.
"M0 CXXX" appears when your transceiver is paged with the individual code, or a group code appears when your transceiver is paged with a group code.
When the PTT button is pressed while the "P" is flashing, the code of your transceiver can be transmitted to the remote station.
- 3) Press the B/PAG CODE button to cancel the Paging operation mode before starting communication.

Example of paging between three stations (I)

Code Setting	A	B	C	
0	—	—	—	
1	234	123	123	
2	345	345	234	
3	123	234	345	— Individual codes of the stations
4	▼100	▼100	▼100	— Group code
5	XXX	XXX	XXX	
6	XXX	XXX	XXX	

The setup above makes the following operation possible.

1. When the transceiver of station A enters the Paging mode, displays memory address No. 4 and transmits signal, stations B and C will be paged simultaneously (group paging).
2. When the transceiver of station A enters the Paging mode, displays memory address No. 1 and transmits signal, only station B will be paged (individual paging).

Example of paging between three stations (II)

Code Setting	A	B	C	
0	—	—	—	
1	234	123	123	
2	▼345	345	234	
3	123	234	345	— Individual codes of the stations
4	▼100	▼100	▼100	— Group code
5	XXX	XXX	XXX	
6	XXX	XXX	XXX	

1. When the transceiver of station A enters the Paging mode, displays memory address No. 4 and transmits signal, stations B and C will be paged simultaneously (group paging).
2. When the transceiver of station A enters the Paging mode and starts receive standby, it can receive the pagings using group code 100 or 345 or using individual code 123.
Namely, the transceiver can receive pagings from several stations if several "▼" marks are added.

Advice

- *The beep tone generated when the individual or group code is coincident can be stopped in the middle.
To stop the beep tone in the middle, press the FUNC button.
- *If the individual of the remote station cannot be received completely due to interference, etc., "E" appears on the display informing that the individual code of the remote station is not available.

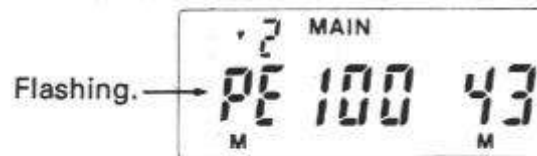

- *The C528 can be paged from models on which the DTMF unit manufactured by STANDARD is installed.
However, with the model C5200/D, the optional CMP830D DTMF Microphone must also be used.
With the model C500, the optional CTD500 DTMF Unit must be used.
With the model C420, the optional CTD120 DTMF Unit must be used.
- *Our DTMF-compatible models C5200/D, C500 and C420 can page the C520, but these models cannot be paged because they are not provided with the Paging function.
- *Our other models C150 and C450 are provided with the Paging function and capable of paging or being paged by the C528. The C112 and C412 become capable of Paging operation provided that the CKP412 Keypad is installed.

4 Code Squelch Operation

The Code Squelch allows a similar operation to the Tone Squelch operation by transmitting a code composed of three figures. The codes used in the memory addresses are used as the signals in the Code Squelch operation. By installing the optional CTN5210 Tone Squelch Unit and using it for the Code Squelch operation, communications with transceivers using the same tone frequency and same code as your transceiver become available.

Code Squelch Operation Procedure

- 1) While holding the FUNC button depressed, press the B/PAG CODE button. Then recall the memory address No. under which the code to be used in Code Squelch operation is programmed.
- 2) Press the D V/M ENT button to initiate the Dial frequency mode.
- 3) Press the B/PAG CODE button twice so that "C" appears in place of the figure of 100 MHz of the frequency display.
- 4) Now the Code Squelch operation using the code selected above will be available.

Advice

Any of memory address Nos. M0 to M6 can be used for Code Squelch operation.

NOTE:

The group code is transmitted for approximately 300 ms. Start communication only after the code has been transmitted.

The C528 incorporates a lithium battery to provide backup power for the microcomputer memory even when the Power switch is turned off. Under normal use, this lithium battery should last for approximately 5 years

Advice

- *When the lithium battery drops below a certain level, the displayed content may become incorrect when the Power switch is turned on. At that time, replace the lithium battery promptly.
- *When the lithium battery has been replaced, turn the Power switch on and press the Reset switch on the side panel of the C528.

NOTES:

- *Be use to use a special lithium battery designed for use with the C528. For the replacement or check of the lithium battery, please consult your dealer or our authorized agency.*
- *After use, do not dispose the battery in fire.*

TROUBLESHOOTING

Q: The frequency display is dim (dark).

A: The whole of the display becomes dim when the batteries are nearly exhausted.
(The battery voltages are low. Replace the batteries with new ones.)

Q: The transceiver returns to the initial condition every time the Power switch is turned on and off.

A: Replace the lithium battery.
When the lithium backup battery is exhausted, the memory circuit become incapable of retaining their information contents.

Q: The power cannot be turned on.

A: Check if the batteries are exhausted.
If they are, replace the batteries.

Q: The displayed frequencies are not correct.

A: The microcomputer may sometimes malfunction after the lithium battery has been replaced.
When the lithium battery has been replaced or when the microcomputer malfunctions, press the Reset switch on the recess on the hand strap side of the transceiver using a thin stick. This will reset the microcomputer.
(Before resetting the microcomputer, turn on the power of the transceiver.)

Q: The frequency display flashes.

A: This occurs when the PLL circuit is unlocked.

Q: The transceiver does not receive signal.

A: Press the SQL OFF button and see if any sound comes out of the speaker.

A: Check if the SQL control is set to the fully clockwise position.
(If they are, rotate the control counterclockwise.)

A: Check if you are mistaking the Volume/SQL controls for the VHF and UHF bands.

This unit is provided with independent Volume/SQL controls for the VHF and UHF bands.

Note that the Volume/SQL controls for the VHF band are located on the left side of the top panel.

The Volume/SQL controls for the UHF band are located on the right.

A: Check if the Tone Squelch operation has been initiated.
(If it has been, cancel it.)

A: Check if the Volume control is set to the fully counterclockwise position.

(If it is, rotate it clockwise to obtain an optimum sound level.)

A: Check if the Paging and Code Squelch operations have been initiated.

(If they have been, cancel them.)

Q: The transceiver appears to receive only the strong signals.

A: Check if the supplied antenna is installed properly.
(If it is not, install it properly.)

A: Check if the SQL control is set to the fully clockwise position.
(If it is, rotate it counterclockwise.)

Weak signals cannot be received if the SQL control is set to the fully clockwise position.

Q: The transceiver does not transmit.

- A: Press the PTT button and check if the transmit indicator lights only dimly.
(If it does, replace batteries.)
- A: Check if "P.L" is shown on the display.
(If it is, press the 1/PL button with the FUNC button held depressed to cancel the PTT Lock.)
- A: Check if the "MAIN" indicator is displayed above the desired band frequency display.
Press the UHF or VHF button so that the MAIN indicator appears above the desired band frequency display.
- A: Check if the TX frequency to be used in the Repeater mode is "OFF-band".
With the "OFF-band" condition, signal cannot be transmitted even when the PTT button is pressed. Set the RX frequency properly.



Q: Communication is not possible.

- A: Check if the transceiver is set for the desired band.
(If not, press the VHF or UHF button to select the desired band.)

Q: Signal cannot be transmitted at the displayed frequency.

- A: Check if "-" or "+" is displayed (flashing) on the display.
(The RX frequency and TX frequency are different in the Repeater operation.)
- A: Check if the MAIN indicator is displayed above the frequency display of the desired band.

Q: The displayed frequency cannot be changed.

- A: Check if the FL indicator is displayed.
(If it is, press the 4/FL button with the FUNC button held depressed to cancel the Frequency Lock.)

Q: No beep tone is generated.

- A: Check if the beep tone has been muted.
(If it has been, press the 0/SET SB button with the FUNC button held depressed to enter the Set mode, then press the 0/SET SB button alone to cancel the muting.)
- A: Check if the Volume control is set to the fully counterclockwise position.
(The beep tone volume varies depending on the Volume control position. Rotate the Volume control to optimize the beep tone volume.)

Q: No information is displayed when the power is turned on.

- A: Auto-Power Off may be initiated.
Press the CALL button or turn the Power switch off then on again to cancel the Auto-Power Off. This will resume the frequencies, etc., on the display.
- A: Check if the batteries are exhausted.

Q: The displayed frequency can be changed only using the Rotary Channel Selector.

- A: Check if the FL indicator is displayed.
(If it is, press the 4/FL button with the FUNC button held depressed to cancel the Frequency Lock.)

OPTIONAL ACCESSORIES

Q: The transceiver cannot access a repeater station.

- A: Check if the transceiver is in the Repeater mode.)
(If not, press the 8/RPT button with the FUNC button held depressed to initiate the Repeater mode.)
- A: Check if the transceiver is using the correct frequency for the desired repeater station.
(If not, set the correct frequency for the repeater station.)
- A: Check if the tone frequency has been set properly (provided that the CTN520 is installed).
- A: Check if you are inside the service area of the repeater station.
- A: Check if "T" is not displayed.
- A: Check if "T.SQ" is not displayed (provided that the CTN520 Tone Squelch Unit is installed).
If the "T.SQ" is displayed, the transceiver is in the Tone Squelch mode. Press the T.SQ button to cancel the Tone Squelch mode.

Q: Dual-Watch does not occur.

- A: Dual-Watch can be performed between the memory frequency and dial frequency. Be sure to program a frequency in the memory before attempting Dual-Watch.

Q: Programmed Scan does not occur.

- A: Programmed Scan can be performed between two memory frequencies. Be sure to program the scan start frequency and end frequency in the memory.

We offer various accessories to increase your communication efficiency.

For proper use of the accessories, please read the owner's manual supplied with them.

- CTN520** : CTCSS (Tone Squelch) Unit
- CNB150** : Compact Rechargeable Battery Pack (7.2 V, 400 mAh)
- CNB151** : Standard Rechargeable Battery Pack (7.2 V, 700 mAh)
- CNB152** : High Power Rechargeable Battery Pack (12 V, 600 mAh)
- CNB153** : Long Life Rechargeable Battery Pack (7.2 V, 1000 mAh)
- CWC150** : AC Charger (for CNB150, CNB151, CNB153)
- CWC151** : AC Charger (for CNB152)
- CSA150** : Desk Top Charger (Quick Charger)
- CAW150** : Power Cable for an automobile
- CMC150** : Mobile Charger (for CNB150, CNB151, CNB153)
- CMB111** : Mobile Bracket
- CLC520** : Standard Size Soft Case (for use when the CNB151 or CBT151 is installed)
- CLC521** : Long Size Soft Case (for use when the CNB152 or CNB153 is installed)
- CBT151** : Battery Tray (for six "AA" size batteries)
- CMP111** : Microphone/Speaker
- CMP112** : Compact Microphone/Speaker
- CHP111** : Head Set with PTT Switch
- CMP113** : Tiepin Microphone
- CAW151** : Power Cable for Base Station
- CAX02** : Bottom Cap

SPECIFICATIONS

• GENERAL

Frequency Ranges	VHF 144 to 147.995 MHz, UHF 430 to 439.995 MHz	
Modulation Type	16F3	
Microphone Input Impedance	600 ohms	
Speaker Impedance	8 ohms	
Operating Voltage Range	6 to 16 V (through external power supply jack)	
Nominal Input Voltage	7.2 V	
Current Drain		
During transmission	13.8 V: Hi (5 W)	app. 1300 mA (UHF) app. 1100 mA (VHF)
	Mid (2.5 W)	app. 1000 mA (UHF) app. 900 mA (VHF)
	7.2 V: Hi (2 W)	app. 1000 mA (UHF) app. 850 mA (VHF)
	Mid (2 W)	app. 1000 mA (UHF) app. 850 mA (VHF)
	13.8/7.2 V: Low (350 mW)	app. 480 mA (UHF) app. 480 mA (VHF)
During Standby	(Twin-band mode)	app. 70 mA
	(Mono-band mode)	app. 45 mA (UHF) app. 36 mA (VHF)
During Battery-Save	(Twin-band mode)	app. 32 mA
	(Mono-band mode)	app. 18 mA (UHF) app. 17 mA (VHF)
Auto-Power Off (APO)		app. 1 mA
Dimensions	55(Width)157(Height)31(Depth)(mm)	
Weight	450 grams (including antenna and batteries)	

• RECEIVER

Reception type	Double-Conversion Superheterodyne
Intermediate Frequencies	VHF: First IF 21.8 MHz, Second IF 455 kHz UHF: First IF 23.05 MHz, Second IF 455 kHz
Sensitivity	-10 dB (-16 dB μ with JAIA method)
S/N at 1 μ V input	30 dB or better
Squelch Sensitivity	-14 dB
Audio Output Power	200 mW (10% distortion, 8 ohms)

• TRANSMITTER

RF Output Power		
Hi: with CBT151:		2.0 W (UHF), 2.4 W (VHF)
with CNB151/153:		2.5 W (UHF), 2.8 W (VHF)
with CNB152:		5.0 W (UHF), 5.0 W (VHF)
Mid: with CBT151:		1.8 W (UHF), 2.3 W (VHF)
with CNB151/153:		2.5 W (UHF), 2.5 W (VHF)
with CNB152:		2.5 W (UHF), 2.5 W (VHF)
Low:		0.35 (UHF/VHF)
Frequency Modulation Method	Reactance	
Maximum Frequency Deviation	\pm 5 kHz	
Spurious Ratio	-60 dB or better	
Built-in Microphone	Electret capacitor microphone	