



FT-950

Technical supplement

©2010 VERTEX STANDARD CO., LTD.

EH031H90D

VERTEX STANDARD CO., LTD.

4-8-8 Nakameguro, Meguro-Ku, Tokyo 153-8644, Japan

VERTEX STANDARD

US Headquarters

10900 Walker Street, Cypress, CA 90630, U.S.A.

YAESU UK LTD.

Unit 12, Sun Valley Business Park, Winnall Close
Winchester, Hampshire, SO23 0LB, U.K.

VERTEX STANDARD HK LTD.

Unit 5, 20/F., Seaview Centre, 139-141 Hoi Bun Road,
Kwun Tong, Kowloon, Hong Kong

VERTEX STANDARD (AUSTRALIA) PTY., LTD.

Normanby Business Park, Unit 14/45 Normanby Road
Notting Hill 3168, Victoria, Australia



Introduction

This manual provides technical information necessary for servicing the FT-950 HF/50 MHz Transceiver.

Servicing this equipment requires expertise in handling surface-mount chip components. Attempts by non-qualified persons to service this equipment may result in permanent damage not covered by the warranty, and may be illegal in some countries. Two PCB layout diagrams are provided for each double-sided circuit board in the Transceiver. Each side of is referred to by the type of the majority of components installed on that side ("leaded" or "chip-only"). In most cases one side has only chip components, and the other has either a mixture of both chip and leaded components (trimmers, coils, electrolytic capacitors, ICs, etc.), or leaded components only.

While we believe the technical information in this manual to be correct, VERTEX STANDARD assumes no liability for damage that may occur as a result of typographical or other errors that may be present. Your cooperation in pointing out any inconsistencies in the technical information would be appreciated.

Contents

Introduction

Specifications

Exploded View

Block Diagram

Connection Diagram

WIRE ASSY List

Alignment

Board Unit (Schematics, Layouts & Parts)

MAIN Unit

CNTL Unit

LOCAL Unit

PA-A Unit

TUNER Unit

DSP Unit/DSP2 Unit

SW-A Unit

SW-B Unit

VR-A Unit

VR-B Unit

PHONE Unit

MIC Unit

KEY Unit

DVS-6 Unit (Option)

Important Note

This transceiver was assembled using Pb (lead) free solder, based on the RoHS specification.

Only lead-free solder (Alloy Composition: Sn-3.0Ag-0.5Cu) should be used for repairs performed on this apparatus. The solder stated above utilizes the alloy composition required for compliance with the lead-free specification, and any solder with the above alloy composition may be used.

Specifications

General

Rx Frequency Range:	30 kHz - 56 MHz (operating) 160 - 6 m (specified performance, Amateur bands only)
Tx Frequency Ranges:	160 - 6 m (Amateur bands only)
Frequency Stability:	±0.5 ppm (after 1 minute @+77 °F [+25 °C]) ±1.0 ppm (after 1 minute @+14 °F ~ +122 °F [-10 °C ~ +50 °C])
Operating Temperature Range:	14 °F ~ +122 °F (-10 °C ~ +50 °C)
Emission Modes:	A1A (CW), A3E (AM), J3E (LSB, USB), F3E (FM), F1B (RTTY), F1D (PACKET), F2D (PACKET)
Frequency Steps:	1/10 Hz (SSB, CW, & AM), 100 Hz (FM)
Antenna Impedance:	50 Ohms, unbalanced 16.7 - 150 Ohms, unbalanced (Tuner ON, 160 - 6 m Amateur bands, TX only)
Power Consumption (Approx.):	Rx (no signal) 1.8 A Rx (signal present) 2.1 A Tx (100 W) 22 A
Supply Voltage:	DC 13.8 V ± 10% (Negative Ground)
Dimensions (WxHxD):	14.4" x 4.5" x 12.4" (365 x 115 x 315 mm)
Weight (Approx.):	21.6 lbs (9.8 kg)

Transmitter

Power Output:	5 - 100 watts (2 - 25 watts AM carrier)
Modulation Types:	J3E (SSB): Balanced, A3E (AM): Low-Level (Early Stage), F3E (FM): Variable Reactance
Maximum FM Deviation:	±5.0 kHz/±2.5 kHz
Harmonic Radiation:	Better than -60 dB (160 - 10m Amateur bands: Harmonics) Better than -50 dB (160 - 10m Amateur bands: Others) Better than -65 dB (6m Amateur band)
SSB Carrier Suppression:	At least 60 dB below peak output
Undesired Sideband Suppression:	At least 60 dB below peak output
3rd-order IMD:	-31 dB @14 MHz 100 watts PEP
Bandwidth:	3 kHz (LSB/USB), 500 Hz (CW), 6 kHz (AM), 16 kHz (FM)
Audio Response (SSB):	Not more than -6 dB from 300 to 2700 Hz
Microphone Impedance:	600 Ohms (200 to 10 kOhms)

Receiver

Circuit Type:	Triple-conversion Superheterodyne															
Intermediate Frequencies:	69.450 MHz/450 kHz/30 kHz (24 kHz for AM/FM)															
Sensitivity:	SSB (BW: 2.4 kHz, 10 dB S+N/N) 4 μ V (0.5 - 1.8 MHz) (IPO "ON") 0.2 μ V (1.8 - 30 MHz) (AMP 2 "ON") 0.125 μ V (50 - 54 MHz) (AMP 2 "ON") AM (BW: 6 kHz, 10 dB S+N/N, 30 % modulation @400 Hz) 28 μ V (0.5 - 1.8 MHz) (IPO "ON") 2 μ V (1.8 - 30 MHz) (AMP 2 "ON") 1 μ V (50 - 54 MHz) (AMP 2 "ON") FM (BW: 15 kHz, 12 dB SINAD) 0.5 μ V (28 - 30 MHz) (AMP 2 "ON") 0.35 μ V (50 - 54 MHz) (AMP 2 "ON") There is no specification for frequency ranges not listed.															
Squelch Sensitivity:	SSB/CW/AM 2 μ V (0.1 - 1.8 MHz) 2 μ V (50 - 54 MHz) FM 1 μ V (28 - 30 MHz) 1 μ V (50 - 54 MHz) There is no specification for frequency ranges not listed.															
Selectivity (WIDTH: Center):	<table><thead><tr><th>Mode</th><th>-6 dB</th><th>-60 dB</th></tr></thead><tbody><tr><td>CW/RTTY/PKT</td><td>0.5 kHz or better</td><td>750 Hz or less</td></tr><tr><td>SSB</td><td>2.4 kHz or better</td><td>3.6 kHz or less</td></tr><tr><td>AM</td><td>6 kHz or better</td><td>15 kHz or less</td></tr><tr><td>FM</td><td>15 kHz or better</td><td>25 kHz or less</td></tr></tbody></table>	Mode	-6 dB	-60 dB	CW/RTTY/PKT	0.5 kHz or better	750 Hz or less	SSB	2.4 kHz or better	3.6 kHz or less	AM	6 kHz or better	15 kHz or less	FM	15 kHz or better	25 kHz or less
Mode	-6 dB	-60 dB														
CW/RTTY/PKT	0.5 kHz or better	750 Hz or less														
SSB	2.4 kHz or better	3.6 kHz or less														
AM	6 kHz or better	15 kHz or less														
FM	15 kHz or better	25 kHz or less														
Image Rejection:	70 dB or better (160 - 10m Amateur bands) 60 dB or better (6m Amateur band)															
Maximum Audio Output:	2.5 W into 4 Ohms with 10% THD															
Audio Output Impedance:	4 to 8 Ohms (4 Ohms: nominal)															
Conducted Radiation:	Less than 4 nW															

Specifications are subject to change, in the interest of technical improvement, without notice or obligation, and are guaranteed only within the amateur bands.

Specifications

Note

REF.	VXSTD P/N	Description	Qty.
①	U31406007	OVAL HEAD SCREW M4X6B	6
②	U20308007	BINDING HEAD SCREW M3X8B	5
③	U24305007	BIND HEAD TAPTITE-B M3X5B	4
④	U31410020	OVAL HEAD SCREW M4X10SUS	2
⑤	U31306007	OVAL HEAD SCREW M3X6B	18
⑥	U24425007	BIND HEAD TAPTITE-B M4X25B (Lot.1-)	2
	U9900254	SPECIAL SCREW M4X20B (Lot.42-)	
⑦	U24410007	BIND HEAD TAPTITE-B M4X10B	2
⑧	U70005002	PLAIN WASHER FW5NI (Lot.1-41)	2

Non-designated parts are available only as part of a designated assembly.

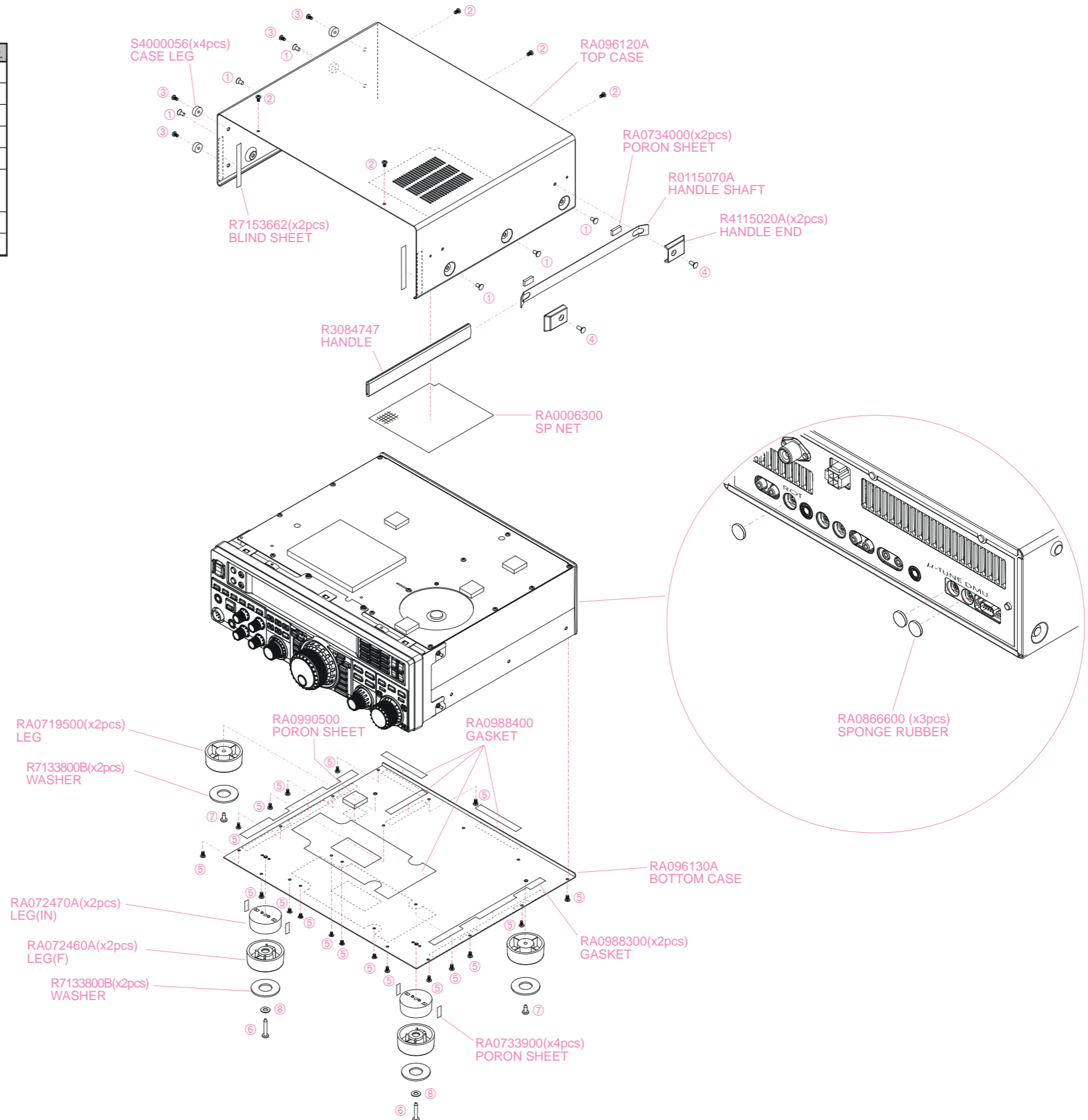

Exploded View

Panel ASSY (1/2)

REF.	VXSTD P/N	Description	Qty.
①	U24306002	BIND HEAD TAPTITE-B M3X6NI(Lot.1-)	16
	U24306001	BIND HEAD TAPTITE-B M3X6(Lot.43-)	
②	U34308001	FLAT HEAD TAPTITE-B M3X8	6

Non-designated parts are available only as part of a designated assembly.

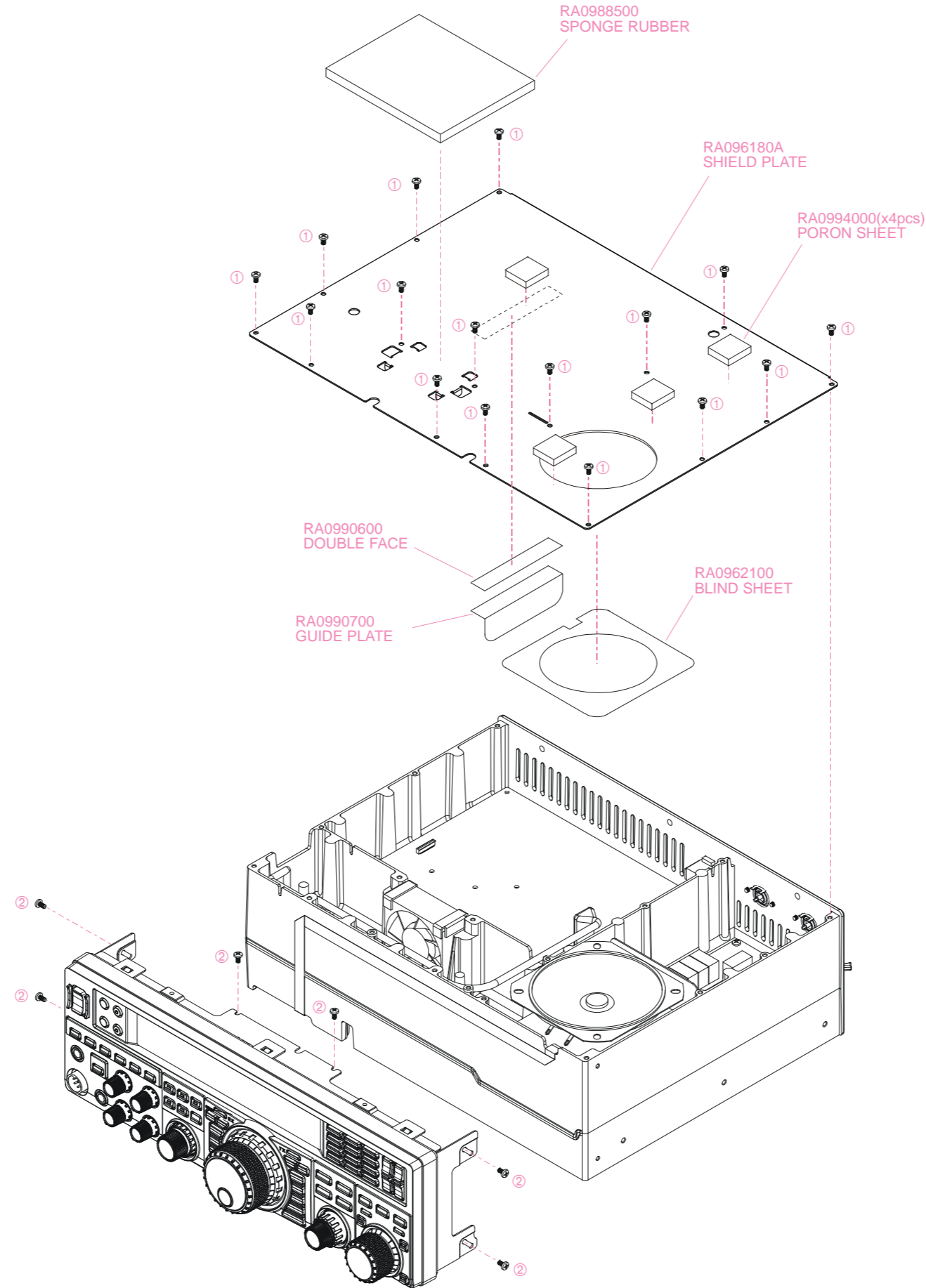

REF.	VXSTD P/N	Description	Qty.
①	U24206001	BIND HEAD TAPTITE-B M2.6X6	9
②	U24105001	BIND HEAD TAPTITE-B M2X5	29

Non-designated parts are available only as part of a designated assembly.

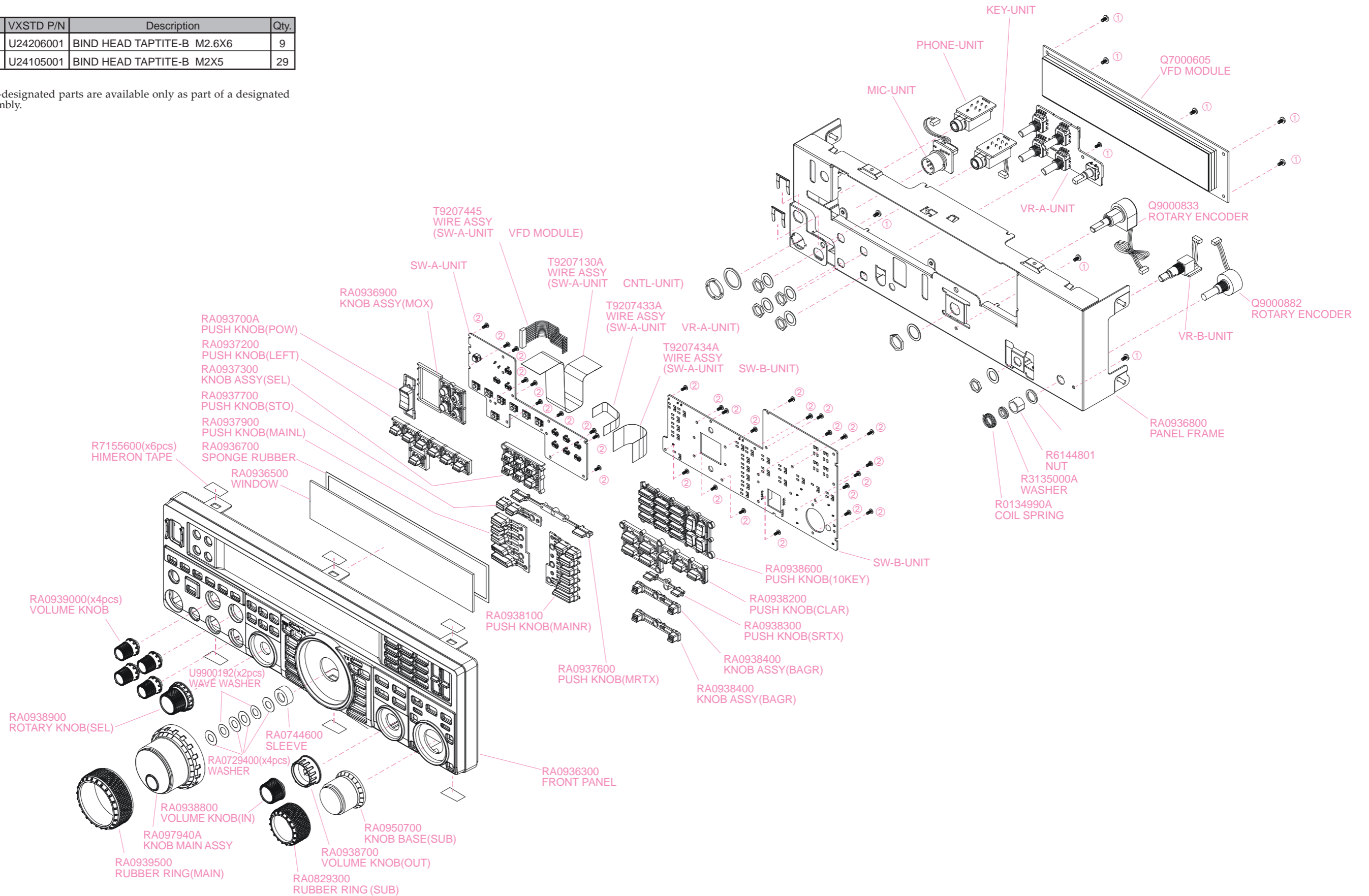

Exploded View

CHASSIS ASSY (1/2)

REF.	VXSTD P/N	Description	Qty.
①	U24306002	BIND HEAD TAPTITE-B M3X6NI(Lot.1-)	4
	U24306001	BIND HEAD TAPTITE-B M3X6(Lot.43-)	
②	U44308002	PAN HEAD TAPTITE-B M3X8NI	4
③	U24306002	BIND HEAD TAPTITE-B M3X6NI(Lot.1-)	19
	U24306001	BIND HEAD TAPTITE-B M3X6(Lot.43-)	
④	U03308002	SEMS SCREW ASM3X8NI	8
⑤	U51525020	HEXA SOCKET BOLT M5X25SUS	1
⑥	U66500002	FLANGE NUT N5NI	1
⑦	U70005002	PLAIN WASHER FW5NI	2
⑧	U72005002	TOOTHED LOCK WASHER OW5NI	2
⑨	U65500102	WING NUT N5NI	1

Non-designated parts are available only as part of a designated assembly.

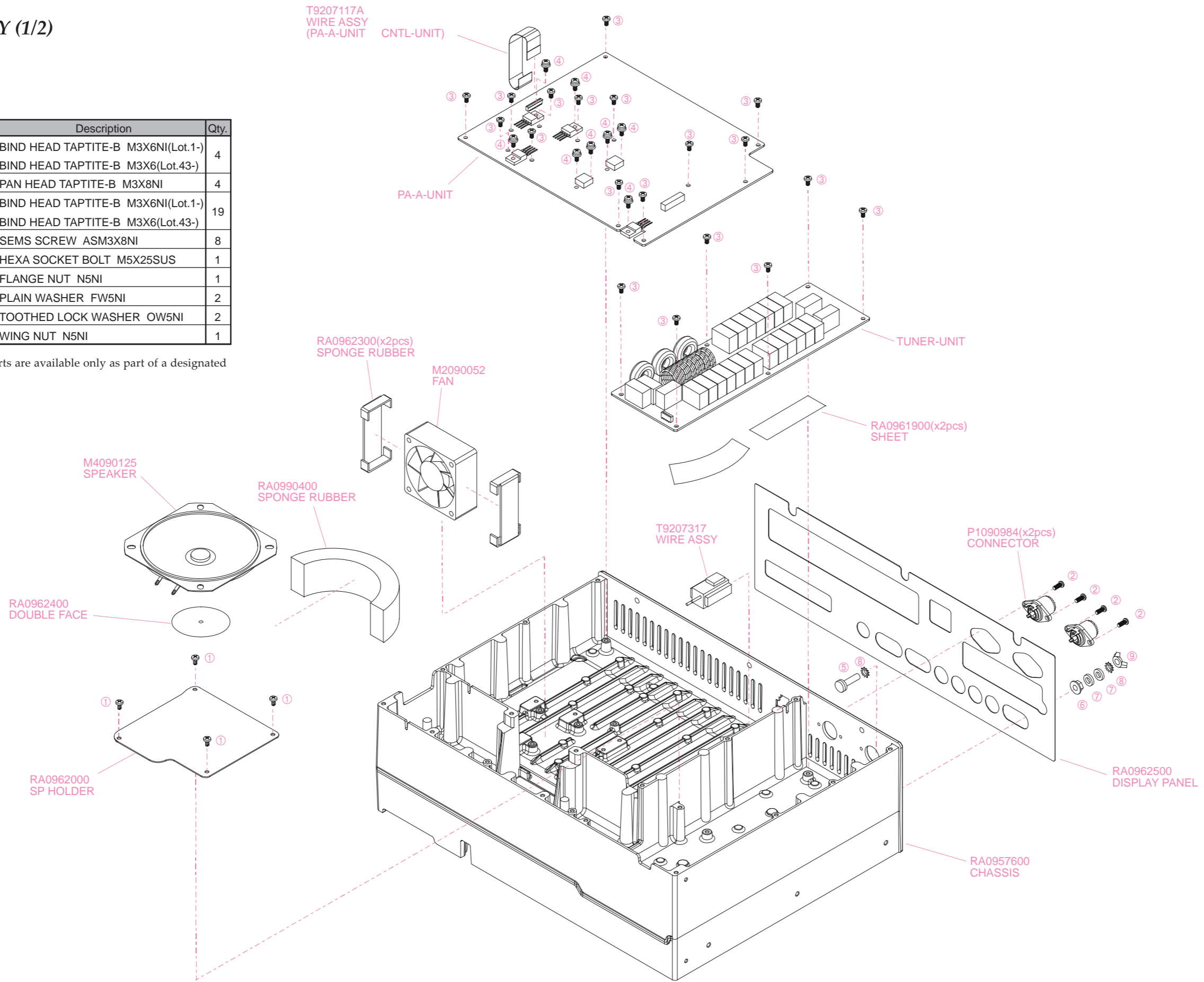

REF.	VXSTD P/N	Description	Qty.
①	U24306002	BIND HEAD TAPTITE-B M3X6NI(Lot.1-)	26
	U24306001	BIND HEAD TAPTITE-B M3X6(Lot.43-)	
②	U44308002	PAN HEAD TAPTITE-B M3X8NI	4
③	U03306002	SEMS SCREWAS M3X6NI	4
④	U72003001	TOOTHED LOCK WASHER OW3	3

Non-designated parts are available only as part of a designated assembly.

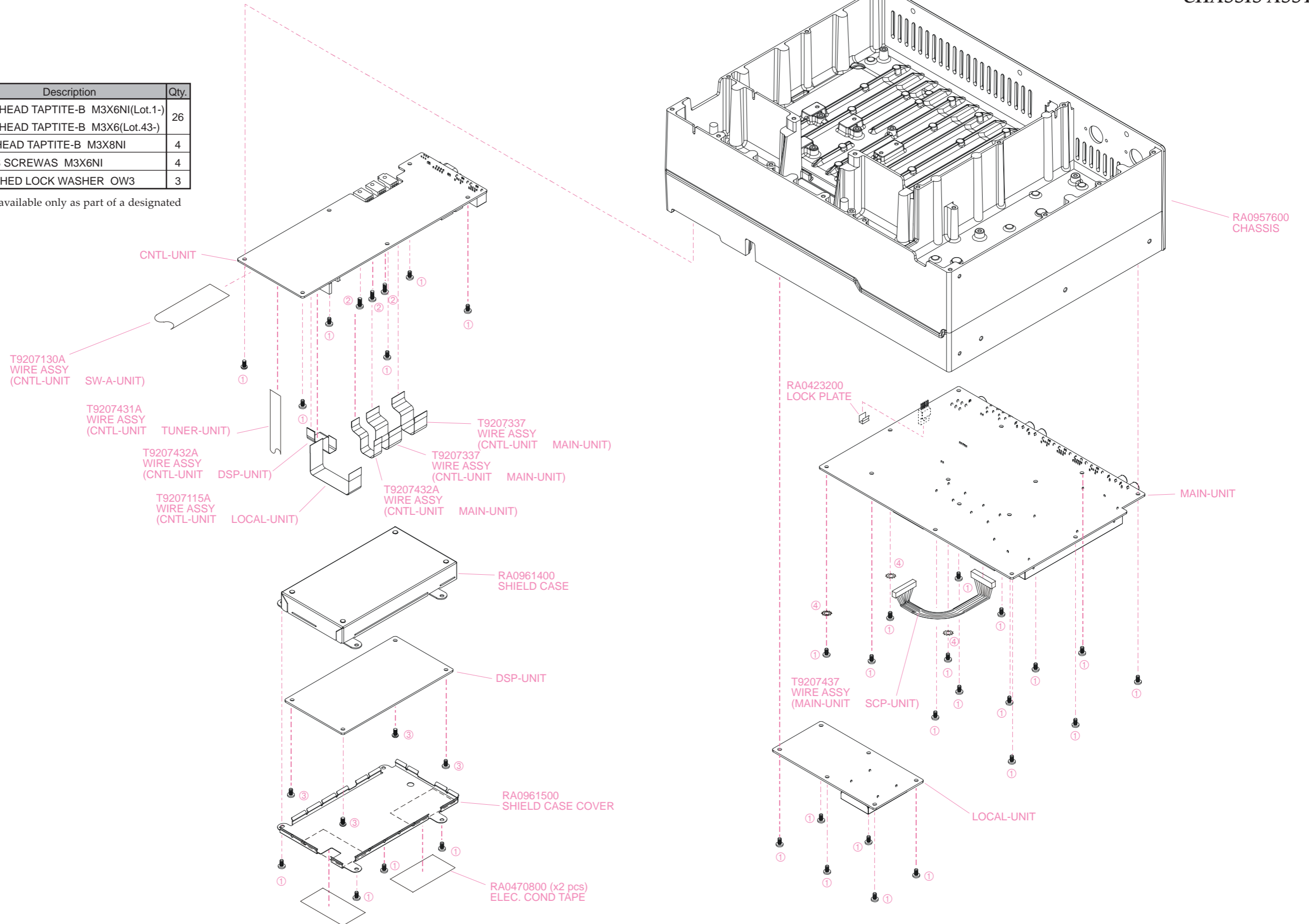

Exploded View

NOTE:

FT-950 BLOCK-DIAGRAM

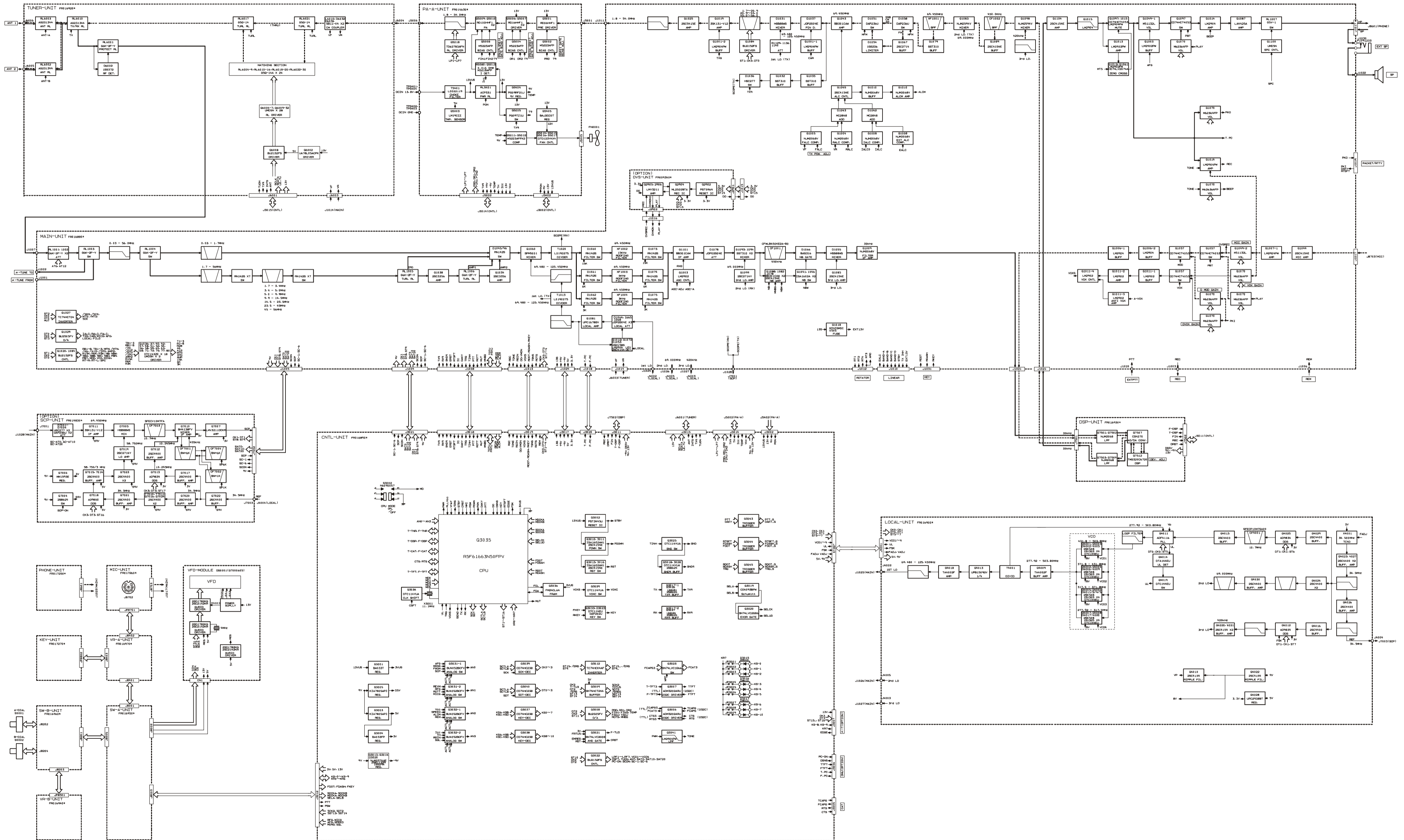

Connection Diagram

CONNECTION DIAGRAM

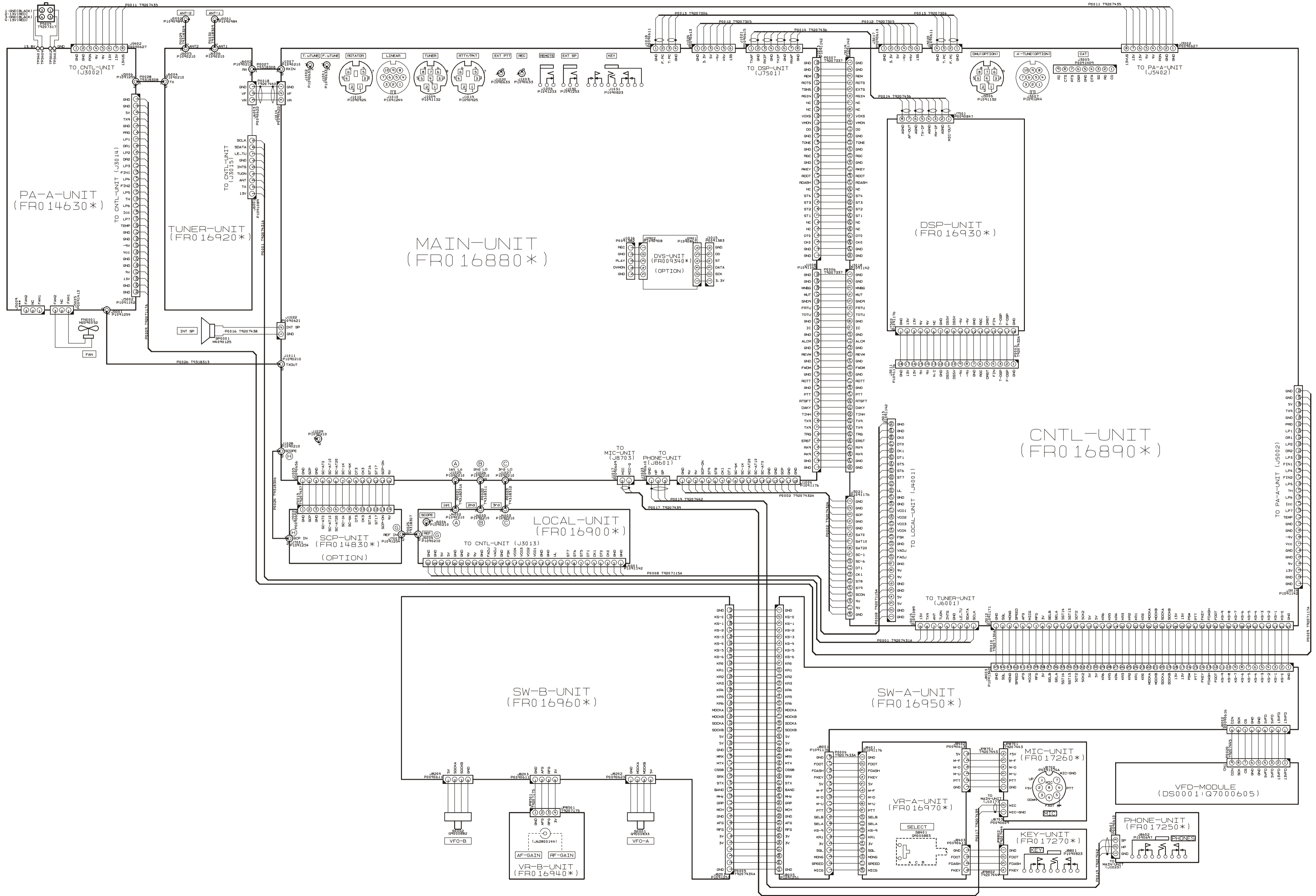

CONNECTION DIAGRAM-1

WIRE ASSY List

Note

Introduction and Precautions

The following procedures cover adjustments that are not normally required once the transceiver has left the factory. However, If a problem occurs during normal operation due to component failure; realignment may be required after the faulty components have been replaced.

We recommend that authorized Vertex Standard Technicians, who are experienced with the circuitry and fully equipped to repair and align our products, perform repairs. If a fault is suspected, contact the selling dealer for instructions regarding repair. Authorized Vertex Standard Technicians have the latest information to align all circuits and make complete performance checks to ensure compliance with factory specifications after repairs.

Those who do undertake any of the following alignments are cautioned and proceed at their own risk. Problems caused by unauthorized attempts at realignment are not covered by the warranty policy.

Vertex Standard must reserve the right to change circuits and alignment procedures in the interest of improved performance, without notifying owners.

Under no circumstances should any alignment be attempted unless the normal functions and operation of the transceiver are clearly understood, the cause of the malfunction has been clearly identified and all faulty components replaced. The need for realignment should be determined to be absolutely necessary.

The following test equipment (and a thorough familiarity with its correct use) is necessary for correct realignment. Most steps do not require all of the equipment listed. The interactions of some adjustments may require that more complex adjustments be performed in a sequence. Do not attempt to perform only a single step unless it is clearly isolated electrically from all other steps. Have all test equipment ready before beginning, and follow all of the steps in a section in the order they are presented.

Important Notice

Do not adjust the alignment menus that are not mentioned in this manual.

Required Test Equipment

- RF Signal Generator
- AF Signal Generator
- Spectrum Analyzer good to at least 1 GHz.
- Frequency Counter
- SINAD Meter
- RF Millivoltmeter
- Electronic Load
- Digital DC Voltmeter (high-Z, 1 M-Ohm/V)
- DC Voltmeter
- DC Ammeter (20 A)
- Ohmmeter
- DMU-2000 Data Management Unit
- 50-Ohm Dummy Load (100 watts)
- In-Line Wattmeter (100 watts, 50-Ohm)
- Linear Detector
- RF Coupler
- 4-Ohm AF Dummy Load (3 watts)
- 1/4-inch 3-contact Plug

Alignment Preparation & Precautions

A 50-ohm RF Dummy load and in-line wattmeter must be connected to the "ANT 1" jack in all procedures that call for transmission, except where specified otherwise. Correct alignment is not possible with an antenna.

After completing one step, read the following step to determine whether the same test equipment will be required. If not, remove the unneeded test equipment before proceeding. (except the dummy load and wattmeter).

Correct alignment requires that the ambient temperature be maintained constant between 68 °F ~ 86 °F (20 °C ~ 30 °C). When the transceiver is brought into the shop from a hot or cold environment, it should be allowed time to come to room temperature before alignment. Also, the test equipment must be thoroughly warmed up before beginning.

Whenever possible, alignments should be made with oscillator shields and circuit boards firmly affixed in place.

Note: Signal levels in dB referred to in this procedure are based on 0 dB μ = 0.5 μ V (closed circuit).

Alignment

VDD Meter Adjustment

- ❑ Connect the DC voltmeter to pin 6 of J5402 on the PA-A Unit.
- ❑ Switch the external display to “SWR Monitor” page.
- ❑ Press and hold in the [1.8(1)], [3.5(2)], and [7(3)] keys, while turning the radio on, to enter the alignment mode.
- ❑ Rotate the Main Tuning Dial knob to select the alignment parameter “B-01 vdd”.
- ❑ Press the [ENT] key, then rotate the [CLAR(VFO-B)] knob so that the VDD meter reading is the same as that on the DC voltmeter.
- ❑ Rotate the Main Tuning Dial knob to select the alignment parameter “B-02 vdd”.
- ❑ Rotate the [CLAR(VFO-B)] knob so that the VDD meter (on the external display) reading is same as that on the DC voltmeter.
- ❑ Press and hold in the [MENU] button for one second to save the new setting and exit the alignment mode.

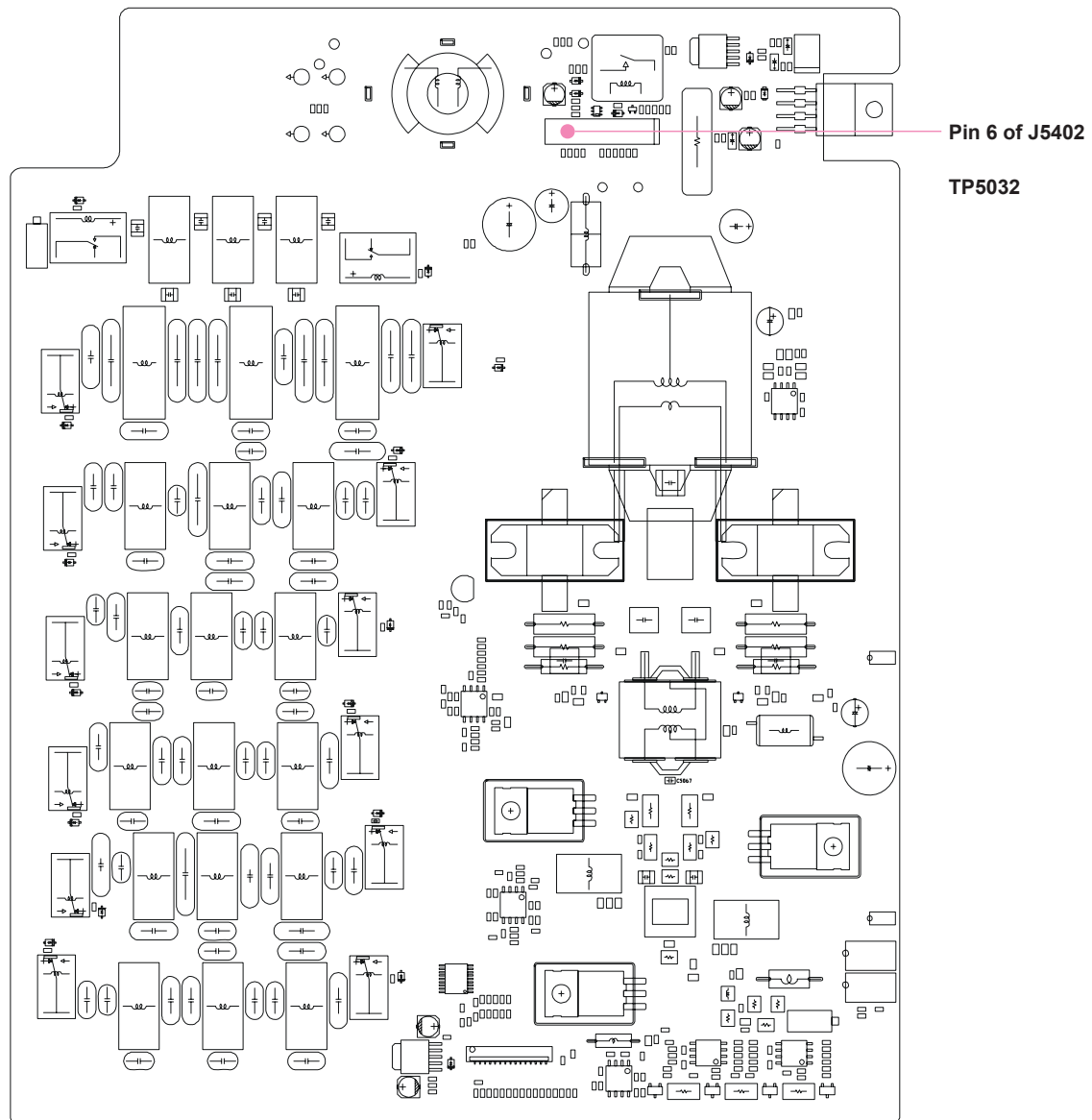

PA-A UNIT ALIGNMENT POINTS

2nd Local Oscillator Adjustment

- ❑ Disconnect the coaxial cable from J4005 on the LOCAL Unit, then connect the Frequency counter to J4005.
- ❑ Press and hold in the [1.8(1)], [3.5(2)], and [7(3)] keys, while turning the radio on, to enter the alignment mode.
- ❑ Rotate the Main Tuning Dial knob to select the alignment parameter “C-08 FrE”.
- ❑ Rotate the [CLAR(VFO-B)] knob so that the Frequency counter reading is “69.000 MHz”.
- ❑ Press and hold in the [MENU] button for one second to save the new setting and exit the alignment mode.
- ❑ Disconnect the Frequency counter from J4005, then connect the RF millivoltmeter to J4005.
- ❑ Adjust T4003, T4004, and T4005 on the LOCAL Unit for maximum deflection on the RF millivoltmeter (more than 0 dBm).
- ❑ Disconnect the RF millivoltmeter from J4005, then re-connect the coaxial cable to J4005.

PLL Adjustment

- ❑ Connect the Digital DC voltmeter (high-Z) to TP4005 on the LOCAL Unit.
- ❑ Disconnect the coaxial cable from J4002 on the LOCAL Unit, then connect the RF millivoltmeter to J4002.
- ❑ Press and hold in the [1.8(1)], [3.5(2)], and [7(3)] keys, while turning the radio on, to enter the alignment mode.
- ❑ Referring to the table below, select the appropriate “Alignment Parameter” using the Main Tuning Dial knob per the chart below, and adjust the listed components for the required voltage, or confirm that the correct voltage is present on each alignment parameter.

ALIGNMENT PARAMETER	ADJUST / CONFIRM	DC VOLTMETER	RF MILLIVOLTMETER
A-01 V1H	Adjust TC4004	5.0 V \pm 0.1 V	At least -3 dBm
A-02 V1L	Confirm	At least 0.7 V	At least -3 dBm
A-03 V2H	Adjust TC4003	5.0 V \pm 0.1 V	At least -3 dBm
A-04 V2L	Confirm	At least 0.7 V	At least -3 dBm
A-05 V3H	Adjust TC4002	5.0 V \pm 0.1 V	At least -3 dBm
A-06 V3L	Confirm	At least 0.7 V	At least -3 dBm
A-07 V4H	Adjust TC4001	5.0 V \pm 0.1 V	At least -3 dBm
A-08 V4L	Confirm	At least 0.7 V	At least -3 dBm

- ❑ Disconnect the RF millivoltmeter from J4002, then re-connect the coaxial cable to J4002.
- ❑ Press and hold in the [MENU] button for one second to save the new setting and exit the alignment mode.

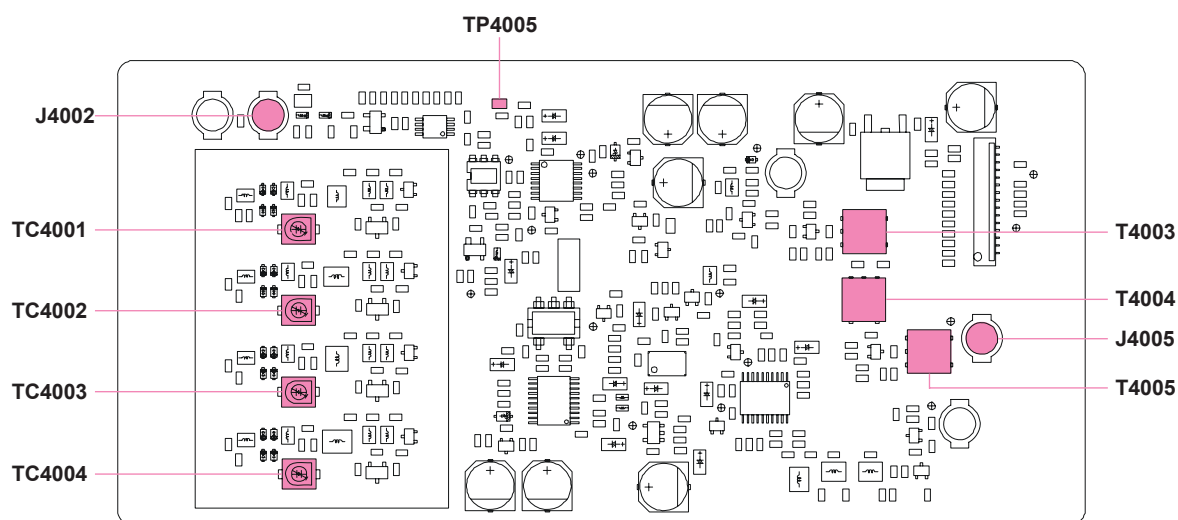

LOCAL UNIT ALIGNMENT POINTS

Alignment

Main Receiver Adjustment

1st Local Oscillator Adjustment

- ❑ Set the following controls as indicated:
 - [ANT 1-2] button: ANT 1
 - [IPO] button: AMP1
 - [ATT] button: OFF
 - [μ-TUNE] button: THRU
 - [R.FLT] button: AUTO
 - [AGC] button: AUTO
 - [RF GAIN] knob: Fully clockwise
 - [MODE] button: CW
- ❑ Connect the RF millivoltmeter to TP1049 on the MAIN Unit.
- ❑ Press and hold in the [1.8(1)], [3.5(2)], and [7(3)] keys, while turning the radio on, to enter the alignment mode.
- ❑ Rotate the Main Tuning Dial knob to select the alignment parameter "C-03 L7".
- ❑ Rotate the [CLAR(VFO-B)] knob so that the RF millivoltmeter reading is "1.0 Vrms ±0.05 V", then press the [ENT] key.
- ❑ Rotate the Main Tuning Dial knob to select the alignment parameter "C-04 L14".
- ❑ Rotate the [CLAR(VFO-B)] knob so that the RF millivoltmeter reading is "0.6 Vrms ±0.05 V", then press the [ENT] key.
- ❑ Rotate the Main Tuning Dial knob to select the alignment parameter "C-07 L50".
- ❑ Rotate the [CLAR(VFO-B)] knob so that the RF millivoltmeter reading is "0.7 Vrms ±0.05 V", then press the [ENT] key.
- ❑ Press and hold in the [MENU] button for one second to save the new settings and exit the alignment mode.

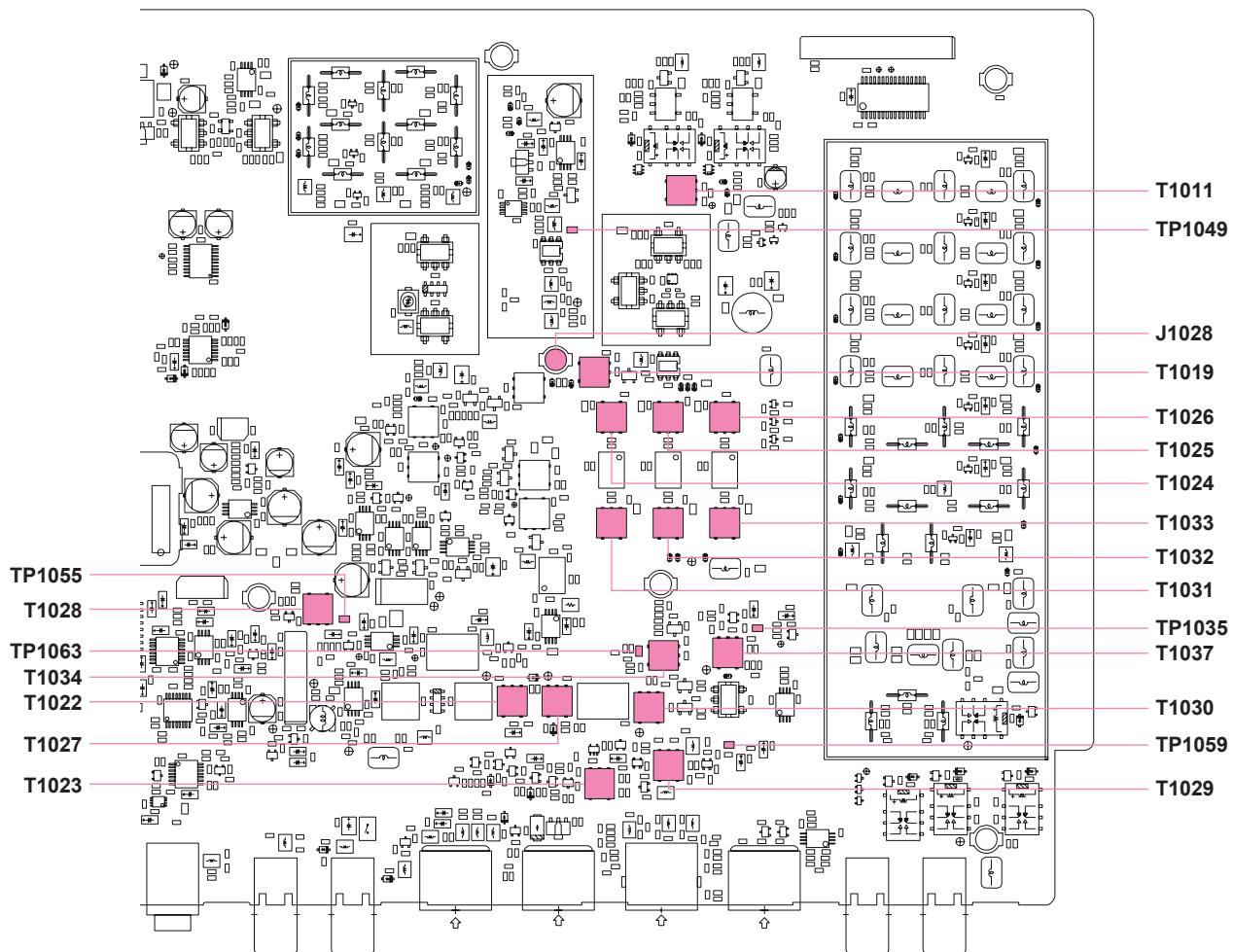

MAIN UNIT (RECEIVER SECTION) ALIGNMENT POINTS

2nd/3rd Local Level Adjustment

- ❑ Connect the RF millivoltmeter to TP1063 on the MAIN Unit.
- ❑ Adjust T1034 on the MAIN Unit for maximum deflection on the RF millivoltmeter (more than +8 dBm).
- ❑ Connect the RF millivoltmeter to TP1055 on the MAIN Unit.
- ❑ Adjust T1028 on the MAIN Unit for maximum deflection on the RF millivoltmeter (more than 0 dBm).

IF Transformer Adjustment

- ❑ Set the VFO-A frequency to 14.200 MHz in the CW mode.
- ❑ Set the following controls as indicated:
 - [ANT 1-2] button: ANT 1
 - [IPO] button: AMP1
 - [ATT] button: OFF
 - [μ-TUNE] button: THRU
 - [R.FLT] button: 6 kHz
 - [AGC] button: AUTO
 - [RF GAIN] knob: Fully clockwise
- ❑ Connect the AF millivoltmeter and 4 Ohm dummy load to the EXT SP jack.
- ❑ Connect the RF Signal Generator to the “ANT 1” jack, then set the output level to 0 dBμ at the 14.200 MHz.
- ❑ Adjust T1025, T1032, T1037, T1030, T1027, and T1022 on the MAIN Unit in succession several times for maximum deflection on the AF millivoltmeter.

Note: 1) If the S-meter deflects while adjusting, reduce the RF Signal Generator output so that the S-meter does not deflect.

2) There are two peak points in the T1025 and T1032 adjustments. Adjust T1025 and T1032 so the cores are in the upper part of the coil.

MCF Adjustment (1)

- ❑ Set the VFO-A frequency to 14.200 MHz in the CW mode.
- ❑ Set the following controls as indicated:
 - [ANT 1-2] button: ANT 1
 - [IPO] button: AMP1
 - [ATT] button: OFF
 - [μ-TUNE] button: THRU
 - [R.FLT] button: 3 kHz
 - [AGC] button: AUTO
 - [RF GAIN] knob: Fully clockwise
- ❑ Connect the AF millivoltmeter and 4 Ohm dummy load to the EXT SP jack.
- ❑ Connect the RF Signal Generator to the “ANT 1” jack, then set the output level to 0 dBμ at the 14.200 MHz.
- ❑ Adjust T1026 and T1033 on the MAIN Unit in succession several times for maximum deflection on the AF millivoltmeter.

Note: 1) If the S-meter deflects while adjusting, reduce the RF Signal Generator output so that the S-meter does not deflect.

2) There are two peak points in the T1026 and T1033 adjustments. Adjust T1026 and T1033 so the cores are in the upper part of the coil.

IF Trap Adjustment

- ❑ Set the VFO-A frequency to 50.000 MHz in the CW mode.
- ❑ Set the following controls as indicated:
 - [ANT 1-2] button: ANT 1
 - [IPO] button: AMP1
 - [ATT] button: OFF
 - [μ-TUNE] button: THRU
 - [R.FLT] button: AUTO
 - [AGC] button: AUTO
 - [RF GAIN] knob: Fully clockwise
- ❑ Connect the AF millivoltmeter and 4 Ohm dummy load to the EXT SP jack.
- ❑ Connect the RF Signal Generator to the “ANT 1” jack, then set the output level to +60 ~ +90 dBμ at the 69.450 MHz.
- ❑ Adjust T1011 on the MAIN Unit for minimum deflection on the AF millivoltmeter.

Note: If the S-meter deflects while adjusting, reduce the RF Signal Generator output so that the S-meter does not deflect.

Alignment

MCF Adjustment (2)

- ❑ Press and hold in the [1.8(1)], [3.5(2)], and [7(3)] keys, while turning the radio on, to enter the alignment mode.
- ❑ Rotate the Main Tuning Dial knob to select the alignment parameter “G-03 FnG”.
- ❑ Rotate the [CLAR(VFO-B)] knob so that the Multi-Display Window shows “80”.
- ❑ Press and hold in the [MENU] button for one second to save the new setting and exit the alignment mode.
- ❑ Set the VFO-A frequency to 50.000 MHz in the FM mode.
- ❑ Set the following controls as indicated:
 - [ANT 1-2] button: ANT 1
 - [IPO] button: AMP2
 - [ATT] button: OFF
 - [μ-TUNE] button: THRU
 - [R.FLT] button: 15 kHz
 - [AGC] button: AUTO
 - [RF GAIN] knob: Fully clockwise
- ❑ Connect the SINAD meter and 4 Ohm dummy load to the EXT SP jack.
- ❑ Connect the RF Signal Generator to the “ANT 1” jack, then set the output level to $-10 \sim 0$ dBμ at the 50.000 MHz with ± 3.5 kHz deviation FM modulation of a 1 kHz audio signal.
- ❑ Adjust T1024 and T1031 on the MAIN Unit in succession several times for maximum deflection on the SINAD meter.
- ❑ Adjust T1022 on the MAIN Unit in succession several times for maximum deflection on the SINAD meter.
Note: Do not adjust T1022 more than 45 degrees rotation.

Noise Blanker Circuit Adjustment

- ❑ Set the VFO-A frequency to 14.200 MHz in the CW mode.
- ❑ Set the following controls as indicated:
 - [ANT 1-2] button: ANT 1
 - [IPO] button: AMP1
 - [ATT] button: OFF
 - [μ-TUNE] button: THRU
 - [R.FLT] button: AUTO
 - [AGC] button: AUTO
 - [NB] button: ON (for short-duration pulse noise)
 - [RF GAIN] knob: Fully clockwise
- ❑ Connect the Digital DC voltmeter (high-Z) to TP1059 on the MAIN Unit.
- ❑ Connect the RF Signal Generator to the “ANT 1” jack, then set the output level to 30 dBμ at 14.200 MHz.
- ❑ Adjust T1029 and T1023 on the MAIN Unit for minimum deflection on the DC voltmeter.
- ❑ Turn the NB to “OFF” by pressing the [NB] button.

Scope Circuit Adjustment

- ❑ Set the VFO-A frequency to 14.200 MHz in the CW mode.
- ❑ Set the following controls as indicated:
 - [ANT 1-2] button: ANT 1
 - [IPO] button: AMP1
 - [ATT] button: OFF
 - [μ-TUNE] button: THRU
 - [R.FLT] button: AUTO
 - [AGC] button: AUTO
 - [RF GAIN] knob: Fully clockwise
- ❑ Disconnect the coaxial cable from J1028 on the MAIN Unit, then connect the RF millivoltmeter to J1028.
- ❑ Connect the RF Signal Generator to the “ANT 1” jack, then set the output level to 80 dBμ at 14.200 MHz.
- ❑ Adjust T1019 on the MAIN Unit for maximum deflection on the RF millivoltmeter.
- ❑ Disconnect the RF millivoltmeter from J1028, then re-connect the coaxial cable to J1028.

RF AGC Adjustment

- ❑ Set the following controls as indicated:
 [ANT 1-2] button: ANT 1
 [IPO] button: AMP1
 [ATT] button: OFF
 [μ -TUNE] button: THRU
 [R.FLT] button: 6 kHz
 [AGC] button: AUTO
 [RF GAIN] knob: Fully clockwise
 [MODE] button: CW
- ❑ Connect the Digital DC voltmeter (high-Z) to TP1035 on the MAIN Unit.
- ❑ Press and hold in the [1.8(1)], [3.5(2)], and [7(3)] keys, while turning the radio on, to enter the alignment mode.
- ❑ Rotate the Main Tuning Dial knob to select the alignment parameter "D-05 rGc".
- ❑ Note the Digital DC voltmeter reading (with no receive signal).
- ❑ Rotate the [CLAR(VFO-B)] knob counter-clockwise just to the point where the Digital DC voltmeter reading is 0.01 V less than the voltage noted in the previous step.
- ❑ Rotate the [CLAR(VFO-B)] knob clockwise just to the point where the Digital DC voltmeter reading is the same as the previously noted voltage, then press the [ENT] key.
- ❑ Press and hold in the [MENU] button for one second to save the new setting and exit the alignment mode.

IF Gain Adjustment

- ❑ Set the VFO-A frequency to 1.900 MHz in the CW mode.
- ❑ Set the following controls as indicated:
 [ANT 1-2] button: ANT 1
 [IPO] button: AMP1
 [ATT] button: OFF
 [μ -TUNE] button: THRU
 [R.FLT] button: 6 kHz
 [AGC] button: AUTO
 [RF GAIN] knob: Fully clockwise
 [MODE] button: CW
- ❑ Set the CW PITCH frequency to "700 Hz" via Menu item "045 A1A PITCH".
- ❑ Connect the AF millivoltmeter and 4 Ohm dummy load to the EXT SP jack.
- ❑ Connect the RF Signal Generator to the "ANT 1" jack, then set the output level to 36 dB μ at 1.900 MHz.
- ❑ Press and hold in the [1.8(1)], [3.5(2)], and [7(3)] keys, while turning the radio on, to enter the alignment mode.
- ❑ Adjust the Main [AF GAIN] knob so that the AF millivoltmeter reading is "0 dB."
- ❑ Refer to the chart below and select the appropriate "Alignment Parameter" using the Main Tuning Dial knob per the chart below, then set the RF Signal Generator output to each frequency & level, and adjust the [CLAR(VFO-B)] knob for the corresponding AC millivoltmeter reading at each frequency.

ALIGNMENT PARAMETER	RF SIGNAL GENERATOR	VFO-A FREQUENCY	AF MILLIVOLTMETER
E-01 iGn	1.900 MHz, 9 dB μ	1.900 MHz	-1.5 dB (± 0.5 dB)
E-02 iGn	3.750 MHz, 9 dB μ	3.750 MHz	-1.5 dB (± 0.5 dB)
E-03 iGn	7.150 MHz, 9 dB μ	7.150 MHz	-1.5 dB (± 0.5 dB)
E-04 iGn	10.125 MHz, 9 dB μ	10.125 MHz	-1.5 dB (± 0.5 dB)
E-05 iGn	14.175 MHz, 9 dB μ	14.175 MHz	-1.5 dB (± 0.5 dB)
E-06 iGn	18.117 MHz, 9 dB μ	18.117 MHz	-1.5 dB (± 0.5 dB)
E-07 iGn	21.255 MHz, 9 dB μ	21.255 MHz	-1.5 dB (± 0.5 dB)
E-08 iGn	24.940 MHz, 9 dB μ	24.940 MHz	-1.5 dB (± 0.5 dB)
E-09 iGn	28.850 MHz, 9 dB μ	28.850 MHz	-1.5 dB (± 0.5 dB)
E-10 iGn	52.000 MHz, 9 dB μ	52.000 MHz	-1.5 dB (± 0.5 dB)

- ❑ Press and hold in the [MENU] button for one second to save the new settings and exit the alignment mode.

Alignment

S-meter Adjustment

- ❑ Set the VFO-A frequency to 14.200 MHz in the CW mode.
- ❑ Set the following controls as indicated:
 [ANT 1-2] button: ANT 1
 [IPO] button: AMP1
 [ATT] button: OFF
 [μ -TUNE] button: THRU
 [R.FLT] button: 6 kHz
 [AGC] button: AUTO
 [RF GAIN] knob: Fully clockwise
- ❑ Connect the RF Signal Generator to the “ANT 1” jack, then set the frequency to 14.200 MHz.
- ❑ Press and hold in the [1.8(1)], [3.5(2)], and [7(3)] keys, while turning the radio on, to enter the alignment mode.
- ❑ Refer to the chart below and select the appropriate “Alignment Parameter” using the Main Tuning Dial knob. Set the RF Signal Generator output to each level, and adjust the [CLAR(VFO-B)] knob for the corresponding S-meter reading. Press the [ENT] key to save the new setting at each level.

ALIGNMENT PARAMETER	RF SIGNAL GENERATOR	MAIN S-METER
F-01 S-0	11 dB μ	Turn on one dot
F-02 S-1	13 dB μ	S-1
F-03 S-5	24 dB μ	S-5
F-04 S-7	30 dB μ	S-7
F-05 S-9	36 dB μ	S-9
F-06 S10	46 dB μ	S-9+10dB
F-07 S20	56 dB μ	S-9+20dB
F-08 S30	66 dB μ	S-9+30dB
F-09 S40	76 dB μ	S-9+40dB
F-10 S50	86 dB μ	S-9+50dB
F-11 S60	96 dB μ	S-9+60dB

- ❑ Press and hold in the [MENU] button for one second to save the new settings and exit the alignment mode.

FM Gain Adjustment

- ❑ Set the Main Band (VFO-A) frequency to 28.850 MHz in the FM-W mode.
- ❑ Set the following controls as indicated:
 [ANT 1-2] button: ANT 1
 [IPO] button: AMP1
 [ATT] button: OFF
 [μ -TUNE] button: THRU
 [R.FLT] button: 15 kHz
 [AGC] button: AUTO
 [RF GAIN] knob: Fully clockwise
- ❑ Set the RF Signal Generator to 12 dB μ at the 28.8500 MHz with ± 3.5 kHz deviation FM modulation of a 1 kHz audio signal.
- ❑ Press and hold in the [1.8(1)], [3.5(2)], and [7(3)] keys, while turning the radio on, to enter the alignment mode.
- ❑ Rotate the Main Tuning Dial knob to select the alignment parameter “G-02 FnG”.
- ❑ Rotate the [CLAR(VFO-B)] knob so that the S-meter reading is “S-3”.
- ❑ Press and hold in the [MENU] button for 2 seconds to save the new setting and exit the alignment mode.
- ❑ Set the RF Signal Generator to 12 dB μ at the 52.000 MHz with ± 3.5 kHz deviation FM modulation of a 1 kHz audio signal.
- ❑ Set the VFO-A frequency to 52.000 MHz in the FM-W mode.
- ❑ Press and hold in the [1.8(1)], [3.5(2)], and [7(3)] keys, while turning the radio on, to enter the alignment mode again.
- ❑ Rotate the Main Tuning Dial knob to select the alignment parameter “G-03 FnG”.
- ❑ Rotate the [CLAR(VFO-B)] knob so that the S-meter reading is “S-3”.
- ❑ Press and hold in the [MENU] button for one second to save the new setting and exit the alignment mode.

Transmitter Adjustment

TX IFT Adjustment

- ❑ Disconnect the coaxial cable from J1011 on the MAIN Unit, then connect the RF millivoltmeter to J1011.
- ❑ Set the VFO-A frequency to 14.200 MHz in the FM mode.
- ❑ Set the value of Menu item "111 TGEN TX PWR" to "100".
- ❑ Press the PTT button, adjust T1021, T1014, T1010, and T1009 for maximum deflection on the RF millivoltmeter.
- ❑ Release the PTT button.
- ❑ Disconnect the RF millivoltmeter from J1011, then re-connect the coaxial cable to J1011.

TX Scope Circuit Adjustment

- ❑ Disconnect the coaxial cable from J1028 on the MAIN Unit, then connect the RF millivoltmeter to J1028.
- ❑ Set the VFO-A frequency to 14.200 MHz in the CW mode.
- ❑ Set the value of Menu item "111 TGEN TX PWR" to "100".
- ❑ Press the PTT button, then adjust T1006 for maximum deflection on the RF millivoltmeter.
- ❑ Release the PTT button.
- ❑ Disconnect the RF millivoltmeter from J1028, then re-connect the coaxial cable to J1028.

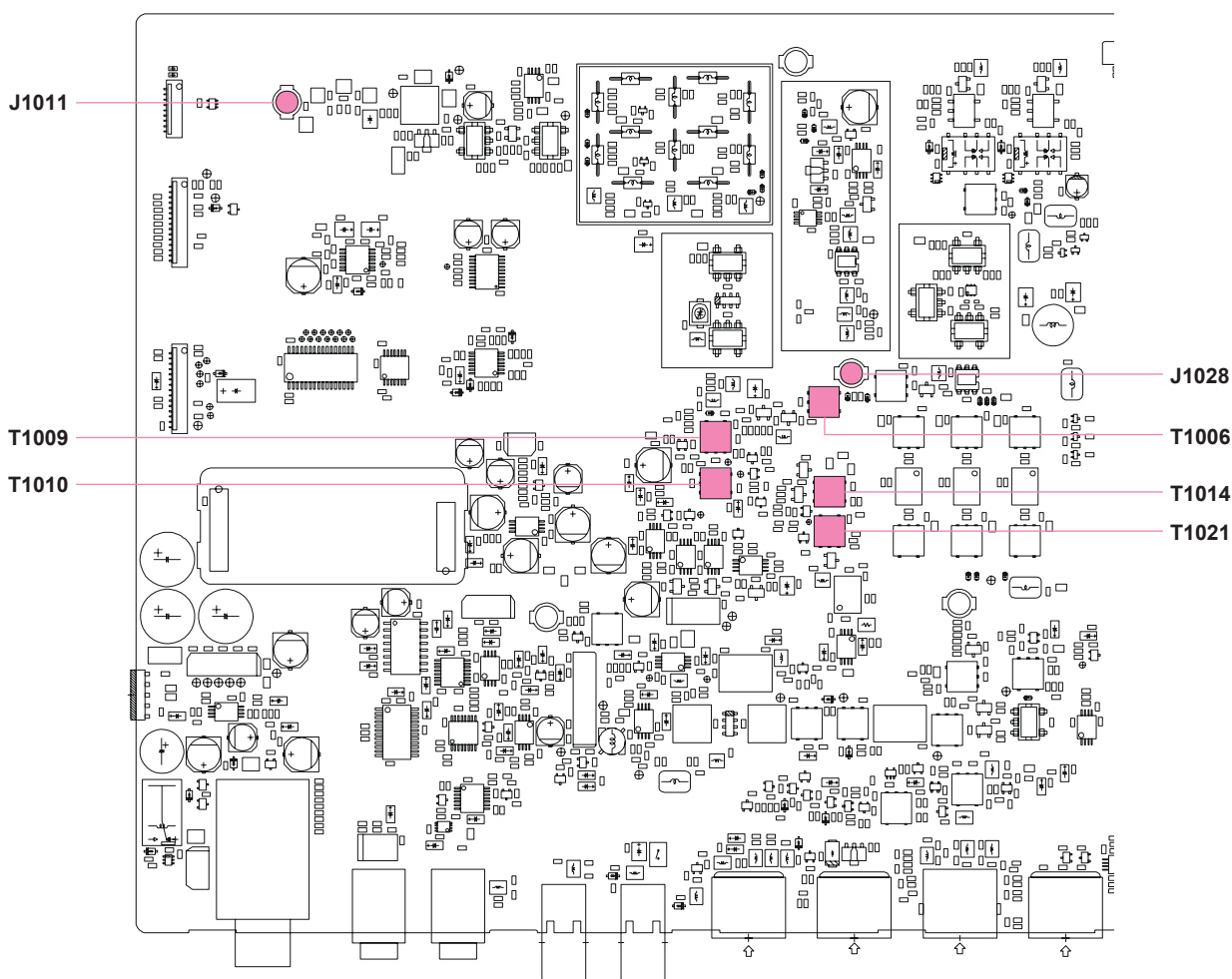

MAIN UNIT (TRANSMITTER SECTION) ALIGNMENT POINTS

Alignment

PA-A Unit Adjustment

Preparation

- ❑ Connect the 50-Ohm Dummy Load and Wattmeter to the “ANT 1” jack.
- ❑ Disconnect the coaxial cables from J5001 and J5006 on the PA-A Unit, then terminate J5001 and J5006, each with a 50-Ohm resistor.
- ❑ Disconnect the jumper plugs from J5003 and J5004 on the PA-A Unit, and remove the jumper wire that is connected between TP5031 and TP5032 on the PA-A Unit.

Pre-Drive Stage Idling Current Adjustment

- ❑ Connect the DC ammeter to J5003 on the PA-A Unit.
- ❑ Press and hold in the [1.8(1)], [3.5(2)], and [7(3)] keys, while turning the radio on, to enter the alignment mode.
- ❑ Rotate the Main Tuning Dial knob to select the alignment parameter “H-01 Pdb”.
- ❑ Press the PTT button, then adjust the [CLAR(VFO-B)] knob so that the DC ammeter reading is “100 mA (± 5 mA)”.
- ❑ Release the PTT button.

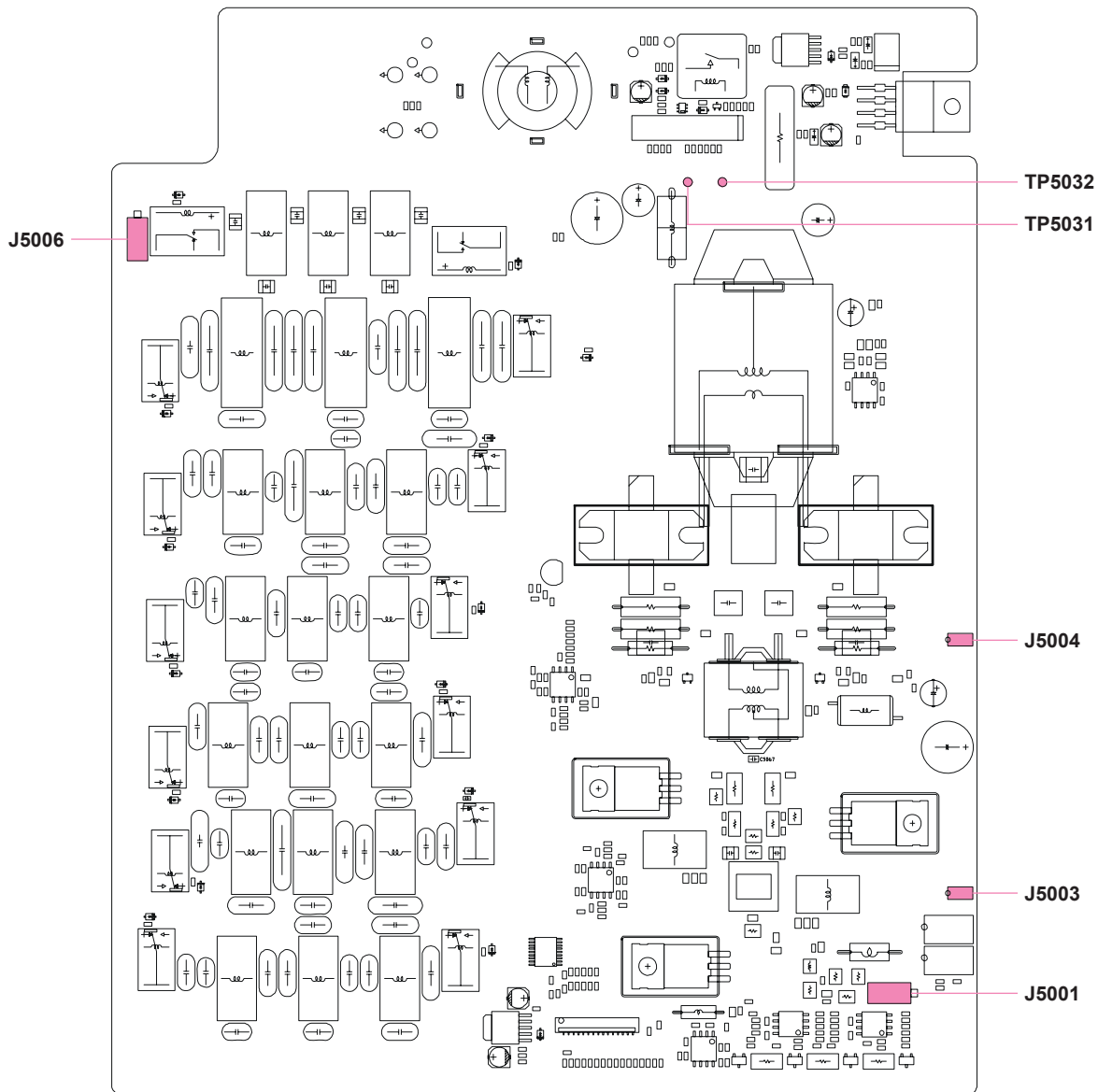

PA-A UNIT ALIGNMENT POINTS

Drive Stage Idling Current Adjustment

- ❑ Connect the DC ammeter to J5004 on the PA-A Unit.
- ❑ Rotate the Main Tuning Dial knob to select the alignment parameter “H-02 db1”.
- ❑ Press the PTT button, then adjust the [CLAR(VFO-B)] knob so that the DC ammeter reading is “500 mA (± 50 mA)”.
- ❑ Release the PTT button.
- ❑ Rotate the Main Tuning Dial knob to select the alignment parameter “H-03 db2”.
- ❑ Press the PTT button, then adjust the [CLAR(VFO-B)] knob so that the DC ammeter reading is “500 mA (± 50 mA)”.
- ❑ Release the PTT button.

Final Stage Idling Current Adjustment

- ❑ Connect the DC ammeter between TP5031 and TP5032 on the PA-A Unit.
- ❑ Rotate the Main Tuning Dial knob to select the alignment parameter “H-04 Fb1”.
- ❑ Press the PTT button, then adjust the [CLAR(VFO-B)] knob so that the DC ammeter reading is “1 A (± 50 mA)”.
- ❑ Release the PTT button.
- ❑ Rotate the Main Tuning Dial knob to select the alignment parameter “H-05 Fb2”.
- ❑ Press the PTT button, then adjust the [CLAR(VFO-B)] knob so that the DC ammeter reading is “1 A (± 50 mA)”.
- ❑ Release the PTT button.

Termination

- ❑ Press and hold in the [MENU] button for one second to save the new settings and exit the alignment mode.
- ❑ Disconnect the 50-Ohm resistors from J5001 and J5006, then connect the coaxial cables to J5001 and J5006.
- ❑ Re-connect the jumper plugs to J5003 and J5004, and re-connect the jumper wire between TP5031 and TP5032.

Antenna Tuner Adjustment

CM Coupler Balance Adjustment

- ❑ Connect the 50-Ohm Dummy Load and Wattmeter to the “ANT 1” jack.
- ❑ Connect the Digital DC voltmeter (high-Z) to pin 3 of J6003 on the TUNER Unit.
- ❑ Turn off the [TUNE] switch, then set the VFO-A frequency to 24.900 MHz in the CW mode.
- ❑ Press and hold in the [1.8(1)], [3.5(2)], and [7(3)] keys, while turning the radio on, to enter the alignment mode.
- ❑ Rotate the Main Tuning Dial knob to select the alignment parameter “I-08 iAL”.
- ❑ Press the PTT button, then rotate the [CLAR(VFO-B)] knob for 50 Watts on the Wattmeter.
- ❑ Adjust TC6001 on the TUNER Unit for minimum deflection on the DC voltmeter (less than 0.1 V).
- ❑ Release the PTT button, then press the [MENU] button momentarily to exit the alignment mode.

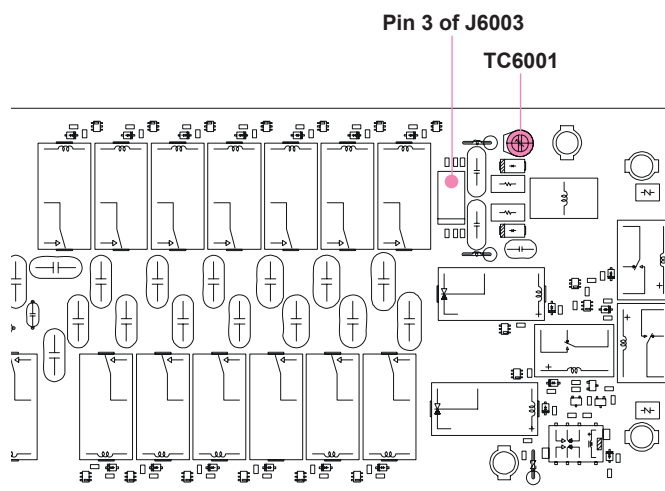

TUNER UNIT ALIGNMENT POINTS

Alignment

Current ALC Adjustment

- ❑ Connect the 50-Ohm Dummy Load and Wattmeter to the “ANT 1” jack.
- ❑ Set the VFO-A frequency to 3.750 MHz in the CW mode.
- ❑ Press and hold in the [1.8(1)], [3.5(2)], and [7(3)] keys, while turning the radio on, to enter the alignment mode.
- ❑ Rotate the Main Tuning Dial knob to select the alignment parameter “I-02 iAL”.
- ❑ Press the PTT button, then adjust the [CLAR(VFO-B)] knob for 125 W (+5W/–0W) on the Wattmeter.
- ❑ Release the PTT button, then press the [ENT] key.
- ❑ Press and hold in the [MENU] button for one second to save the new setting and exit the alignment mode.

ALC Meter Adjustment

- ❑ Connect the 50-Ohm Dummy Load and Wattmeter to the “ANT 1” jack.
- ❑ Set the VFO-A frequency to 14.200 MHz in the CW mode.
- ❑ Press and hold in the [1.8(1)], [3.5(2)], and [7(3)] keys, while turning the radio on, to enter the alignment mode.
- ❑ Rotate the Main Tuning Dial knob to select the alignment parameter “N-01 P1h”.
- ❑ Rotate the [CLAR(VFO-B)] knob so that the Multi-Display Window shows “0”.
- ❑ Press the PTT button, then rotate the [CLAR(VFO-B)] knob for 100 W (+5W/–0W) on the Wattmeter.
- ❑ Release the PTT button.
- ❑ Press and hold in the [MENU] button for one second to save the new setting and exit the alignment mode.
- ❑ Set the VFO-A frequency to 14.200 MHz in the USB mode.
- ❑ Set the value of Menu item “111 TGEN TX PWR” to “100”.
- ❑ Connect the Audio Generator to pin 8 of the MIC jack (pin 7: GND), then set the output level to 0.5 mV @1 kHz.
- ❑ Set the MIC GAIN knob to 12 o'clock position.
- ❑ Press the PTT button, then adjust the Audio Generator output level to the position where the ALC meter just starts to deflect.
- ❑ Release the PTT button.
- ❑ Increase the Audio Generator output level by “9 dB”.
- ❑ Press the [ENT] key *while pressing and holding in the PTT button*.
- ❑ Release the PTT button, then press and hold in the [MENU] button for one second to save the new setting and exit the alignment mode.

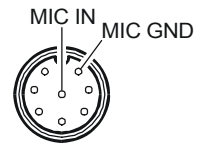

TX Output Power/PO Meter/TXG Adjustment

- Referring to table below, tune the transceiver to each frequency listed.

BAND	VFO-A FREQUENCY	MODE
1.8 MHz Band	1.820 MHz	CW
3.5 MHz Band	3.570 MHz	CW
7 MHz Band	7.050 MHz	CW
10 MHz Band	10.100 MHz	CW
14 MHz Band	14.200 MHz	CW
18 MHz Band	18.100 MHz	CW
21 MHz Band	21.200 MHz	CW
24.5 MHz Band	24.900 MHz	CW
28 MHz Band	28.700 MHz	CW
50 MHz Band	52.000 MHz*	CW

* UK: 51.000 MHz, EU: 50.250 MHz, FRA: 50.700 MHz

- Connect the 50-Ohm Dummy Load and Wattmeter to the “ANT 1” jack.
- Set the VFO-A frequency to 1.820 MHz in the CW mode.
- Press and hold in the [1.8(1)], [3.5(2)], and [7(3)] keys, while turning the radio on, to enter the alignment mode.

- Rotate the Main Dial knob to select the alignment parameter “J-01 P1h”.
- Press the PTT button, then rotate the [CLAR(VFO-B)] knob for 101 W (+5W/–1W) on the Wattmeter.
- Release the button.
- Rotate the Main Dial knob to select the alignment parameter “J-02 P1h”.
- Press the PTT button to save the new setting.
- Release the button.
- Rotate the Main Dial knob to select the alignment parameter “J-03 P1h”.
- Press the PTT button, then rotate the [CLAR(VFO-B)] knob for maximum deflection on the ALC meter zone.
- Release the button.

ALIGNMENT MENU	OPERATION	POWER METER (ADJUST TO)	ALC METER (ADJUST TO)	ALIGNMENT MENU	OPERATION	POWER METER (ADJUST TO)	ALC METER (ADJUST TO)		
1.9 MHz	J-01 P1h	Rotate the [CLAR(VFO-B)] knob	101 W (+5 W / –1 W)	14 MHz	N-01 P1h	Rotate the [CLAR(VFO-B)] knob	101 W (+5 W / –1 W)		
	J-02 P1h	Press the [PTT] button	–		N-02 P1h	Press the [PTT] button	–	–	
	J-03 P1h	Rotate the [CLAR(VFO-B)] knob	–		Turns on 16 dots	N-03 P1h	Rotate the [CLAR(VFO-B)] knob	–	Turns on 16 dots
	J-04 P50	Rotate the [CLAR(VFO-B)] knob	50 W (+5 W / –0 W)		–	N-04 P50	Rotate the [CLAR(VFO-B)] knob	50 W (+5 W / –0 W)	–
	J-05 P50	Press the [PTT] button	–		–	N-05 P50	Press the [PTT] button	–	–
	J-06 P50	Rotate the [CLAR(VFO-B)] knob	–		Turns on 16 dots	N-06 P50	Rotate the [CLAR(VFO-B)] knob	–	Turns on 16 dots
	J-07 P20	Rotate the [CLAR(VFO-B)] knob	20 W (+2 W / –0 W)		–	N-07 P20	Rotate the [CLAR(VFO-B)] knob	20 W (+2 W / –0 W)	–
	J-08 P20	Press the [PTT] button	–		–	N-08 P20	Press the [PTT] button	–	–
	J-09 P20	Rotate the [CLAR(VFO-B)] knob	–		Turns on 16 dots	N-09 P20	Rotate the [CLAR(VFO-B)] knob	–	Turns on 16 dots
	J-10 P10	Rotate the [CLAR(VFO-B)] knob	10 W (+1 W / –0 W)		–	N-10 P10	Rotate the [CLAR(VFO-B)] knob	10 W (+1 W / –0 W)	–
	J-11 P10	Press the [PTT] button	–		–	N-11 P10	Press the [PTT] button	–	–
	J-12 P10	Rotate the [CLAR(VFO-B)] knob	–		Turns on 16 dots	N-12 P10	Rotate the [CLAR(VFO-B)] knob	–	Turns on 16 dots
	J-13 P05	Rotate the [CLAR(VFO-B)] knob	5 W (+1 W / –0 W)		–	N-13 P05	Rotate the [CLAR(VFO-B)] knob	5 W (+1 W / –0 W)	–
	J-14 P05	Press the [PTT] button	–		–	N-14 P05	Press the [PTT] button	–	–
	J-15 P05	Rotate the [CLAR(VFO-B)] knob	–		Turns on 13 dots	N-15 P05	Rotate the [CLAR(VFO-B)] knob	–	Turns on 13 dots
3.5 MHz	K-01 P1h	Rotate the [CLAR(VFO-B)] knob	101 W (+5 W / –1 W)	24 MHz	Q-01 P1h	Rotate the [CLAR(VFO-B)] knob	101 W (+5 W / –1 W)		
	K-02 P1h	Press the [PTT] button	–		–	Q-02 P1h	Press the [PTT] button	–	–
	K-03 P1h	Rotate the [CLAR(VFO-B)] knob	–		Turns on 16 dots	Q-03 P1h	Rotate the [CLAR(VFO-B)] knob	–	Turns on 16 dots
	K-04 P50	Rotate the [CLAR(VFO-B)] knob	50 W (+5 W / –0 W)		–	Q-04 P50	Rotate the [CLAR(VFO-B)] knob	50 W (+5 W / –0 W)	–
	K-05 P50	Press the [PTT] button	–		–	Q-05 P50	Press the [PTT] button	–	–
	K-06 P50	Rotate the [CLAR(VFO-B)] knob	–		Turns on 16 dots	Q-06 P50	Rotate the [CLAR(VFO-B)] knob	–	Turns on 16 dots
	K-07 P20	Rotate the [CLAR(VFO-B)] knob	20 W (+2 W / –0 W)		–	Q-07 P20	Rotate the [CLAR(VFO-B)] knob	20 W (+2 W / –0 W)	–
	K-08 P20	Press the [PTT] button	–		–	Q-08 P20	Press the [PTT] button	–	–
	K-09 P20	Rotate the [CLAR(VFO-B)] knob	–		Turns on 16 dots	Q-09 P20	Rotate the [CLAR(VFO-B)] knob	–	Turns on 16 dots
	K-10 P10	Rotate the [CLAR(VFO-B)] knob	10 W (+1 W / –0 W)		–	Q-10 P10	Rotate the [CLAR(VFO-B)] knob	10 W (+1 W / –0 W)	–
	K-11 P10	Press the [PTT] button	–		–	Q-11 P10	Press the [PTT] button	–	–
	K-12 P10	Rotate the [CLAR(VFO-B)] knob	–		Turns on 16 dots	Q-12 P10	Rotate the [CLAR(VFO-B)] knob	–	Turns on 16 dots
	K-13 P05	Rotate the [CLAR(VFO-B)] knob	5 W (+1 W / –0 W)		–	Q-13 P05	Rotate the [CLAR(VFO-B)] knob	5 W (+1 W / –0 W)	–
	K-14 P05	[PTT] button	–		–	Q-14 P05	[PTT] button	–	–
	K-15 P05	Rotate the [CLAR(VFO-B)] knob	–		Turns on 13 dots	Q-15 P05	Rotate the [CLAR(VFO-B)] knob	–	Turns on 13 dots
7 MHz	L-01 P1h	Rotate the [CLAR(VFO-B)] knob	101 W (+5 W / –1 W)	50 MHz	S-01 P1h	Rotate the [CLAR(VFO-B)] knob	101 W (+5 W / –1 W)		
	L-02 P1h	Press the [PTT] button	–		–	S-02 P1h	Press the [PTT] button	–	–
	L-03 P1h	Rotate the [CLAR(VFO-B)] knob	–		Turns on 16 dots	S-03 P1h	Rotate the [CLAR(VFO-B)] knob	–	Turns on 16 dots
	L-04 P50	Rotate the [CLAR(VFO-B)] knob	50 W (+5 W / –0 W)		–	S-04 P50	Rotate the [CLAR(VFO-B)] knob	50 W (+5 W / –0 W)	–
	L-05 P50	Press the [PTT] button	–		–	S-05 P50	Press the [PTT] button	–	–
	L-06 P50	Rotate the [CLAR(VFO-B)] knob	–		Turns on 16 dots	S-06 P50	Rotate the [CLAR(VFO-B)] knob	–	Turns on 16 dots
	L-07 P20	Rotate the [CLAR(VFO-B)] knob	20 W (+2 W / –0 W)		–	S-07 P20	Rotate the [CLAR(VFO-B)] knob	20 W (+2 W / –0 W)	–
	L-08 P20	Press the [PTT] button	–		–	S-08 P20	Press the [PTT] button	–	–
	L-09 P20	Rotate the [CLAR(VFO-B)] knob	–		Turns on 16 dots	S-09 P20	Rotate the [CLAR(VFO-B)] knob	–	Turns on 16 dots
	L-10 P10	Rotate the [CLAR(VFO-B)] knob	10 W (+1 W / –0 W)		–	S-10 P10	Rotate the [CLAR(VFO-B)] knob	10 W (+1 W / –0 W)	–
	L-11 P10	Press the [PTT] button	–		–	S-11 P10	Press the [PTT] button	–	–
	L-12 P10	Rotate the [CLAR(VFO-B)] knob	–		Turns on 16 dots	S-12 P10	Rotate the [CLAR(VFO-B)] knob	–	Turns on 16 dots
	L-13 P05	Rotate the [CLAR(VFO-B)] knob	5 W (+1 W / –0 W)		–	S-13 P05	Rotate the [CLAR(VFO-B)] knob	5 W (+1 W / –0 W)	–
	L-14 P05	Press the [PTT] button	–		–	S-14 P05	Press the [PTT] button	–	–
	L-15 P05	Rotate the [CLAR(VFO-B)] knob	–		Turns on 13 dots	S-15 P05	Rotate the [CLAR(VFO-B)] knob	–	Turns on 13 dots

Note: The 10 MHz, 18 MHz, 21 MHz, and 28 MHz bands do not need the adjustment.

Alignment

- ❑ Perform the same procedures for the Alignment Menus “J-04 P50” through “J-15 P05”, “K-01 P1h” through “K-15 P05”, “L-01 P1h” through “L-15 P05” per the chart at the right.
- ❑ Press the [ENT] key to save the new setting at 1.8 MHz, 3.5 MHz, 7 MHz, and 10 MHz Bands.
- ❑ Perform the same procedures for the Alignment Menus “N-01 P1h” through “N-15 P05” per the chart at the right.
- ❑ Press the [ENT] key to save the new setting at 14 MHz, 18 MHz, and 21 MHz Bands.
- ❑ Perform the same procedures for the Alignment Menus “Q-01 P1h” through “Q-15 P05” per the chart at the right.
- ❑ Press the [ENT] key to save the new setting at 24 MHz and 28 MHz Bands.
- ❑ Perform the same procedures for the Alignment Menus “S-01 P1h” through “S-15 P05” per the chart below.
- ❑ Press and hold in the [MENU] button for one second to save the new settings and exit the alignment mode.

AM-TXG Adjustment

- ❑ Connect the 50-Ohm Dummy Load and Wattmeter to the “ANT 1” jack.
- ❑ Set the value of Menu item “111 TGEN TX PWR” to “100”, and Menu item “112 TGEN AM CAR” to “100”.
- ❑ Set the VFO-A frequency to 14.200 MHz in the AM mode.
- ❑ Press and hold in the [1.8(1)], [3.5(2)], and [7(3)] keys, while turning the radio on, to enter the alignment mode.
- ❑ Rotate the Main Tuning Dial knob to select the alignment parameter “T-02 tCA.”
- ❑ Rotate the [CLAR(VFO-B)] knob so that the Multi-Display Window shows “0”.
- ❑ Press the PTT button without microphone input, then rotate the [CLAR(VFO-B)] knob for 70 W (± 5 W) on the Wattmeter.
- ❑ Release the PTT button.
- ❑ Press and hold in the [MENU] button for one second to save the new setting and exit the alignment mode.

REV-ALC Adjustment

- ❑ Disconnect the test equipment from the “ANT 1” jack.
- ❑ Press and hold in the [1.8(1)], [3.5(2)], and [7(3)] keys, while turning the radio on, to enter the alignment mode.
- ❑ Rotate the Main Tuning Dial knob to select the alignment parameter “U-01 rAC.”
- ❑ Press the PTT button, then rotate the [CLAR(VFO-B)] knob so that the PO meter turns on 14 dots.
- ❑ Release the PTT button, then press the [ENT] key.
- ❑ Press and hold in the [MENU] button for one second to save the new setting and exit the alignment mode.

ID Meter Adjustment

Choose one of the adjustment methods described below, according to the equipment you have available. *If you perform adjustment method (2) Using a DC Ammeter, complete the transmit adjustments on ALIGNMENT page 9 through 14.*

1) Using an Electronic Load

- ❑ Remove the jumper wire that is connected between TP5031 and TP5032 on the PA-A Unit, then connect the Electronic Load to TP5032 and GND.
- ❑ Set the VFO-A frequency to 14.200 MHz in the CW mode.
- ❑ Press and hold in the [1.8(1)], [3.5(2)], and [7(3)] keys, while turning the radio on, to enter the alignment mode.
- ❑ Rotate the Main Tuning Dial knob to select the alignment parameter “X-01 Idd”.
- ❑ Press the PTT button, then adjust the Electronic Load to “10 A”.
- ❑ Press the [ENT] key, then release the PTT button.
- ❑ Press and hold in the [MENU] button for one second to save the new setting and exit the alignment mode.

2) Using a DC Ammeter

- ❑ Connect the 50-Ohm Dummy Load and Wattmeter to the “ANT 1” jack.
- ❑ Remove the jumper wire that is connected between TP5031 and TP5032 on the PA-A Unit, then connect the DC ammeter (15-A range) between TP5031 and TP5032.
- ❑ Set the VFO-A frequency to 14.200 MHz in the CW mode.
- ❑ Press the PTT button, set the DC ammeter for 10 A via Menu item “111 TGEN TX PWR”.
- ❑ Release the PTT button, then press and hold in the [MENU] button for one second to save the new setting and exit the menu mode.
- ❑ Press and hold in the [1.8(1)], [3.5(2)], and [7(3)] keys, while turning the radio on, to enter the alignment mode.
- ❑ Rotate the Main Tuning Dial knob to select the alignment parameter “X-01 Idd”.
- ❑ Press the PTT button, confirm the DC ammeter readig is 10 A.
- ❑ Press the [ENT] key, then release the PTT button.
- ❑ Press and hold in the [MENU] button for one second to save the new setting and exit the alignment mode.

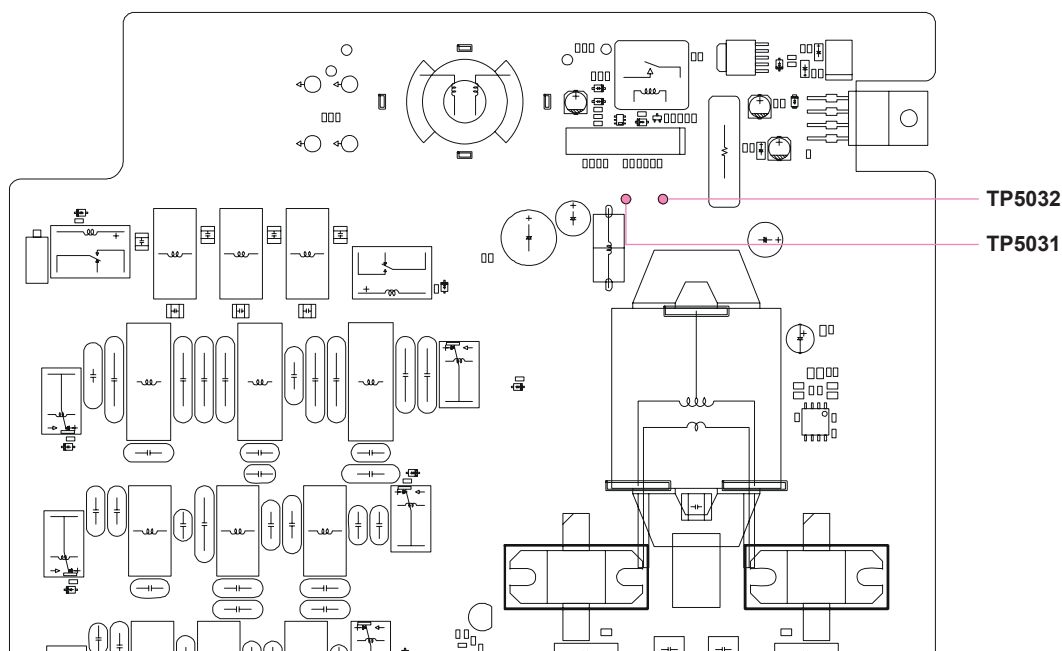

PA-A UNIT ALIGNMENT POINTS

Alignment

FM MAX Deviation Adjustment

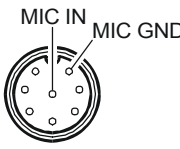
- ❑ Connect the Dummy Load, Wattmeter, and Deviation Meter to the “ANT 1” Jack.
 - ❑ Set the VFO-A frequency to 28.700 MHz in the FM mode.
 - ❑ Set the value of Menu item “056 F3E MIC ” to “50”.
 - ❑ Connect the Audio Generator to pin 8 of the MIC jack (pin 7: GND), then set the output level to 2 mV @1 kHz.
- 
- ❑ Press and hold in the [1.8(1)], [3.5(2)], and [7(3)] keys, while turning the radio on, to enter the alignment mode.
 - ❑ Rotate the Main Tuning Dial knob to select the alignment parameter “V-02 F45”.
 - ❑ Press the PTT button, then rotate the [CLAR(VFO-B)] knob for 4.5 kHz (± 0.2 kHz) on the Deviation Meter.
 - ❑ Release the PTT button.
 - ❑ Press the [NAR] button to set the VFO-A operating mode to the FM-N mode.
 - ❑ Rotate the Main Tuning Dial knob to select the alignment parameter “V-03 F23”.
 - ❑ Press the PTT button, then rotate the [CLAR(VFO-B)] knob for 2.25 kHz (± 0.15 kHz) on the Deviation Meter.
 - ❑ Release the PTT button.
 - ❑ Press and hold in the [MENU] button for one second to save the new setting and exit the alignment mode.

SWR Meter Adjustment

- ❑ Set the VFO-A frequency to 28.700 MHz in the CW mode.
- ❑ Connect the 50-Ohm Dummy Load and Wattmeter to the “ANT 1” Jack.
- ❑ Connect the 1/4-inch 3-contact Plug to the KEY jack (but, without the key).
- ❑ Set the Multi Function Meter to “SWR” by pressing the [METER] button.

- ❑ Disconnect the 3-pin plug from J1014 on the MAIN Unit, then apply a 2.75 V DC voltage to pin 2 of J1014, and 1.00 V DC to pin 3 of J1014.
- ❑ Press and hold in the [1.8(1)], [3.5(2)], and [7(3)] keys, while turning the radio on, to enter the alignment mode.
- ❑ Rotate the Main Tuning Dial knob to select the alignment parameter “W-03 S30.”
- ❑ Press the [MOX] button, then rotate the [CLAR(VFO-B)] knob so that the SWR meter (on the front panel) reading is “3.0”. The SWR meter reading (3.0) is broad (few points). Therefore, set the [CLAR(VFO-B)] knob to the center of this broad range.
- ❑ Release the [MOX] button.
- ❑ Apply a 2.96 V DC voltage to pin 2 of J1014, and 1.00 V DC to pin 3 of J1014.
- ❑ Rotate the Main Tuning Dial knob to select the alignment parameter “W-06 S30.”
- ❑ Press the [MOX] button, then rotate the [CLAR(VFO-B)] knob so that the SWR meter (on the front panel) reading is “3.0.” The SWR meter reading (3.0) is broad (few points). Therefore, set the [CLAR(VFO-B)] knob to the center of this broad range.
- ❑ Release the [MOX] button.
- ❑ Apply a 3.81 V DC voltage to pin 2 of J1014, and 1.00 V DC to pin 3 of J1014.
- ❑ Rotate the Main Tuning Dial knob to select the alignment parameter “W-09 S30.”
- ❑ Press the [MOX] button, then rotate the [CLAR(VFO-B)] knob so that the SWR meter (on the front panel) reading is “3.0.” The SWR meter reading (3.0) is broad (few points). Therefore, set the [CLAR(VFO-B)] knob to the center of this broad range.
- ❑ Release the [MOX] button.
- ❑ Press and hold in the [MENU] button for 2 seconds to save the new settings and exit the alignment mode.
- ❑ Re-connect the 3-pin plug to J1014 on the MAIN Unit.

MAIN Unit Circuit Diagram

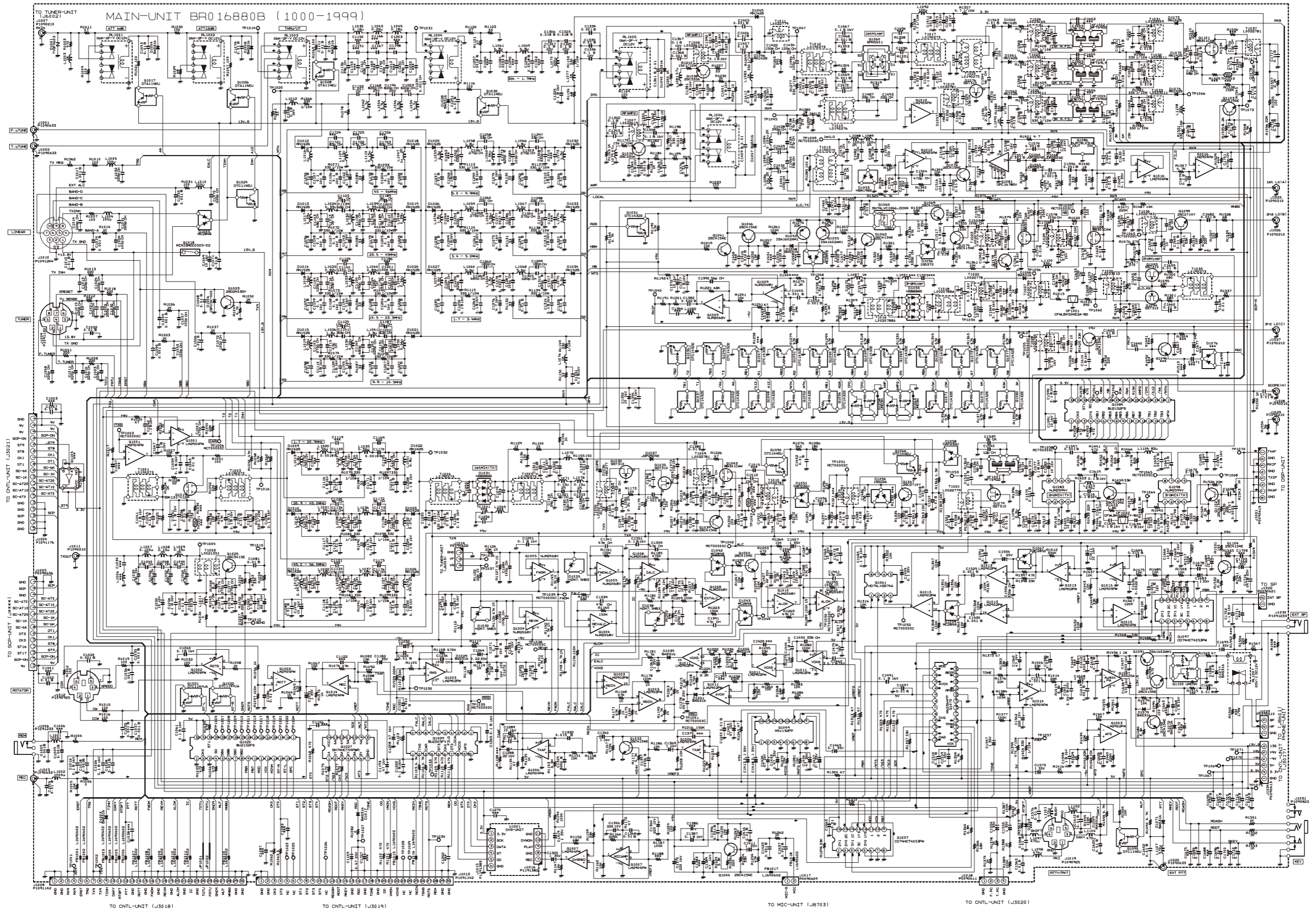

MAIN Unit

Note

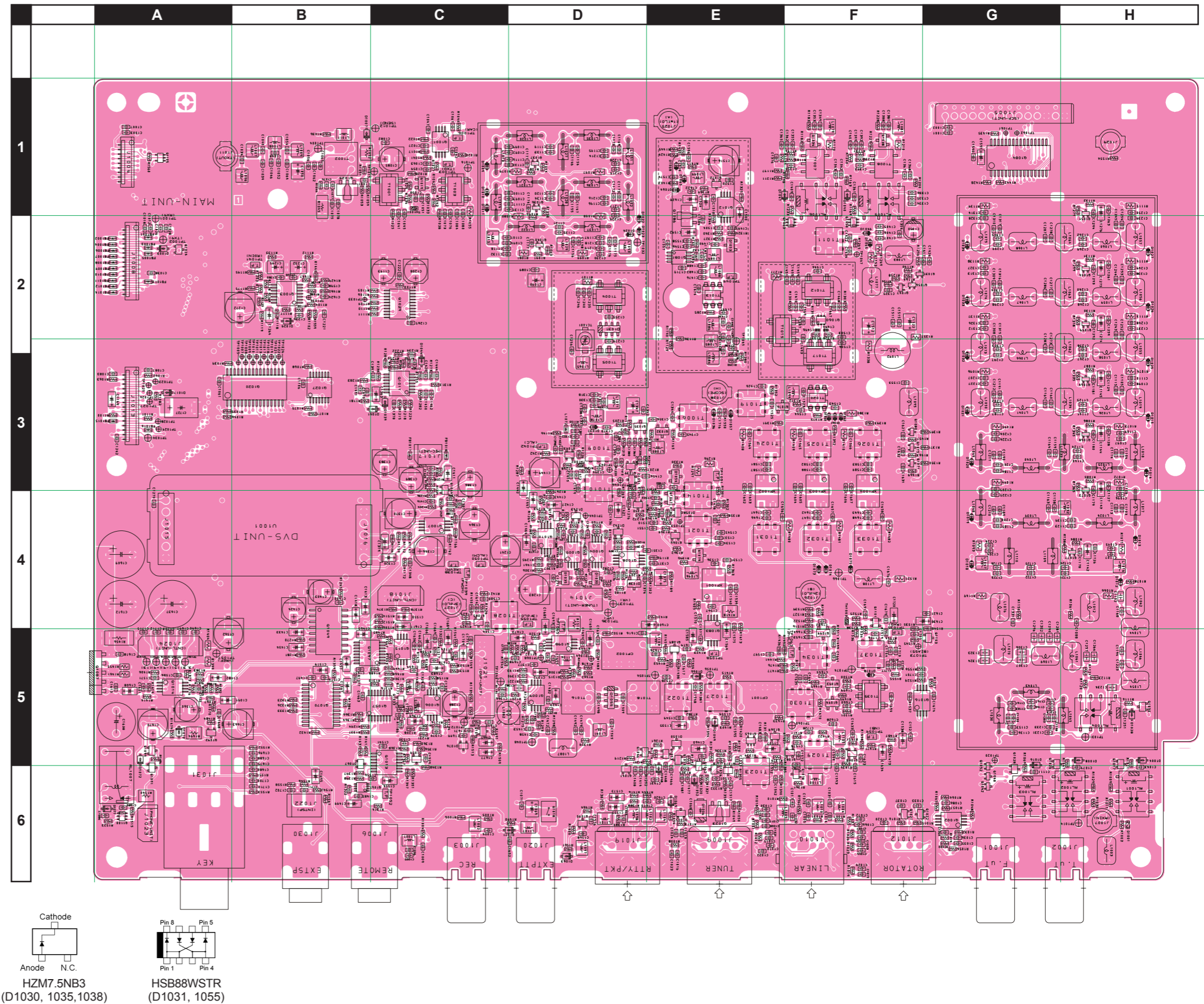
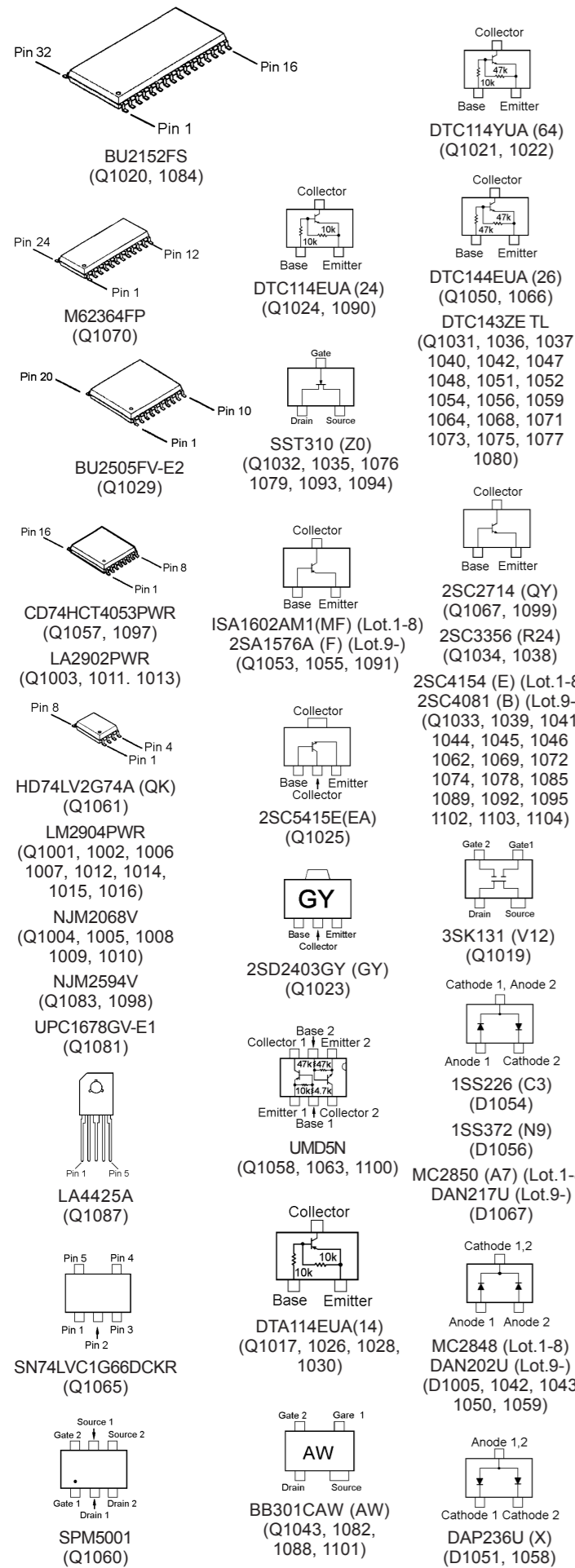

MAIN Unit

Parts Layout (Side A)

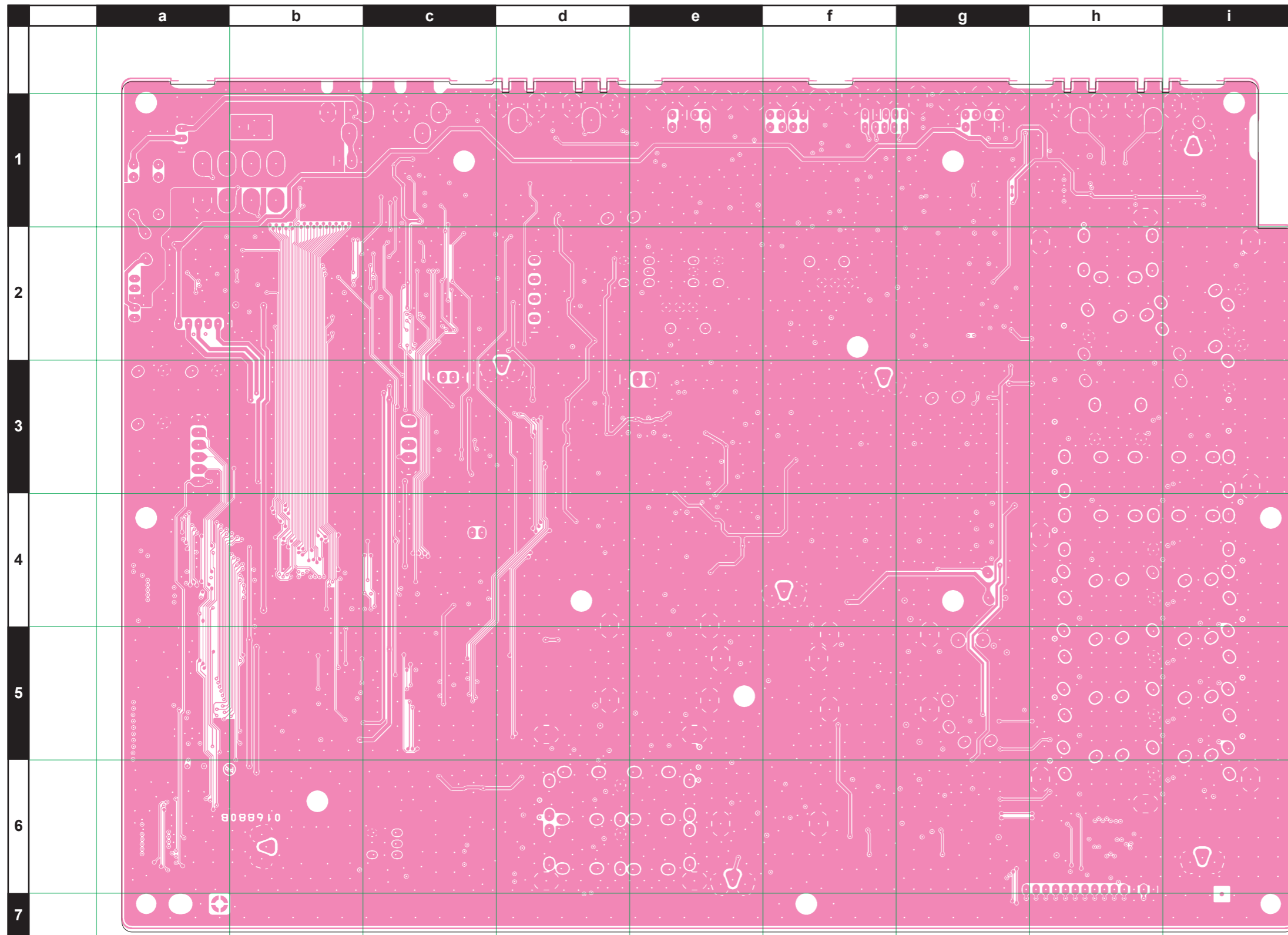

MAIN Unit

Parts List

REF	DESCRIPTION	VALUE	V/W	TOL.	MFR'S DESIG	VXSTD P/N	VERS.	LOT	SIDE	LAY ADR
PCB with Components						CS1966001				
Printed Circuit Board						FR016880B		1-		
C 1055	CHIP CAP.	0.001uF	50V	B	GRM188B11H102KA01D	K22174821		1-	A	F6
C 1056	CHIP CAP.	0.1uF	16V	B	GRM188B11C104KA01D	K22124805		1-	A	B1
C 1057	CHIP CAP.	100pF	50V	CH	GRM1882C1H101JA01D	K22174235		1-	A	F6
C 1058	CHIP CAP.	0.01uF	50V	B	GRM188B11H103KA01D	K22174823		1-	A	C1
C 1059	CHIP CAP.	0.1uF	16V	B	GRM188B11C104KA01D	K22124805		1-	A	C1
C 1060	CHIP CAP.	0.1uF	16V	B	GRM188B11C104KA01D	K22124805		1-	A	G6
C 1061	CHIP CAP.	0.1uF	16V	B	GRM188B11C104KA01D	K22124805		1-	A	A3
C 1062	CHIP CAP.	0.01uF	50V	B	GRM188B11H103KA01D	K22174823		1-	A	B1
C 1063	CHIP CAP.	0.01uF	50V	B	GRM188B11H103KA01D	K22174823		1-	A	C1
C 1064	CHIP CAP.	47pF	50V	CH	GRM1882C1H470JA01D	K22174227		1-	A	B1
C 1065	CHIP CAP.	0.001uF	50V	B	GRM188B11H102KA01D	K22174821		1-	A	B1
C 1066	CHIP CAP.	0.001uF	50V	B	GRM188B11H102KA01D	K22174821		1-	A	F6
C 1067	CHIP CAP.	470pF	50V	CH	GRM1882C1H471JA01D	K22174249		1-	A	C1
C 1068	CHIP CAP.	0.01uF	50V	B	GRM188B11H103KA01D	K22174823		1-	A	E6
C 1069	CHIP TA.CAP.	10uF	16V		TEESVB21C106M8R	K78120025		1-	A	D6
C 1070	CHIP CAP.	220pF	50V	CH	GRM1882C1H221JA01D	K22174243		1-	A	F6
C 1071	CHIP CAP.	0.01uF	50V	B	GRM188B11H103KA01D	K22174823		1-	A	D6
C 1072	CHIP CAP.	100pF	50V	CH	GRM1882C1H101JA01D	K22174235		1-	A	F6
C 1073	CHIP CAP.	0.1uF	16V	B	GRM188B11C104KA01D	K22124805		1-	A	C1
C 1074	CHIP CAP.	270pF	50V	CH	GRM1882C1H271JA01D	K22174251		1-	A	B1
C 1075	CHIP CAP.	0.01uF	50V	B	GRM188B11H103KA01D	K22174823		1-	A	B1
C 1076	CHIP CAP.	0.01uF	50V	B	GRM188B11H103KA01D	K22174823		1-	A	C1
C 1077	CHIP CAP.	270pF	50V	CH	GRM1882C1H271JA01D	K22174251		1-	A	B1
C 1078	CHIP CAP.	0.1uF	16V	B	GRM188B11C104KA01D	K22124805		1-	A	B1
C 1079	CHIP CAP.	0.01uF	50V	B	GRM188B11H103KA01D	K22174823		1-	A	H5
C 1080	CHIP CAP.	0.01uF	50V	B	GRM188B11H103KA01D	K22174823		1-	A	C1
C 1081	CHIP CAP.	0.01uF	50V	B	GRM188B11H103KA01D	K22174823		1-	A	B1
C 1082	CHIP CAP.	0.1uF	16V	B	GRM188B11C104KA01D	K22124805		1-	A	C1
C 1084	CHIP CAP.	0.1uF	16V	B	GRM188B11C104KA01D	K22124805		1-	A	C1
C 1085	AL.ELECTRO.CAP.	22uF	16V		EEE1CA220SR	K48120024		1-	A	C1
C 1086	CHIP CAP.	0.01uF	50V	B	GRM188B11H103KA01D	K22174823		1-	A	G6
C 1088	CHIP CAP.	0.1uF	16V	B	GRM188B11C104KA01D	K22124805		1-	A	H4
C 1089	CHIP CAP.	0.01uF	50V	B	GRM188B11H103KA01D	K22174823		1-	A	D2
C 1090	CHIP TA.CAP.	10uF	16V		TEESVB21C106M8R	K78120025		1-	A	D2
C 1091	CHIP TA.CAP.	1uF	35V		TEESVA1V105M8R	K78160032		1-	A	A5
C 1092	CHIP CAP.	150pF	50V	CH	GRM1882C1H151JA01D	K22174239		1-	A	D1
C 1093	CHIP CAP.	120pF	50V	CH	GRM1882C1H121JA01D	K22174237		1-	A	D1
C 1094	CHIP CAP.	180pF	50V	CH	GRM1882C1H181JA01D	K22174241		1-	A	C2
C 1095	CHIP CAP.	0.01uF	50V	B	GRM188B11H103KA01D	K22174823		1-	A	H4
C 1096	CHIP CAP.	0.01uF	50V	B	GRM188B11H103KA01D	K22174823		1-	A	H4
C 1097	CHIP CAP.	0.01uF	50V	B	GRM188B11H103KA01D	K22174823		1-	A	H3
C 1098	CHIP CAP.	0.01uF	50V	B	GRM188B11H103KA01D	K22174823		1-	A	H3
C 1101	CHIP CAP.	27pF	50V	CH	GRM1882C1H270JA01D	K22174221		1-	A	C2
C 1103	CHIP CAP.	68pF	50V	CH	GRM1882C1H680JA01D	K22174231		1-	A	H4
C 1104	CHIP CAP.	120pF	50V	CH	GRM1882C1H121JA01D	K22174237		1-	A	H3
C 1105	CHIP CAP.	270pF	50V	CH	GRM1882C1H271JA01D	K22174251		1-	A	H3
C 1107	CHIP CAP.	0.1uF	16V	B	GRM188B11C104KA01D	K22124805		1-	A	H4
C 1108	CHIP CAP.	0.1uF	16V	B	GRM188B11C104KA01D	K22124805		1-	A	H3
C 1002	CHIP CAP.	0.01uF	50V	B	GRM188B11H103KA01D	K22174823		1-	A	G1
C 1004	CHIP CAP.	0.01uF	50V	B	GRM188B11H103KA01D	K22174823		1-	A	C6
C 1005	CHIP CAP.	0.001uF	50V	B	GRM188B11H102KA01D	K22174821		1-	A	C6
C 1007	CHIP CAP.	0.01uF	50V	B	GRM188B11H103KA01D	K22174823		1-	A	A1
C 1008	CHIP CAP.	220pF	50V	CH	GRM1882C1H221JA01D	K22174243		1-	A	E6
C 1009	CHIP CAP.	0.001uF	50V	B	GRM188B11H102KA01D	K22174821		1-	A	C6
C 1010	CHIP CAP.	0.01uF	50V	B	GRM188B11H103KA01D	K22174823		1-	A	E6
C 1011	CHIP CAP.	220pF	50V	CH	GRM1882C1H221JA01D	K22174243		1-	A	E6
C 1012	CHIP CAP.	0.1uF	16V	B	GRM188B11C104KA01D	K22124805		1-	A	A2
C 1013	CHIP CAP.	220pF	50V	CH	GRM1882C1H221JA01D	K22174243		1-	A	E6
C 1014	CHIP CAP.	220pF	50V	CH	GRM1882C1H221JA01D	K22174243		1-	A	F6
C 1015	CHIP CAP.	220pF	50V	CH	GRM1882C1H221JA01D	K22174243		1-	A	E6
C 1016	CHIP CAP.	220pF	50V	CH	GRM1882C1H221JA01D	K22174243		1-	A	E6
C 1017	CHIP CAP.	0.001uF	50V	B	GRM188B11H102KA01D	K22174821		1-	A	F6
C 1018	CHIP CAP.	0.001uF	50V	B	GRM188B11H102KA01D	K22174821		1-	A	A2
C 1019	CHIP CAP.	0.001uF	50V	B	GRM188B11H102KA01D	K22174821		1-	A	F6
C 1020	CHIP CAP.	0.001uF	50V	B	GRM188B11H102KA01D	K22174821		1-	A	F6
C 1021	CHIP CAP.	220pF	50V	CH	GRM1882C1H221JA01D	K22174243		1-	A	E6
C 1022	CHIP CAP.	0.01uF	50V	B	GRM188B11H103KA01D	K22174823		1-	A	E6
C 1023	CHIP CAP.	220pF	50V	CH	GRM1882C1H221JA01D	K22174243		1-	A	E6
C 1024	CHIP CAP.	220pF	50V	CH	GRM1882C1H221JA01D	K22174243		1-	A	E6
C 1025	CHIP CAP.	220pF	50V	CH	GRM1882C1H221JA01D	K22174243		1-	A	E6
C 1026	CHIP CAP.	0.1uF	16V	B	GRM188B11C104KA01D	K22124805		1-	A	A2

MAIN Unit

Parts List

REF	DESCRIPTION	VALUE	V/W	TOL.	MFR'S DESIG	VXSTD P/N	VERS.	LOT	SIDE	LAY ADR
C 1028	CHIP CAP.	0.001uF	50V	B	GRM188B11H102KA01D	K22174821		1-	A	A2
C 1029	CHIP CAP.	100pF	50V	CH	GRM1882C1H101JA01D	K22174235		1-	A	F6
C 1030	CHIP CAP.	220pF	50V	CH	GRM1882C1H221JA01D	K22174243		1-	A	E6
C 1031	CHIP CAP.	220pF	50V	CH	GRM1882C1H221JA01D	K22174243		1-	A	F6
C 1032	CHIP CAP.	220pF	50V	CH	GRM1882C1H221JA01D	K22174243		1-	A	F6
C 1033	CHIP CAP.	0.001uF	50V	B	GRM188B11H102KA01D	K22174821		1-	A	F6
C 1035	CHIP CAP.	0.001uF	50V	B	GRM188B11H102KA01D	K22174821		1-	A	G6
C 1036	CHIP CAP.	0.001uF	50V	B	GRM188B11H102KA01D	K22174821		1-	A	G6
C 1037	CHIP CAP.	0.001uF	50V	B	GRM188B11H102KA01D	K22174821		1-	A	F6
C 1039	CHIP CAP.	27pF	50V	CH	GRM1882C1H270JA01D	K22174221		1-	A	B1
C 1040	CHIP CAP.	27pF	50V	CH	GRM1882C1H270JA01D	K22174221		1-	A	B1
C 1041	CHIP CAP.	0.1uF	16V	B	GRM188B11C104KA01D	K22124805		1-	A	C1
C 1042	CHIP CAP.	0.1uF	16V	B	GRM188B11C104KA01D	K22124805		1-	A	C1
C 1043	CHIP CAP.	0.01uF	50V	B	GRM188B11H103KA01D	K22174823		1-	A	H5
C 1044	CHIP CAP.	0.001uF	50V	B	GRM188B11H102KA01D	K22174821		1-	A	F6
C 1045	CHIP CAP.	0.01uF	50V	B	GRM188B11H103KA01D	K22174823		1-	A	C1
C 1046	CHIP CAP.	68pF	50V	CH	GRM1882C1H680JA01D	K22174231		1-	A	B1
C 1047	CHIP CAP.	0.1uF	16V	B	GRM188B11C104KA01D	K22124805		1-	A	C1
C 1048	CHIP CAP.	22pF	50V	CH	GRM1882C1H220JA01D	K22174219		1-	A	B1
C 1049	CHIP CAP.	0.001uF	50V	B	GRM188B11H102KA01D	K22174821		1-	A	F6
C 1050	CHIP TA.CAP.	10uF	16V		TEESVB21C106M8R	K78120025		1-	A	B1
C 1051	CHIP CAP.	0.1uF	16V	B	GRM188B11C104KA01D	K22124805		1-	A	C1
C 1052	CHIP CAP.	82pF	50V	CH	GRM1882C1H820JA01D	K22174233		1-	A	B1
C 1053	CHIP CAP.	100pF	50V	CH	GRM1882C1H101JA01D	K22174235		1-	A	F6
C 1054	CHIP CAP.	6pF	50V	CH	GRM1882C1H6R0DZ01D	K22174207		1-	A	B1
C 1109	CHIP CAP.	0.1uF	16V	B	GRM188B11C104KA01D	K22124805		1-	A	H3
C 1110	CHIP CAP.	0.1uF	16V	B	GRM188B11C104KA01D	K22124805		1-	A	H3
C 1111	CHIP CAP.	0.01uF	50V	B	GRM188B11H103KA01D	K22174823		1-	A	G6
C 1113	CHIP CAP.	2pF	50V	CK	GRM1884C1H2R0CZ01D	K22174203		1-	A	H4
C 1114	CHIP CAP.	22pF	50V	CH	GRM1882C1H220JA01D	K22174219		1-	A	H3
C 1115	CHIP CAP.	47pF	50V	CH	GRM1882C1H470JA01D	K22174227		1-	A	H3
C 1116	CHIP CAP.	0.1uF	16V	B	GRM188B11C104KA01D	K22124805		1-	A	D1
C 1117	CHIP CAP.	0.1uF	16V	B	GRM188B11C104KA01D	K22124805		1-	A	D1
C 1118	CHIP CAP.	0.1uF	16V	B	GRM188B11C104KA01D	K22124805		1-	A	C2
C 1120	CHIP CAP.	8pF	50V	CH	GRM1882C1H8R0DZ01D	K22174209		1-	A	D1
C 1123	CHIP CAP.	2pF	50V	CK	GRM1884C1H2R0CZ01D	K22174203		1-	A	H4
C 1125	CHIP CAP.	10pF	50V	CH	GRM1882C1H100JA01D	K22174211		1-	A	H3
C 1126	CHIP CAP.	0.1uF	16V	B	GRM188B11C104KA01D	K22124805		1-	A	H4
C 1127	CHIP CAP.	0.1uF	16V	B	GRM188B11C104KA01D	K22124805		1-	A	H3
C 1128	CHIP CAP.	0.1uF	16V	B	GRM188B11C104KA01D	K22124805		1-	A	H3
C 1129	CHIP CAP.	0.1uF	16V	B	GRM188B11C104KA01D	K22124805		1-	A	H3
C 1130	CHIP CAP.	0.01uF	50V	B	GRM188B11H103KA01D	K22174823		1-	A	D1
C 1131	CHIP CAP.	0.01uF	50V	B	GRM188B11H103KA01D	K22174823		1-	A	D1
C 1132	CHIP CAP.	0.01uF	50V	B	GRM188B11H103KA01D	K22174823		1-	A	C2
C 1133	CHIP CAP.	0.0018uF	50V	B	GRM188B11H182KA01D	K22174812		1-	A	D1
C 1134	CHIP CAP.	68pF	50V	CH	GRM1882C1H680JA01D	K22174231		1-	A	D1
C 1135	CHIP CAP.	15pF	50V	CH	GRM1882C1H150JA01D	K22174215		1-	A	D2
C 1136	CHIP CAP.	39pF	50V	CH	GRM1882C1H390JA01D	K22174225		1-	A	G5
C 1139	CHIP CAP.	68pF	50V	CH	GRM1882C1H680JA01D	K22174231		1-	A	H4
C 1140	CHIP CAP.	100pF	50V	CH	GRM1882C1H101JA01D	K22174235		1-	A	H3
C 1141	CHIP CAP.	82pF	50V	CH	GRM1882C1H820JA01D	K22174233		1-	A	H3
C 1142	CHIP TA.CAP.	4.7uF	16V		TEESVA1C475M8R	K78120031		1-	A	H4
C 1143	CHIP TA.CAP.	4.7uF	16V		TEESVA1C475M8R	K78120031		1-	A	H3
C 1144	CHIP TA.CAP.	4.7uF	16V		TEESVA1C475M8R	K78120031		1-	A	H3
C 1145	CHIP TA.CAP.	4.7uF	16V		TEESVA1C475M8R	K78120031		1-	A	H3
C 1146	CHIP CAP.	270pF	50V	CH	GRM1882C1H271JA01D	K22174251		1-	A	D1
C 1147	CHIP CAP.	180pF	50V	CH	GRM1882C1H181JA01D	K22174241		1-	A	D1
C 1148	CHIP CAP.	270pF	50V	CH	GRM1882C1H271JA01D	K22174251		1-	A	D2
C 1149	CHIP TA.CAP.	0.47uF	25V		TEESVA1E474M8R	K78140009		1-	A	A3
C 1152	CHIP CAP.	0.001uF	50V	CH	GRM40CH102J50PT	K22170288		1-	A	H4
C 1154	CHIP CAP.	27pF	50V	CH	GRM1882C1H270JA01D	K22174221		1-	A	D1
C 1155	CHIP CAP.	15pF	50V	CH	GRM1882C1H150JA01D	K22174215		1-	A	D1
C 1156	CHIP CAP.	47pF	50V	CH	GRM1882C1H470JA01D	K22174227		1-	A	D2
C 1158	CHIP CAP.	180pF	50V	CH	GRM1882C1H181JA01D	K22174241		1-	A	G4
C 1159	CHIP CAP.	390pF	50V	CH	GRM1882C1H391JA01D	K22174255		1-	A	G3
C 1160	CHIP CAP.	680pF	50V	CH	GRM1882C1H681JA01D	K22174274		1-	A	G3
C 1161	CHIP CAP.	82pF	50V	CH	GRM1882C1H820JA01D	K22174233		1-	A	G5
C 1163	CHIP CAP.	22pF	50V	CH	GRM1882C1H220JA01D	K22174219		1-	A	G4
C 1164	CHIP CAP.	120pF	50V	CH	GRM1882C1H121JA01D	K22174237		1-	A	G3
C 1165	CHIP CAP.	220pF	50V	CH	GRM1882C1H221JA01D	K22174243		1-	A	G3
C 1168	CHIP CAP.	820pF	25V	CH	GRM1882C1E821JA01D	K22144202		1-	A	H4
C 1170	CHIP CAP.	0.0018uF	50V	B	GRM188B11H182KA01D	K22174812		1-	A	D1
C 1171	CHIP CAP.	0.1uF	16V	B	GRM188B11C104KA01D	K22124805		1-	A	D1

MAIN Unit

Parts List

REF	DESCRIPTION	VALUE	V/W	TOL.	MFR'S DESIG	VXSTD P/N	VERS.	LOT	SIDE	LAY ADR
C 1172	CHIP CAP.	8pF	50V	CH	GRM1882C1H8R0DZ01D	K22174209		1-	A	D1
C 1173	CHIP CAP.	68pF	50V	CH	GRM1882C1H680JA01D	K22174231		1-	A	D1
C 1174	CHIP CAP.	0.1uF	16V	B	GRM188B11C104KA01D	K22124805		1-	A	D1
C 1176	CHIP CAP.	15pF	50V	CH	GRM1882C1H150JA01D	K22174215		1-	A	D2
C 1177	CHIP CAP.	0.1uF	16V	B	GRM188B11C104KA01D	K22124805		1-	A	D2
C 1178	CHIP CAP.	0.01uF	50V	B	GRM188B11H103KA01D	K22174823		1-	A	H4
C 1179	CHIP CAP.	0.01uF	50V	B	GRM188B11H103KA01D	K22174823		1-	A	H3
C 1180	CHIP CAP.	0.01uF	50V	B	GRM188B11H103KA01D	K22174823		1-	A	H3
C 1181	CHIP CAP.	0.01uF	50V	B	GRM188B11H103KA01D	K22174823		1-	A	H3
C 1182	CHIP TA.CAP.	1uF	35V		TEESVA1V105M8R	K78160032		1-	A	A5
C 1185	CHIP CAP.	2pF	50V	CK	GRM1884C1H2R0CZ01D	K22174203		1-	A	G4
C 1187	CHIP CAP.	10pF	50V	CH	GRM1882C1H100JA01D	K22174211		1-	A	G3
C 1189	CHIP CAP.	5pF	50V	CH	GRM1882C1H5R0CZ01D	K22174206		1-	A	G4
C 1190	CHIP CAP.	33pF	50V	CH	GRM1882C1H330JA01D	K22174223		1-	A	G3
C 1191	CHIP CAP.	68pF	50V	CH	GRM1882C1H680JA01D	K22174231		1-	A	G3
C 1192	CHIP CAP.	82pF	50V	CH	GRM1882C1H820JA01D	K22174233		1-	A	G5
C 1193	AL.ELECTRO.CAP.	47uF	16V		EEE1CA470WR	K48120025		1-	A	C2
C 1194	CHIP CAP.	820pF	25V	CH	GRM1882C1E821JA01D	K22144202		1-	A	H5
C 1197	CHIP CAP.	22pF	50V	CH	GRM1882C1H220JA01D	K22174219		1-	A	D2
C 1200	CHIP CAP.	68pF	50V	CH	GRM1882C1H680JA01D	K22174231		1-	A	G4
C 1201	CHIP CAP.	100pF	50V	CH	GRM1882C1H101JA01D	K22174235		1-	A	G3
C 1202	CHIP CAP.	82pF	50V	CH	GRM1882C1H820JA01D	K22174233		1-	A	G3
C 1204	CHIP CAP.	0.1uF	16V	B	GRM188B11C104KA01D	K22124805		1-	A	G4
C 1205	CHIP CAP.	0.1uF	16V	B	GRM188B11C104KA01D	K22124805		1-	A	G3
C 1206	CHIP CAP.	0.1uF	16V	B	GRM188B11C104KA01D	K22124805		1-	A	G3
C 1207	CHIP CAP.	0.1uF	16V	B	GRM188B11C104KA01D	K22124805		1-	A	G3
C 1208	AL.ELECTRO.CAP.	47uF	16V		EEE1CA470WR	K48120025		1-	A	C2
C 1210	CHIP CAP.	68pF	50V	CH	GRM1882C1H680JA01D	K22174231		1-	A	G4
C 1211	CHIP CAP.	120pF	50V	CH	GRM1882C1H121JA01D	K22174237		1-	A	G3
C 1212	CHIP CAP.	270pF	50V	CH	GRM1882C1H271JA01D	K22174251		1-	A	G3
C 1214	CHIP CAP.	150pF	50V	CH	GRM1882C1H151JA01D	K22174239		1-	A	D1
C 1215	CHIP CAP.	0.01uF	50V	B	GRM188B11H103KA01D	K22174823		1-	A	D1
C 1216	CHIP CAP.	120pF	50V	CH	GRM1882C1H121JA01D	K22174237		1-	A	D1
C 1217	CHIP CAP.	0.01uF	50V	B	GRM188B11H103KA01D	K22174823		1-	A	D1
C 1218	CHIP CAP.	180pF	50V	CH	GRM1882C1H181JA01D	K22174241		1-	A	D2
C 1219	CHIP CAP.	0.01uF	50V	B	GRM188B11H103KA01D	K22174823		1-	A	D2
C 1220	CHIP CAP.	0.01uF	50V	B	GRM188B11H103KA01D	K22174823		1-	A	B2
C 1221	CHIP CAP.	0.001uF	50V	B	GRM188B11H102KA01D	K22174821		1-	A	B2
C 1222	CHIP CAP.	0.1uF	16V	B	GRM188B11C104KA01D	K22124805		1-	A	C2
C 1223	CHIP CAP.	820pF	25V	CH	GRM1882C1E821JA01D	K22144202		1-	A	H5
C 1224	CHIP CAP.	0.01uF	50V	B	GRM188B11H103KA01D	K22174823		1-	A	G4
C 1225	CHIP CAP.	0.01uF	50V	B	GRM188B11H103KA01D	K22174823		1-	A	G4
C 1226	CHIP CAP.	0.01uF	50V	B	GRM188B11H103KA01D	K22174823		1-	A	G3
C 1227	CHIP CAP.	0.01uF	50V	B	GRM188B11H103KA01D	K22174823		1-	A	G3
C 1228	CHIP CAP.	0.1uF	16V	B	GRM188B11C104KA01D	K22124805		1-	A	D1
C 1229	CHIP CAP.	0.1uF	16V	B	GRM188B11C104KA01D	K22124805		1-	A	D1
C 1230	CHIP CAP.	0.1uF	16V	B	GRM188B11C104KA01D	K22124805		1-	A	D2
C 1231	CHIP CAP.	39pF	50V	CH	GRM1882C1H390JA01D	K22174225		1-	A	G5
C 1232	CHIP TA.CAP.	10uF	16V		TEESVB21C106M8R	K78120025		1-	A	B2
C 1234	CHIP CAP.	0.001uF	50V	CH	GRM40CH102J50PT	K22170288		1-	A	H5
C 1235	CHIP CAP.	0.001uF	50V	B	GRM188B11H102KA01D	K22174821		1-	A	D2
C 1236	CHIP CAP.	100pF	50V	CH	GRM1882C1H101JA01D	K22174235		1-	A	B2
C 1237	CHIP CAP.	0.01uF	50V	B	GRM188B11H103KA01D	K22174823		1-	A	H2
C 1238	CHIP CAP.	0.01uF	50V	B	GRM188B11H103KA01D	K22174823		1-	A	H2
C 1239	CHIP CAP.	0.01uF	50V	B	GRM188B11H103KA01D	K22174823		1-	A	H2
C 1240	CHIP CAP.	0.01uF	50V	B	GRM188B11H103KA01D	K22174823		1-	A	D2
C 1241	AL.ELECTRO.CAP.	47uF	16V		EEE1CA470SP	K48120005		1-	A	C4
C 1245	CHIP CAP.	220pF	50V	CH	GRM1882C1H221JA01D	K22174243		1-	A	H2
C 1246	CHIP CAP.	0.1uF	16V	B	GRM188B11C104KA01D	K22124805		1-	A	D2
C 1247	CHIP CAP.	0.1uF	16V	B	GRM188B11C104KA01D	K22124805		1-	A	D4
C 1248	CHIP CAP.	0.1uF	16V	B	GRM188B11C104KA01D	K22124805		1-	A	H2
C 1249	CHIP CAP.	0.1uF	16V	B	GRM188B11C104KA01D	K22124805		1-	A	H2
C 1250	CHIP CAP.	0.1uF	16V	B	GRM188B11C104KA01D	K22124805		1-	A	H1
C 1251	CHIP CAP.	0.01uF	50V	B	GRM188B11H103KA01D	K22174823		1-	A	H5
C 1252	CHIP CAP.	330pF	50V	CH	GRM1882C1H331JA01D	K22174253		1-	A	H2
C 1253	CHIP CAP.	820pF	50V	B	GRM188B11H821KA01D	K22174808		1-	A	H2
C 1254	CHIP CAP.	820pF	50V	B	GRM188B11H821KA01D	K22174808		1-	A	H2
C 1257	CHIP CAP.	0.0018uF	50V	B	GRM216B11H182KA01D	K22170808		1-	A	H5
C 1258	CHIP CAP.	33pF	50V	CH	GRM1882C1H330JA01D	K22174223		1-	A	H2
C 1259	CHIP CAP.	0.1uF	16V	B	GRM188B11C104KA01D	K22124805		1-	A	H2
C 1260	CHIP CAP.	22pF	50V	CH	GRM1882C1H220JA01D	K22174219		1-	A	H2
C 1261	CHIP CAP.	0.1uF	16V	B	GRM188B11C104KA01D	K22124805		1-	A	H2
C 1262	CHIP CAP.	180pF	50V	CH	GRM1882C1H181JA01D	K22174241		1-	A	H2

MAIN Unit

Parts List

REF	DESCRIPTION	VALUE	V/W	TOL.	MFR'S DESIG	VXSTD P/N	VERS.	LOT	SIDE	LAY ADR
C 1263	CHIP CAP.	0.1uF	16V	B	GRM188B11C104KA01D	K22124805		1-	A	H1
C 1264	CHIP TA.CAP.	0.22uF	35V		TEESVA1V224M8R	K78160027		1-	A	B2
C 1265	CHIP CAP.	0.1uF	16V	B	GRM188B11C104KA01D	K22124805		1-	A	C2
C 1267	CHIP CAP.	270pF	50V	CH	GRM1882C1H271JA01D	K22174251		1-	A	H2
C 1268	CHIP CAP.	270pF	50V	CH	GRM1882C1H271JA01D	K22174251		1-	A	H2
C 1269	CHIP CAP.	680pF	50V	CH	GRM1882C1H681JA01D	K22174274		1-	A	H2
C 1271	CHIP CAP.	0.1uF	16V	B	GRM188B11C104KA01D	K22124805		1-	A	D4
C 1272	AL.ELECTRO.CAP.	100uF	16V		EEE1CA101WP	K48120012		1-	A	B2
C 1273	CHIP CAP.	820pF	50V	B	GRM188B11H821KA01D	K22174808		1-	A	G2
C 1274	CHIP TA.CAP.	4.7uF	16V		TEESVA1C475M8R	K78120031		1-	A	H2
C 1275	CHIP TA.CAP.	4.7uF	16V		TEESVA1C475M8R	K78120031		1-	A	H2
C 1276	CHIP TA.CAP.	4.7uF	16V		TEESVA1C475M8R	K78120031		1-	A	H1
C 1277	CHIP CAP.	0.0027uF	50V	B	GRM188B11H272KA01D	K22174814		1-	A	G2
C 1278	CHIP CAP.	0.0027uF	50V	B	GRM188B11H272KA01D	K22174814		1-	A	G2
C 1280	CHIP CAP.	0.01uF	50V	B	GRM188B11H103KA01D	K22174823		1-	A	C5
C 1281	CHIP CAP.	0.0033uF	50V	B	GRM216B11H332KA01D	K22170811		1-	A	G5
C 1282	CHIP CAP.	100pF	50V	CH	GRM1882C1H101JA01D	K22174235		1-	A	D4
C 1283	AL.ELECTRO.CAP.	47uF	16V		EEE1CA470SP	K48120005		1-	A	D4
C 1284	CHIP CAP.	100pF	50V	CH	GRM1882C1H101JA01D	K22174235		1-	A	D4
C 1285	CHIP CAP.	100pF	50V	CH	GRM1882C1H101JA01D	K22174235		1-	A	G2
C 1286	CHIP CAP.	180pF	50V	CH	GRM1882C1H181JA01D	K22174241		1-	A	G2
C 1287	CHIP CAP.	100pF	50V	CH	GRM1882C1H101JA01D	K22174235		1-	A	G2
C 1288	AL.ELECTRO.CAP.	22uF	16V		EEE1CA220SR	K48120024		1-	A	C5
C 1289	CHIP TA.CAP.	10uF	16V		TEESVA1C106M8R	K78120077		1-	A	C5
C 1291	CHIP CAP.	0.1uF	16V	B	GRM188B11C104KA01D	K22124805		1-	A	D4
C 1292	CHIP CAP.	0.01uF	50V	B	GRM188B11H103KA01D	K22174823		1-	A	H2
C 1293	CHIP CAP.	0.01uF	50V	B	GRM188B11H103KA01D	K22174823		1-	A	H2
C 1294	CHIP CAP.	0.01uF	50V	B	GRM188B11H103KA01D	K22174823		1-	A	H1
C 1295	CHIP TA.CAP.	10uF	16V		TEESVB21C106M8R	K78120025		1-	A	B2
C 1296	CHIP CAP.	0.0018uF	50V	B	GRM216B11H182KA01D	K22170808		1-	A	G5
C 1297	CHIP CAP.	33pF	50V	CH	GRM1882C1H330JA01D	K22174223		1-	A	G2
C 1298	CHIP CAP.	22pF	50V	CH	GRM1882C1H220JA01D	K22174219		1-	A	G2
C 1299	CHIP CAP.	180pF	50V	CH	GRM1882C1H181JA01D	K22174241		1-	A	G2
C 1300	CHIP CAP.	0.01uF	50V	B	GRM188B11H103KA01D	K22174823		1-	A	B2
C 1301	CHIP CAP.	0.001uF	50V	B	GRM188B11H102KA01D	K22174821		1-	A	D3
C 1303	CHIP CAP.	270pF	50V	CH	GRM1882C1H271JA01D	K22174251		1-	A	G2
C 1304	CHIP CAP.	270pF	50V	CH	GRM1882C1H271JA01D	K22174251		1-	A	G2
C 1305	CHIP CAP.	680pF	50V	CH	GRM1882C1H681JA01D	K22174274		1-	A	G2
C 1306	CHIP CAP.	0.018uF	50V	B	GRM40B183M50PT	K22170820		1-	A	G5
C 1307	CHIP CAP.	0.1uF	25V	B	GRM21BB11E104KA01L	K22140811		1-	A	G5
C 1308	CHIP CAP.	330pF	50V	CH	GRM1882C1H331JA01D	K22174253		1-	A	G2
C 1309	CHIP CAP.	820pF	50V	B	GRM188B11H821KA01D	K22174808		1-	A	G2
C 1310	CHIP CAP.	820pF	50V	B	GRM188B11H821KA01D	K22174808		1-	A	G2
C 1311	CHIP CAP.	0.1uF	16V	B	GRM188B11C104KA01D	K22124805		1-	A	D3
C 1312	CHIP CAP.	0.1uF	16V	B	GRM188B11C104KA01D	K22124805		1-	A	G2
C 1313	CHIP CAP.	0.1uF	16V	B	GRM188B11C104KA01D	K22124805		1-	A	G2
C 1314	CHIP CAP.	0.1uF	16V	B	GRM188B11C104KA01D	K22124805		1-	A	G1
C 1317	CHIP CAP.	220pF	50V	CH	GRM1882C1H221JA01D	K22174243		1-	A	G2
C 1318	CHIP CAP.	39pF	50V	CH	GRM1882C1H390JA01D	K22174225		1-	A	D3
C 1319	CHIP TA.CAP.	1uF	35V		TEESVA1V105M8R	K78160032		1-	A	C4
C 1320	CHIP TA.CAP.	1uF	35V		TEESVA1V105M8R	K78160032		1-	A	C4
C 1321	CHIP CAP.	8pF	50V	CH	GRM1882C1H8R0DZ01D	K22174209		1-	A	D3
C 1322	CHIP CAP.	0.01uF	50V	B	GRM188B11H103KA01D	K22174823		1-	A	D3
C 1323	CHIP CAP.	0.018uF	50V	B	GRM40B183M50PT	K22170820		1-	A	G5
C 1324	CHIP CAP.	0.1uF	25V	B	GRM21BB11E104KA01L	K22140811		1-	A	G5
C 1325	CHIP CAP.	0.1uF	16V	B	GRM188B11C104KA01D	K22124805		1-	A	F2
C 1326	CHIP CAP.	0.01uF	50V	B	GRM188B11H103KA01D	K22174823		1-	A	G2
C 1327	CHIP CAP.	0.01uF	50V	B	GRM188B11H103KA01D	K22174823		1-	A	G2
C 1328	CHIP CAP.	0.01uF	50V	B	GRM188B11H103KA01D	K22174823		1-	A	G2
C 1329	CHIP CAP.	820pF	50V	B	GRM188B11H821KA01D	K22174808		1-	A	C5
C 1330	CHIP CAP.	82pF	50V	CH	GRM1882C1H820JA01D	K22174233		1-	A	D3
C 1331	CHIP CAP.	0.1uF	16V	B	GRM188B11C104KA01D	K22124805		1-	A	G4
C 1332	CHIP CAP.	0.015uF	50V	B	GRM188B11H153KA01D	K22174838		1-	A	C5
C 1334	CHIP CAP.	0.001uF	50V	B	GRM188B11H102KA01D	K22174821		1-	A	F1
C 1335	CHIP CAP.	0.01uF	50V	B	GRM188B11H103KA01D	K22174823		1-	A	F1
C 1336	CHIP CAP.	0.1uF	16V	B	GRM188B11C104KA01D	K22124805		1-	A	F1
C 1337	CHIP CAP.	0.001uF	50V	B	GRM188B11H102KA01D	K22174821		1-	A	D3
C 1338	CHIP CAP.	39pF	50V	CH	GRM1882C1H390JA01D	K22174225		1-	A	D3
C 1339	CHIP CAP.	47pF	50V	CH	GRM1882C1H470JA01D	K22174227		1-	A	D4
C 1340	CHIP TA.CAP.	1uF	16V		TEESVA1C105M8R	K78120009		1-	A	C5
C 1341	CHIP CAP.	47pF	50V	CH	GRM1882C1H470JA01D	K22174227		1-13	A	D4
C 1342	CHIP CAP.	0.1uF	16V	B	GRM188B11C104KA01D	K22124805		1-	A	F1
C 1343	CHIP CAP.	0.001uF	50V	B	GRM188B11H102KA01D	K22174821		1-	A	F1

MAIN Unit

Parts List

REF	DESCRIPTION	VALUE	V/W	TOL.	MFR'S DESIG	VXSTD P/N	VERS.	LOT	SIDE	LAY ADR
C 1344	CHIP CAP.	15pF	50V	CH	GRM1882C1H150JA01D	K22174215		1-	A	E3
C 1345	CHIP CAP.	0.01uF	50V	B	GRM188B11H103KA01D	K22174823		1-	A	E3
C 1346	AL.ELECTRO.CAP.	220uF	10V		RV3-10V221MF80-R	K48100002		1-	A	C4
C 1347	CHIP TA.CAP.	10uF	16V		TEESVB21C106M8R	K78120025		1-	A	D3
C 1348	CHIP CAP.	0.01uF	50V	B	GRM188B11H103KA01D	K22174823		1-	A	C4
C 1349	CHIP CAP.	0.1uF	16V	B	GRM188B11C104KA01D	K22124805		1-	A	F1
C 1350	AL.ELECTRO.CAP.	10uF	16V		RV4-16V100MD46-RR2	K48120018		1-	A	F2
C 1351	CHIP CAP.	0.1uF	16V	B	GRM188B11C104KA01D	K22124805		1-	A	E4
C 1352	CHIP CAP.	0.01uF	50V	B	GRM188B11H103KA01D	K22174823		1-	A	D3
C 1353	CHIP CAP.	0.001uF	50V	B	GRM188B11H102KA01D	K22174821		1-	A	F1
C 1354	CHIP CAP.	0.1uF	16V	B	GRM188B11C104KA01D	K22124805		1-	A	F2
C 1355	CHIP CAP.	0.001uF	50V	B	GRM188B11H102KA01D	K22174821		1-	A	F1
C 1356	CHIP CAP.	0.001uF	50V	B	GRM188B11H102KA01D	K22174821		1-	A	E3
C 1357	CHIP CAP.	0.0056uF	50V	B	GRM188B11H562KA01D	K22174818		1-	A	C5
C 1358	CHIP CAP.	0.1uF	16V	B	GRM188B11C104KA01D	K22124805		1-	A	F1
C 1359	CHIP CAP.	47pF	50V	CH	GRM1882C1H470JA01D	K22174227		1-	A	D4
C 1360	CHIP CAP.	0.01uF	50V	B	GRM188B11H103KA01D	K22174823		1-	A	D3
C 1361	CHIP CAP.	0.01uF	50V	B	GRM188B11H103JA01D	K22174824		1-	A	F1
C 1362	CHIP CAP.	0.1uF	16V	B	GRM188B11C104KA01D	K22124805		1-	A	F1
C 1363	CHIP TA.CAP.	1uF	35V		TEESVA1V105M8R	K78160032		1-	A	C3
C 1364	AL.ELECTRO.CAP.	220uF	10V		RV3-10V221MF80-R	K48100002		1-	A	C4
C 1365	CHIP CAP.	0.1uF	16V	B	GRM188B11C104KA01D	K22124805		1-	A	E1
C 1367	CHIP CAP.	0.1uF	16V	B	GRM188B11C104KA01D	K22124805		1-	A	F1
C 1368	CHIP CAP.	0.001uF	50V	B	GRM188B11H102KA01D	K22174821		1-	A	F1
C 1369	CHIP TA.CAP.	1uF	16V		TEESVA1C105M8R	K78120009		1-	A	C5
C 1370	AL.ELECTRO.CAP.	220uF	16V		EMVA160ADA221MF80G	K48120021		1-	A	C4
C 1371	CHIP CAP.	0.1uF	16V	B	GRM188B11C104KA01D	K22124805		1-	A	E4
C 1372	CHIP TA.CAP.	10uF	16V		TEESVA1C106M8R	K78120077		1-	A	D5
C 1373	CHIP CAP.	10pF	50V	CH	GRM1882C1H100JA01D	K22174211		1-	A	D3
C 1374	CHIP CAP.	220pF	50V	CH	GRM1882C1H221JA01D	K22174243		1-	A	D4
C 1375	CHIP TA.CAP.	10uF	16V		TEESVB21C106M8R	K78120025		1-	A	E4
C 1376	CHIP CAP.	0.01uF	50V	B	GRM188B11H103KA01D	K22174823		1-	A	E1
C 1377	CHIP CAP.	0.1uF	16V	B	GRM188B11C104KA01D	K22124805		1-	A	D5
C 1378	CHIP CAP.	0.047uF	25V	B	GRM188B11E473KA01D	K22144811		1-	A	C3
C 1380	CHIP CAP.	0.01uF	50V	B	GRM188B11H103KA01D	K22174823		1-	A	D3
C 1381	CHIP CAP.	0.1uF	16V	B	GRM188B11C104KA01D	K22124805		1-	A	F1
C 1382	CHIP CAP.	0.022uF	50V	B	GRM216B11H223KA01D	K22170821		1-	A	D5
C 1384	CHIP CAP.	0.01uF	50V	B	GRM188B11H103KA01D	K22174823		1-	A	D3
C 1385	CHIP CAP.	0.01uF	50V	B	GRM188B11H103KA01D	K22174823		1-	A	D3
C 1387	CHIP CAP.	0.1uF	16V	B	GRM188B11C104KA01D	K22124805		1-	A	C4
C 1388	CHIP CAP.	0.001uF	50V	B	GRM188B11H102KA01D	K22174821		1-	A	F1
C 1389	AL.ELECTRO.CAP.	47uF	16V		EEE1CA470WR	K48120025		1-	A	C3
C 1390	CHIP CAP.	56pF	50V	CH	GRM1882C1H560JA01D	K22174229		1-	A	D5
C 1391	CHIP CAP.	47pF	50V	CH	GRM1882C1H470JA01D	K22174227		1-	A	D4
C 1392	CHIP CAP.	0.001uF	50V	B	GRM188B11H102KA01D	K22174821		1-	A	F1
C 1393	CHIP CAP.	0.1uF	16V	B	GRM188B11C104KA01D	K22124805		1-	A	F1
C 1394	CHIP CAP.	18pF	50V	CH	GRM1882C1H180JA01D	K22174217		1-	A	D3
C 1395	CHIP CAP.	0.01uF	50V	B	GRM188B11H103KA01D	K22174823		1-	A	D3
C 1396	CHIP CAP.	0.001uF	50V	B	GRM188B11H102KA01D	K22174821		1-	A	C4
C 1399	CHIP CAP.	0.1uF	16V	B	GRM188B11C104KA01D	K22124805		1-	A	F1
C 1400	CHIP CAP.	0.01uF	50V	B	GRM188B11H103KA01D	K22174823		1-	A	B4
C 1401	CHIP CAP.	0.1uF	16V	B	GRM188B11C104KA01D	K22124805		1-	A	F1
C 1402	CHIP CAP.	0.001uF	50V	B	GRM188B11H102KA01D	K22174821		1-	A	D3
C 1403	AL.ELECTRO.CAP.	47uF	16V		EEE1CA470WR	K48120025		1-	A	B4
C 1404	CHIP CAP.	0.047uF	25V	B	GRM188B11E473KA01D	K22144811		1-	A	C3
C 1405	CHIP CAP.	0.001uF	50V	B	GRM188B11H102KA01D	K22174821		1-	A	F2
C 1406	CHIP CAP.	0.01uF	50V	B	GRM188B11H103KA01D	K22174823		1-	A	F2
C 1407	CHIP CAP.	0.1uF	16V	B	GRM188B11C104KA01D	K22124805		1-	A	F2
C 1409	CHIP CAP.	0.01uF	50V	B	GRM188B11H103JA01D	K22174824		1-	A	F1
C 1410	CHIP CAP.	0.01uF	50V	B	GRM188B11H103KA01D	K22174823		1-	A	D3
C 1411	CHIP TA.CAP.	1uF	35V		TEESVA1V105M8R	K78160032		1-	A	C3
C 1412	CHIP CAP.	10pF	50V	CH	GRM1882C1H100JA01D	K22174211		1-	A	D3
C 1413	CHIP TA.CAP.	0.1uF	35V		TEESVA1V104M8R	K78160025		1-	A	B4
C 1414	CHIP CAP.	0.012uF	50V	B	GRM188B11H123KA01D	K22174825		1-8	A	D6
C 1416	CHIP CAP.	0.01uF	50V	B	GRM188B11H103KA01D	K22174823		1-	A	C4
C 1417	CHIP CAP.	0.01uF	50V	B	GRM188B11H103KA01D	K22174823		1-	A	G2
C 1418	CHIP TA.CAP.	0.1uF	35V		TEESVA1V104M8R	K78160025		1-	A	B4
C 1419	CHIP CAP.	15pF	50V	CH	GRM1882C1H150JA01D	K22174215		1-	A	D3
C 1421	CHIP TA.CAP.	1uF	35V		TEESVA1V105M8R	K78160032		1-	A	D4
C 1422	CHIP CAP.	150pF	50V	CH	GRM1882C1H151JA01D	K22174239		1-	A	F2
C 1423	CHIP TA.CAP.	10uF	16V		TEESVA1C106M8R	K78120077		1-	A	D5
C 1424	AL.ELECTRO.CAP.	47uF	16V		EEE1CA470WR	K48120025		1-	A	B4
C 1425	CHIP CAP.	0.001uF	50V	B	GRM188B11H102KA01D	K22174821		1-	A	C3

MAIN Unit

Parts List

REF	DESCRIPTION	VALUE	V/W	TOL.	MFR'S DESIG	VXSTD P/N	VERS.	LOT	SIDE	LAY ADR
C 1426	CHIP CAP.	0.1uF	16V	B	GRM188B11C104KA01D	K22124805		1-	A	G2
C 1427	CHIP TA.CAP.	0.22uF	35V		TEESVA1V224M8R	K78160027		1-	A	D4
C 1428	CHIP CAP.	390pF	50V	CH	GRM1882C1H391JA01D	K22174255		1-	A	E2
C 1429	CHIP CAP.	150pF	50V	CH	GRM1882C1H151JA01D	K22174239		1-	A	E2
C 1430	CHIP CAP.	68pF	50V	CH	GRM1882C1H680JA01D	K22174231		1-	A	E2
C 1432	CHIP CAP.	0.1uF	16V	B	GRM188B11C104KA01D	K22124805		1-	A	D5
C 1433	CHIP TA.CAP.	0.47uF	35V		TEESVA1V474M8R	K78160029		1-	A	B5
C 1434	CHIP CAP.	120pF	50V	CH	GRM1882C1H121JA01D	K22174237		1-	A	F2
C 1435	CHIP CAP.	0.0022uF	50V	B	GRM188B11H222KA01D	K22174822		1-	A	E6
C 1435	CHIP CAP.	0.0047uF	50V	B	GRM188B11H472KA01D	K22174833		9-	A	E6
C 1436	CHIP CAP.	0.01uF	50V	B	GRM188B11H103KA01D	K22174823		1-	A	D4
C 1437	CHIP CAP.	0.001uF	50V	B	GRM188B11H102KA01D	K22174821		1-	A	C3
C 1438	CHIP CAP.	47pF	50V	CH	GRM1882C1H470JA01D	K22174227		1-	A	E2
C 1439	CHIP CAP.	27pF	50V	CH	GRM1882C1H270JA01D	K22174221		1-	A	E2
C 1440	CHIP CAP.	33pF	50V	CH	GRM1882C1H330JA01D	K22174223		1-	A	E2
C 1441	CHIP CAP.	100pF	50V	CH	GRM1882C1H101JA01D	K22174235		1-	A	E2
C 1443	CHIP CAP.	0.1uF	16V	B	GRM188B11C104KA01D	K22124805		1-	A	D4
C 1444	CHIP CAP.	0.1uF	16V	B	GRM188B11C104KA01D	K22124805		1-	A	C3
C 1445	CHIP CAP.	0.001uF	50V	B	GRM188B11H102KA01D	K22174821		1-	A	D5
C 1446	CHIP CAP.	100pF	50V	CH	GRM1882C1H101JA01D	K22174235		1-	A	F2
C 1447	CHIP TA.CAP.	1uF	35V		TEESVA1V105M8R	K78160032		1-	A	D4
C 1449	AL.ELECTRO.CAP.	100uF	16V		EEE1CA101WP	K48120012		1-	A	D3
C 1450	CHIP CAP.	22pF	50V	CH	GRM1882C1H220JA01D	K22174219		1-	A	C3
C 1451	CHIP CAP.	0.001uF	50V	B	GRM188B11H102KA01D	K22174821		1-	A	F2
C 1452	CHIP CAP.	0.01uF	50V	B	GRM188B11H103KA01D	K22174823		1-	A	D4
C 1453	CHIP CAP.	0.001uF	50V	B	GRM188B11H102KA01D	K22174821		1-	A	D5
C 1454	CHIP TA.CAP.	4.7uF	16V		TEESVA1C475M8R	K78120031		1-	A	B5
C 1454	CHIP TA.CAP.	0.47uF	35V		TEESVA1V474M8R	K78160029		3-	A	B5
C 1455	CHIP CAP.	0.01uF	50V	B	GRM188B11H103KA01D	K22174823		1-	A	F2
C 1456	CHIP CAP.	0.001uF	50V	B	GRM188B11H102KA01D	K22174821		1-	A	E3
C 1457	CHIP TA.CAP.	0.1uF	35V		TEESVA1V104M8R	K78160025		1-	A	B5
C 1458	CHIP CAP.	0.001uF	50V	B	GRM188B11H102KA01D	K22174821		1-	A	D5
C 1459	CHIP CAP.	0.1uF	16V	B	GRM188B11C104KA01D	K22124805		1-	A	F2
C 1460	CHIP TA.CAP.	10uF	16V		TEESVA1C106M8R	K78120077		1-	A	E5
C 1461	CHIP CAP.	47pF	50V	CH	GRM1882C1H470JA01D	K22174227		1-	A	D4
C 1462	CHIP CAP.	0.1uF	16V	B	GRM188B11C104KA01D	K22124805		1-	A	C3
C 1463	CHIP CAP.	0.01uF	50V	B	GRM188B11H103KA01D	K22174823		1-	A	B5
C 1464	CHIP TA.CAP.	10uF	16V		TEESVA1C106M8R	K78120077		1-	A	D4
C 1465	CHIP TA.CAP.	0.1uF	35V		TEESVA1V104M8R	K78160025		1-	A	B5
C 1466	CHIP CAP.	0.0022uF	50V	B	GRM188B11H222KA01D	K22174822		1-8	A	E6
C 1467	CHIP CAP.	0.1uF	16V	B	GRM188B11C104KA01D	K22124805		1-	A	F2
C 1468	CHIP CAP.	0.001uF	50V	B	GRM188B11H102KA01D	K22174821		1-	A	F2
C 1469	CHIP CAP.	0.001uF	50V	B	GRM188B11H102KA01D	K22174821		1-	A	F2
C 1470	CHIP CAP.	0.1uF	16V	B	GRM188B11C104KA01D	K22124805		1-	A	F2
C 1471	CHIP CAP.	0.1uF	16V	B	GRM188B11C104KA01D	K22124805		1-	A	E5
C 1472	CHIP CAP.	0.022uF	50V	B	GRM188B11H223KA01D	K22174839		1-	A	D5
C 1473	CHIP CAP.	0.01uF	50V	B	GRM188B11H103KA01D	K22174823		1-	A	D4
C 1474	CHIP CAP.	2pF	50V	CK	GRM1884C1H2ROCZ01D	K22174203		1-	A	E2
C 1475	CHIP CAP.	0.1uF	16V	B	GRM188B11C104KA01D	K22124805		1-	A	B3
C 1476	CHIP CAP.	27pF	50V	CH	GRM1882C1H270JA01D	K22174221		1-	A	E2
C 1478	CHIP CAP.	0.01uF	50V	B	GRM188B11H103KA01D	K22174823		1-	A	E4
C 1479	CHIP CAP.	0.01uF	50V	B	GRM188B11H103KA01D	K22174823		1-	A	D5
C 1480	CHIP CAP.	0.01uF	50V	B	GRM188B11H103KA01D	K22174823		1-	A	E3
C 1482	CHIP CAP.	56pF	50V	CH	GRM1882C1H560JA01D	K22174229		1-	A	E2
C 1483	CHIP CAP.	0.01uF	50V	B	GRM188B11H103KA01D	K22174823		1-	A	E5
C 1485	CHIP CAP.	0.1uF	16V	B	GRM188B11C104KA01D	K22124805		1-	A	B6
C 1486	CHIP CAP.	15pF	50V	CH	GRM1882C1H150JA01D	K22174215		1-	A	E3
C 1487	CHIP CAP.	22pF	50V	CH	GRM1882C1H220JA01D	K22174219		1-	A	F2
C 1488	CHIP CAP.	27pF	50V	CH	GRM1882C1H270JA01D	K22174221		1-	A	E2
C 1490	CHIP CAP.	10pF	50V	CH	GRM1882C1H100JA01D	K22174211		1-	A	E2
C 1491	CHIP CAP.	0.1uF	16V	B	GRM188B11C104KA01D	K22124805		1-	A	B3
C 1493	CHIP CAP.	22pF	50V	CH	GRM1882C1H220JA01D	K22174219		1-	A	F2
C 1495	CHIP CAP.	0.01uF	50V	B	GRM188B11H103KA01D	K22174823		1-	A	E2
C 1497	CHIP CAP.	0.01uF	50V	B	GRM188B11H103KA01D	K22174823		1-	A	B5
C 1499	CHIP TA.CAP.	0.1uF	35V		TEESVA1V104M8R	K78160025		1-	A	B6
C 1500	CHIP TA.CAP.	1uF	35V		TEESVA1V105M8R	K78160032		1-	A	E1
C 1501	CHIP CAP.	330pF	50V	CH	GRM1882C1H331JA01D	K22174253		1-	A	E6
C 1501	CHIP CAP.	0.0033uF	50V	B	GRM188B11H332KA01D	K22174815		9-	A	E6
C 1502	CHIP CAP.	0.01uF	50V	B	GRM188B11H103KA01D	K22174823		1-	A	E4
C 1503	CHIP CAP.	0.001uF	50V	B	GRM188B11H102KA01D	K22174821		1-	A	F2
C 1504	CHIP CAP.	470pF	50V	CH	GRM1882C1H471JA01D	K22174249		1-	A	E2
C 1506	CHIP CAP.	0.1uF	16V	B	GRM188B11C104KA01D	K22124805		1-	A	F2
C 1507	CHIP TA.CAP.	1uF	35V		TEESVA1V105M8R	K78160032		1-	A	E5

MAIN Unit

Parts List

REF	DESCRIPTION	VALUE	V/W	TOL.	MFR'S DESIG	VXSTD P/N	VERS.	LOT	SIDE	LAY ADR
C 1507	CHIP TA.CAP.	0.1uF	35V		TEESVA1V104M8R	K78160025		9-	A	E5
C 1508	CHIP CAP.	0.001uF	50V	B	GRM188B11H102KA01D	K22174821		1-	A	E4
C 1510	CHIP CAP.	0.01uF	50V	B	GRM188B11H103KA01D	K22174823		1-	A	E4
C 1511	CHIP CAP.	0.001uF	50V	B	GRM188B11H102KA01D	K22174821		1-	A	F2
C 1512	CHIP TA.CAP.	10uF	10V		TEESVB21A106M8R	K78100017		1-	A	F2
C 1513	CHIP CAP.	0.01uF	50V	B	GRM188B11H103KA01D	K22174823		1-	A	E5
C 1514	CHIP CAP.	0.01uF	50V	B	GRM188B11H103KA01D	K22174823		1-	A	B5
C 1515	CHIP CAP.	0.1uF	16V	B	GRM188B11C104KA01D	K22124805		1-	A	F2
C 1516	AL.ELECTRO.CAP.	100uF	16V		EEE1CA101WP	K48120012		1-	A	E1
C 1517	CHIP CAP.	0.1uF	16V	B	GRM188B11C104KA01D	K22124805		1-	A	E6
C 1518	CHIP CAP.	0.01uF	50V	B	GRM188B11H103KA01D	K22174823		1-	A	E1
C 1519	CHIP TA.CAP.	1uF	35V		TEESVA1V105M8R	K78160032		1-	A	B5
C 1520	CHIP CAP.	0.01uF	50V	B	GRM188B11H103KA01D	K22174823		1-	A	E1
C 1521	CHIP CAP.	0.01uF	50V	B	GRM188B11H103KA01D	K22174823		1-	A	E4
C 1522	CHIP TA.CAP.	10uF	10V		TEESVB21A106M8R	K78100017		1-	A	F2
C 1523	CHIP CAP.	2pF	50V	CK	GRM1884C1H2R0CZ01D	K22174203		1-	A	F3
C 1524	CHIP TA.CAP.	10uF	16V		TEESVA1C106M8R	K78120077		1-	A	E1
C 1525	CHIP CAP.	15pF	50V	CH	GRM1882C1H150JA01D	K22174215		1-	A	E3
C 1526	CHIP CAP.	0.01uF	50V	B	GRM188B11H103JA01D	K22174824		1-	A	E3
C 1527	CHIP CAP.	0.1uF	16V	B	GRM188B11C104KA01D	K22124805		1-	A	F5
C 1528	CHIP CAP.	0.1uF	16V	B	GRM188B11C104KA01D	K22124805		1-	A	E5
C 1529	CHIP CAP.	0.001uF	50V	B	GRM188B11H102KA01D	K22174821		1-	A	C5
C 1530	CHIP CAP.	0.001uF	50V	B	GRM188B11H102KA01D	K22174821		1-	A	C5
C 1531	CHIP CAP.	0.001uF	50V	B	GRM188B11H102KA01D	K22174821		1-	A	E4
C 1532	CHIP CAP.	0.001uF	50V	B	GRM188B11H102KA01D	K22174821		1-	A	E2
C 1533	CHIP CAP.	100pF	50V	CH	GRM1882C1H101JA01D	K22174235		1-	A	E5
C 1534	CHIP CAP.	0.01uF	50V	B	GRM188B11H103KA01D	K22174823		1-	A	E4
C 1535	CHIP TA.CAP.	10uF	16V		TEESVA1C106M8R	K78120077		1-	A	E5
C 1536	CHIP CAP.	6pF	50V	CH	GRM1882C1H6R0DZ01D	K22174207		1-	A	E4
C 1537	CHIP CAP.	56pF	50V	CH	GRM1882C1H560JA01D	K22174229		1-	A	E4
C 1538	CHIP TA.CAP.	10uF	16V		TEESVA1C106M8R	K78120077		1-	A	F5
C 1539	CHIP CAP.	2pF	50V	CK	GRM1884C1H2R0CZ01D	K22174203		1-	A	E4
C 1540	CHIP CAP.	12pF	50V	CH	GRM1882C1H120JA01D	K22174213		1-	A	E4
C 1541	CHIP CAP.	0.01uF	50V	B	GRM188B11H103KA01D	K22174823		1-	A	C5
C 1542	CHIP CAP.	0.1uF	16V	B	GRM188B11C104KA01D	K22124805		1-	A	E6
C 1543	CHIP CAP.	0.01uF	50V	B	GRM188B11H103KA01D	K22174823		1-	A	F3
C 1544	CHIP CAP.	4pF	50V	CH	GRM1882C1H4R0CZ01D	K22174205		1-	A	F3
C 1545	CHIP CAP.	3pF	50V	CJ	GRM1883C1H3R0CZ01D	K22174204		1-	A	E4
C 1546	CHIP CAP.	0.001uF	50V	B	GRM188B11H102KA01D	K22174821		1-	A	E2
C 1547	CHIP TA.CAP.	1uF	35V		TEESVA1V105M8R	K78160032		1-	A	B5
C 1548	CHIP CAP.	27pF	50V	CH	GRM1882C1H270JA01D	K22174221		1-	A	E5
C 1549	CHIP CAP.	0.1uF	16V	B	GRM188B11C104KA01D	K22124805		1-	A	E5
C 1550	CHIP TA.CAP.	1uF	35V		TEESVA1V105M8R	K78160032		1-	A	C4
C 1551	CHIP CAP.	0.01uF	50V	B	GRM188B11H103KA01D	K22174823		1-	A	E4
C 1552	CHIP CAP.	82pF	50V	CH	GRM1882C1H820JA01D	K22174233		1-	A	E5
C 1553	CHIP CAP.	0.01uF	50V	B	GRM188B11H103KA01D	K22174823		1-	A	F3
C 1554	CHIP TA.CAP.	1uF	25V		TEESVA1E105M8R	K78140013		1-	A	C6
C 1555	CHIP TA.CAP.	1uF	35V		TEESVA1V105M8R	K78160032		1-	A	D6
C 1556	CHIP CAP.	330pF	50V	CH	GRM1882C1H331JA01D	K22174253		1-	A	C6
C 1557	CHIP CAP.	0.001uF	50V	B	GRM188B11H102KA01D	K22174821		1-	A	E2
C 1558	CHIP CAP.	0.1uF	16V	B	GRM188B11C104KA01D	K22124805		1-	A	E2
C 1559	CHIP CAP.	0.1uF	16V	B	GRM188B11C104KA01D	K22124805		1-	A	E5
C 1560	AL.ELECTRO.CAP.	47uF	16V		EEE1CA470WR	K48120025		1-	A	A5
C 1561	CHIP CAP.	0.1uF	16V	B	GRM188B11C104KA01D	K22124805		1-	A	F5
C 1562	AL.ELECTRO.CAP.	220uF	10V		RV3-10V221MF80-R	K48100002		1-	A	A5
C 1563	CHIP CAP.	0.01uF	50V	B	GRM188B11H103KA01D	K22174823		1-	A	D6
C 1564	CHIP CAP.	0.01uF	50V	B	GRM188B11H103KA01D	K22174823		1-	A	E3
C 1565	CHIP CAP.	0.01uF	50V	B	GRM188B11H103KA01D	K22174823		1-	A	F3
C 1566	CHIP CAP.	0.01uF	50V	B	GRM188B11H103KA01D	K22174823		1-	A	F3
C 1567	CHIP CAP.	6pF	50V	CH	GRM1882C1H6R0DZ01D	K22174207		1-	A	E4
C 1568	CHIP CAP.	0.01uF	50V	B	GRM188B11H103KA01D	K22174823		1-	A	D6
C 1569	CHIP TA.CAP.	10uF	16V		TEESVA1C106M8R	K78120077		1-	A	E4
C 1570	CHIP CAP.	0.001uF	50V	B	GRM188B11H102KA01D	K22174821		1-	A	E4
C 1571	CHIP CAP.	0.001uF	50V	B	GRM188B11H102KA01D	K22174821		1-	A	A5
C 1572	CHIP CAP.	0.01uF	50V	B	GRM188B11H103KA01D	K22174823		1-	A	F5
C 1573	CHIP TA.CAP.	1uF	35V		TEESVA1V105M8R	K78160032		1-	A	D6
C 1574	CHIP CAP.	0.001uF	50V	B	GRM188B11H102KA01D	K22174821		1-	A	E1
C 1575	CHIP CAP.	0.1uF	16V	B	GRM188B11C104KA01D	K22124805		1-	A	E4
C 1576	CHIP CAP.	0.01uF	50V	B	GRM188B11H103KA01D	K22174823		1-	A	D6
C 1577	CHIP CAP.	0.1uF	16V	B	GRM188B11C104KA01D	K22124805		1-	A	E5
C 1578	CHIP CAP.	100pF	50V	CH	GRM1882C1H101JA01D	K22174235		1-	A	F5
C 1579	CHIP CAP.	0.001uF	50V	B	GRM188B11H102KA01D	K22174821		1-	A	E1
C 1580	CHIP CAP.	0.1uF	16V	B	GRM188B11C104KA01D	K22124805		1-	A	C4

MAIN Unit

Parts List

REF	DESCRIPTION	VALUE	V/W	TOL.	MFR'S DESIG	VXSTD P/N	VERS.	LOT	SIDE	LAY ADR
C 1581	CHIP CAP.	82pF	50V	CH	GRM1882C1H820JA01D	K22174233		1-	A	E3
C 1581	CHIP CAP.	56pF	50V	CH	GRM1882C1H560JA01D	K22174229		13-	A	E3
C 1582	CHIP CAP.	91pF	50V	CH	GRM1882C1H910JZ01D	K22174234		1-	A	F3
C 1583	CHIP CAP.	91pF	50V	CH	GRM1882C1H910JZ01D	K22174234		1-	A	F3
C 1584	CHIP CAP.	0.01uF	50V	B	GRM188B11H103KA01D	K22174823		1-	A	E2
C 1585	CHIP TA.CAP.	10uF	16V		TEESVA1C106M8R	K78120077		1-	A	E5
C 1586	CHIP CAP.	0.01uF	50V	B	GRM188B11H103KA01D	K22174823		1-	A	A5
C 1587	CHIP CAP.	6pF	50V	CH	GRM1882C1H6R0DZ01D	K22174207		13-	A	E3
C 1590	CHIP CAP.	0.1uF	16V	B	GRM188B11C104KA01D	K22124805		1-	A	G1
C 1591	CHIP TA.CAP.	10uF	16V		TEESVA1C106M8R	K78120077		1-	A	G1
C 1592	CHIP TA.CAP.	10uF	16V		TEESVA1C106M8R	K78120077		1-	A	E2
C 1593	CHIP CAP.	0.1uF	16V	B	GRM188B11C104KA01D	K22124805		1-	A	F5
C 1594	CHIP CAP.	180pF	50V	CH	GRM1882C1H181JA01D	K22174241		1-	A	C4
C 1595	CHIP CAP.	82pF	50V	CH	GRM1882C1H820JA01D	K22174233		1-	A	E5
C 1596	CHIP CAP.	0.001uF	50V	B	GRM188B11H102KA01D	K22174821		1-	A	E1
C 1597	CHIP CAP.	0.001uF	50V	B	GRM188B11H102KA01D	K22174821		1-	A	E5
C 1598	CHIP CAP.	0.1uF	16V	B	GRM188B11C104KA01D	K22124805		1-	A	B2
C 1599	CHIP CAP.	82pF	50V	CH	GRM1882C1H820JA01D	K22174233		1-	A	F5
C 1600	CHIP TA.CAP.	10uF	16V		TEESVA1C106M8R	K78120077		1-	A	E4
C 1601	CHIP CAP.	0.047uF	25V	B	GRM188B11E473KA01D	K22144811		1-	A	A5
C 1603	CHIP CAP.	15pF	50V	CH	GRM1882C1H150JA01D	K22174215		1-	A	E3
C 1605	CHIP CAP.	43pF	50V	CH	GRM1882C1H430JZ01D	K22174226		1-	A	F3
C 1607	CHIP CAP.	43pF	50V	CH	GRM1882C1H430JZ01D	K22174226		1-	A	F3
C 1608	CHIP TA.CAP.	1uF	35V		TEESVA1V105M8R	K78160032		1-	A	A5
C 1610	CHIP CAP.	0.01uF	50V	B	GRM188B11H103KA01D	K22174823		1-	A	E6
C 1611	CHIP TA.CAP.	10uF	16V		TEESVA1C106M8R	K78120077		1-	A	C4
C 1612	AL.ELECTRO.CAP.	1000uF	16V		RE3-16V102MH3#-T2	K46120013		1-	A	A4
C 1613	CHIP CAP.	0.001uF	50V	B	GRM188B11H102KA01D	K22174821		1-	A	A5
C 1614	CHIP CAP.	0.1uF	16V	B	GRM188B11C104KA01D	K22124805		1-	A	C4
C 1615	CHIP CAP.	0.1uF	16V	B	GRM188B11C104KA01D	K22124805		1-	A	F5
C 1616	CHIP CAP.	0.1uF	16V	B	GRM188B11C104KA01D	K22124805		1-	A	D5
C 1617	CHIP CAP.	0.1uF	16V	B	GRM188B11C104KA01D	K22124805		1-	A	E5
C 1618	CHIP CAP.	0.01uF	50V	B	GRM188B11H103KA01D	K22174823		1-	A	A5
C 1619	CHIP CAP.	0.1uF	16V	B	GRM188B11C104KA01D	K22124805		1-	A	E5
C 1620	CHIP CAP.	0.01uF	50V	B	GRM188B11H103KA01D	K22174823		1-	A	E6
C 1621	CHIP CAP.	0.01uF	50V	B	GRM188B11H103KA01D	K22174823		1-	A	G4
C 1622	CHIP CAP.	0.01uF	50V	B	GRM188B11H103KA01D	K22174823		1-	A	E1
C 1623	CHIP CAP.	0.01uF	50V	B	GRM188B11H103KA01D	K22174823		1-	A	F5
C 1624	CHIP CAP.	0.01uF	50V	B	GRM188B11H103KA01D	K22174823		1-	A	B2
C 1625	CHIP CAP.	0.01uF	50V	B	GRM188B11H103KA01D	K22174823		1-	A	C4
C 1626	CHIP CAP.	0.1uF	16V	B	GRM188B11C104KA01D	K22124805		1-	A	E5
C 1627	CHIP CAP.	0.01uF	50V	B	GRM188B11H103KA01D	K22174823		1-	A	F3
C 1628	CHIP CAP.	100pF	50V	CH	GRM1882C1H101JA01D	K22174235		1-	A	F5
C 1629	CHIP TA.CAP.	1.1uF	35V		TEESVA1V104M8R	K78160025		1-	A	E1
C 1630	CHIP TA.CAP.	10uF	16V		TEESVA1C106M8R	K78120077		1-	A	G4
C 1631	CHIP CAP.	0.01uF	50V	B	GRM188B11H103KA01D	K22174823		1-	A	F3
C 1632	CHIP CAP.	0.01uF	50V	B	GRM188B11H103KA01D	K22174823		1-	A	F3
C 1633	CHIP CAP.	100pF	50V	CH	GRM1882C1H101JA01D	K22174235		1-	A	F5
C 1634	CHIP TA.CAP.	10uF	16V		TEESVA1C106M8R	K78120077		1-	A	F5
C 1635	CHIP CAP.	0.01uF	50V	B	GRM188B11H103KA01D	K22174823		1-	A	F5
C 1636	CHIP CAP.	0.0022uF	50V	B	GRM188B11H222KA01D	K22174813		1-	A	C5
C 1637	AL.ELECTRO.CAP.	1000uF	16V		RE3-16V102MH3#-T2	K46120013		1-	A	A4
C 1638	AL.ELECTRO.CAP.	470uF	16V		RE3-16V471MG3#-T2	K46120014		1-	A	A5
C 1639	CHIP CAP.	0.1uF	16V	B	GRM188B11C104KA01D	K22124805		1-	A	D5
C 1644	CHIP CAP.	0.015uF	50V	B	GRM188B11H153KA01D	K22174838		1-	A	C5
C 1645	CHIP CAP.	0.01uF	50V	B	GRM188B11H103KA01D	K22174823		1-	A	F5
C 1646	CHIP CAP.	68pF	50V	CH	GRM1882C1H680JA01D	K22174231		1-	A	E4
C 1646	CHIP CAP.	47pF	50V	CH	GRM1882C1H470JA01D	K22174227		13-	A	E4
C 1647	CHIP CAP.	82pF	50V	CH	GRM1882C1H820JA01D	K22174233		1-	A	F4
C 1648	CHIP CAP.	82pF	50V	CH	GRM1882C1H820JA01D	K22174233		1-	A	F4
C 1649	CHIP CAP.	0.1uF	16V	B	GRM188B11C104KA01D	K22124805		1-	A	F5
C 1650	CHIP TA.CAP.	10uF	16V		TEESVA1C106M8R	K78120077		1-	A	D5
C 1651	CHIP CAP.	0.1uF	16V	B	GRM188B11C104KA01D	K22124805		1-	A	B5
C 1652	CHIP CAP.	0.01uF	50V	B	GRM188B11H103KA01D	K22174823		1-	A	D6
C 1653	CHIP CAP.	0.01uF	50V	B	GRM188B11H103KA01D	K22174823		1-	A	F5
C 1654	CHIP CAP.	0.1uF	16V	B	GRM188B11C104KA01D	K22124805		1-	A	D5
C 1655	CHIP CAP.	0.0015uF	50V	B	GRM188B11H152KA01D	K22174827		1-	A	D5
C 1656	CHIP CAP.	0.01uF	50V	B	GRM188B11H103KA01D	K22174823		1-	A	E4
C 1657	CHIP CAP.	0.01uF	50V	B	GRM188B11H103KA01D	K22174823		1-	A	F4
C 1658	CHIP CAP.	0.01uF	50V	B	GRM188B11H103KA01D	K22174823		1-	A	F4
C 1659	CHIP CAP.	0.01uF	50V	B	GRM188B11H103KA01D	K22174823		1-	A	F5
C 1660	CHIP CAP.	0.01uF	50V	B	GRM188B11H103KA01D	K22174823		1-	A	F5
C 1661	CHIP CAP.	5pF	50V	CH	GRM1882C1H5R0CZ01D	K22174206		1-	A	F5

MAIN Unit

Parts List

REF	DESCRIPTION	VALUE	V/W	TOL.	MFR'S DESIG	VXSTD P/N	VERS.	LOT	SIDE	LAY ADR
C 1662	CHIP CAP.	0.0056uF	50V	B	GRM188B11H562KA01D	K22174818		1-	A	C5
C 1664	CHIP CAP.	0.01uF	50V	B	GRM188B11H103KA01D	K22174823		1-	A	F5
C 1665	CHIP CAP.	0.01uF	50V	B	GRM188B11H103KA01D	K22174823		1-	A	D5
C 1666	CHIP TA.CAP.	10uF	16V		TEESVA1C106M8R	K78120077		1-	A	C5
C 1668	CHIP CAP.	0.1uF	16V	B	GRM188B11C104KA01D	K22124805		1-	A	A5
C 1669	CHIP CAP.	0.1uF	16V	B	GRM188B11C104KA01D	K22124805		1-	A	C5
C 1672	CHIP CAP.	0.01uF	50V	B	GRM188B11H103KA01D	K22174823		1-	A	D5
C 1673	CHIP TA.CAP.	10uF	16V		TEESVA1C106M8R	K78120077		1-	A	D5
C 1674	CHIP CAP.	0.1uF	16V	B	GRM188B11C104KA01D	K22124805		1-	A	G5
C 1676	CHIP CAP.	0.01uF	50V	B	GRM188B11H103KA01D	K22174823		1-	A	F4
C 1679	CHIP CAP.	0.001uF	50V	B	GRM188B11H102KA01D	K22174821		1-	A	F4
C 1680	CHIP CAP.	0.01uF	50V	B	GRM188B11H103KA01D	K22174823		1-	A	B6
C 1682	CHIP CAP.	0.001uF	50V	B	GRM188B11H102KA01D	K22174821		1-	A	F4
C 1683	CHIP TA.CAP.	1uF	35V		TEESVA1V105M8R	K78160032		1-	A	C5
C 1684	CHIP CAP.	0.01uF	50V	B	GRM188B11H103KA01D	K22174823		1-	A	A6
C 1685	CHIP TA.CAP.	10uF	16V		TEESVA1C106M8R	K78120077		1-	A	D4
C 1686	CHIP CAP.	0.01uF	50V	B	GRM188B11H103KA01D	K22174823		1-	A	A6
C 1689	CHIP TA.CAP.	10uF	16V		TEESVA1C106M8R	K78120077		1-	A	C5
C 1690	CHIP CAP.	0.022uF	50V	B	GRM188B11H223KA01D	K22174839		1-	A	A5
C 1691	CHIP CAP.	68pF	50V	CH	GRM1882C1H680JA01D	K22174231		1-	A	F4
C 1693	CHIP CAP.	0.1uF	16V	B	GRM188B11C104KA01D	K22124805		1-	A	D4
C 1694	CHIP CAP.	0.01uF	50V	B	GRM188B11H103KA01D	K22174823		1-	A	F5
C 1695	CHIP TA.CAP.	1uF	35V		TEESVA1V105M8R	K78160032		1-	A	B6
C 1696	CHIP CAP.	0.01uF	50V	B	GRM188B11H103KA01D	K22174823		1-	A	B5
C 1697	CHIP CAP.	0.022uF	50V	B	GRM188B11H223KA01D	K22174839		1-	A	A5
C 1698	CHIP CAP.	0.01uF	50V	B	GRM188B11H103KA01D	K22174823		1-	A	D5
C 1701	CHIP CAP.	470pF	50V	CH	GRM1882C1H471JA01D	K22174249		1-	A	F5
C 1702	CHIP CAP.	0.1uF	16V	B	GRM188B11C104KA01D	K22124805		1-	A	B6
C 1703	CHIP CAP.	0.022uF	50V	B	GRM188B11H223KA01D	K22174839		1-	A	A5
C 1704	CHIP CAP.	0.01uF	50V	B	GRM188B11H103JA01D	K22174824		1-	A	F5
C 1705	CHIP CAP.	0.01uF	50V	B	GRM188B11H103KA01D	K22174823		1-	A	F5
C 1706	CHIP CAP.	15pF	50V	CH	GRM1882C1H150JA01D	K22174215		1-	A	F5
C 1707	CHIP CAP.	0.0033uF	50V	B	GRM188B11H332KA01D	K22174815		1-	A	C5
C 1709	CHIP TA.CAP.	0.068uF	35V		TEESVA1V683M8R	K78160024		1-	A	C5
C 1710	CHIP CAP.	0.01uF	50V	B	GRM188B11H103KA01D	K22174823		1-	A	B6
C 1712	CHIP CAP.	0.022uF	50V	B	GRM188B11H223KA01D	K22174839		1-	A	A5
C 1713	CHIP CAP.	0.01uF	50V	B	GRM188B11H103KA01D	K22174823		1-	A	F5
C 1714	CHIP CAP.	0.047uF	25V	B	GRM188B11E473KA01D	K22144811		1-	A	C5
C 1715	CHIP CAP.	0.022uF	50V	B	GRM188B11H223KA01D	K22174839		1-	A	A5
C 1716	CHIP CAP.	0.01uF	50V	B	GRM188B11H103KA01D	K22174823		1-	A	E3
C 1717	CHIP CAP.	0.01uF	50V	B	GRM188B11H103JA01D	K22174824		1-	A	F5
C 1718	CHIP CAP.	0.01uF	50V	B	GRM188B11H103KA01D	K22174823		1-	A	F5
C 1720	CHIP TA.CAP.	0.47uF	25V		TEESVA1E474M8R	K78140009		1-8	A	F4
C 1720	CHIP TA.CAP.	0.33uF	35V		TEESVA1V334M8R	K78160028		12-	A	F4
C 1721	CHIP CAP.	82pF	50V	CH	GRM1882C1H820JA01D	K22174233		1-	A	H4
C 1722	CHIP CAP.	47pF	50V	CH	GRM1882C1H470JA01D	K22174227		1-	A	G4
C 1723	CHIP CAP.	82pF	50V	CH	GRM1882C1H820JA01D	K22174233		1-	A	G4
C 1729	TANTALUM CAP.	4.7uF	25V		TPDN1E4R7M8S(MX0)	K76140017		9-		
C 1729	TANTALUM CAP.	4.7uF	35V		DN1V4R7M1S	K70167475		9-		
C 1730	CHIP CAP.	10pF	50V	CH	GRM1882C1H100JA01D	K22174211		33-		
C 1731	CHIP CAP.	10pF	50V	CH	GRM1882C1H100JA01D	K22174211		33-		
CF1001	CERAMIC FILTER				CFWLB450KE2A-B0	H3900466		1-	A	E5
CF1001	CERAMIC FILTER				ALFYM450F-002S2=K	H3900556		16-	A	E5
CF1001	CERAMIC FILTER				CFWLB450KFFA-B0	H3900582		19-	A	E5
CF1002	CERAMIC FILTER				CFWLB450KE1Y-B0	H3900568		1-	A	D5
D 1001	SURGE ABSORBER				TVSF0603	Q9000847		1-	A	H6
D 1001	SURGE ABSORBER				1608SGX	Q9000891		13-	A	H6
D 1003	DIODE				BAS316	G2070716		1-	A	A2
D 1004	DIODE				BAS316	G2070716		1-	A	H5
D 1005	DIODE				MC2848-T111-1	G2070694		1-	A	E6
D 1005	DIODE				DAN202U T106	G2070162		9-	A	E6
D 1006	DIODE				1SR154-400 TE25	G2070684		1-	A	E6
D 1007	DIODE				BAS316	G2070716		1-	A	B1
D 1008	DIODE				BAS316	G2070716		1-	A	H5
D 1009	DIODE				RN142S TE61	G2070994		1-	A	C1
D 1010	DIODE				RN142S TE61	G2070994		1-	A	C1
D 1011	DIODE				RN142S TE61	G2070994		1-	A	C1
D 1012	DIODE				RN142S TE61	G2070994		1-	A	H4
D 1013	DIODE				RN142S TE61	G2070994		1-	A	H4
D 1014	DIODE				RN142S TE61	G2070994		1-	A	H3
D 1015	DIODE				RN142S TE61	G2070994		1-	A	H3
D 1016	DIODE				BAS316	G2070716		1-	A	G5
D 1017	DIODE				BAS316	G2070716		1-	A	A3

MAIN Unit

Parts List

REF	DESCRIPTION	VALUE	V/W	TOL.	MFR'S DESIG	VXSTD P/N	VERS.	LOT	SIDE	LAY ADR
D 1018	DIODE				RN142S TE61	G2070994		1-	A	G4
D 1019	DIODE				RN142S TE61	G2070994		1-	A	G4
D 1020	DIODE				RN142S TE61	G2070994		1-	A	G3
D 1021	DIODE				RN142S TE61	G2070994		1-	A	G3
D 1022	DIODE				RN142S TE61	G2070994		1-	A	D2
D 1023	DIODE				RN142S TE61	G2070994		1-	A	D2
D 1024	DIODE				RN142S TE61	G2070994		1-	A	D2
D 1025	DIODE				RN142S TE61	G2070994		1-	A	H3
D 1026	DIODE				RN142S TE61	G2070994		1-	A	H2
D 1027	DIODE				RN142S TE61	G2070994		1-	A	H2
D 1028	DIODE				BAS316	G2070716		1-	A	H5
D 1029	DIODE				BAS316	G2070716		1-	A	B2
D 1030	DIODE				HZM7.5NB3-TL-E	G2070786		1-	A	D4
D 1031	DIODE				HSB88WS TR-E	G2070290		1-	A	D2
D 1032	DIODE				RN142S TE61	G2070994		1-	A	G3
D 1033	DIODE				RN142S TE61	G2070994		1-	A	G2
D 1034	DIODE				RN142S TE61	G2070994		1-	A	G2
D 1035	DIODE				HZM7.5NB3-TL-E	G2070786		1-	A	D4
D 1036	DIODE				HSC277TRF-E	G2070584		1-	A	E3
D 1037	DIODE				JDP2S04E(TAPE)	G2071180		1-	A	D3
D 1038	DIODE				HZM7.5NB3-TL-E	G2070786		1-	A	D4
D 1039	DIODE				BAS316	G2070716		1-	A	C3
D 1040	DIODE				BAS316	G2070716		1-	A	F1
D 1041	DIODE				BAS316	G2070716		1-	A	C3
D 1042	DIODE				MC2848-T111-1	G2070694		1-	A	D4
D 1042	DIODE				DAN202U T106	G2070162		9-	A	D4
D 1043	DIODE				MC2848-T111-1	G2070694		1-	A	D4
D 1043	DIODE				DAN202U T106	G2070162		9-	A	D4
D 1044	DIODE				BAS316	G2070716		1-	A	C3
D 1045	DIODE				RN142S TE61	G2070994		1-	A	F2
D 1046	DIODE				RN142S TE61	G2070994		1-	A	F2
D 1047	DIODE				BAS316	G2070716		1-	A	F1
D 1048	DIODE				BAS316	G2070716		1-	A	E5
D 1050	DIODE				MC2848-T111-1	G2070694		1-	A	E5
D 1050	DIODE				DAN202U T106	G2070162		9-	A	E5
D 1051	DIODE				DAP236U T106	G2070592		1-	A	D3
D 1052	DIODE				BAS316	G2070716		1-	A	E6
D 1053	DIODE				HSM198S TR-E	G2070570		1-	A	E2
D 1054	DIODE				1SS226(TE85R.F)	G2070003		1-	A	E3
D 1055	DIODE				HSB88WS TR-E	G2070290		1-	A	D5
D 1056	DIODE				1SS372(TE85R.F)	G2070632		1-	A	E6
D 1057	DIODE				HSC277TRF-E	G2070584		1-	A	E3
D 1058	DIODE				DAP236U T106	G2070592		1-	A	E4
D 1059	DIODE				MC2848-T111-1	G2070694		1-	A	C5
D 1059	DIODE				DAN202U T106	G2070162		9-	A	C5
D 1060	DIODE				RN142S TE61	G2070994		1-	A	F3
D 1061	DIODE				RN142S TE61	G2070994		1-	A	F3
D 1062	DIODE				RN142S TE61	G2070994		1-	A	F3
D 1064	DIODE				JDP2S04E(TAPE)	G2071180		1-	A	E1
D 1065	DIODE				JDP2S04E(TAPE)	G2071180		1-	A	E1
D 1066	DIODE				BAS316	G2070716		1-	A	E5
D 1067	DIODE				MC2850-T111-1	G2070704		1-	A	B5
D 1067	DIODE				DAN217U T106	G2071236		9-	A	B5
D 1068	DIODE				JDP2S04E(TAPE)	G2071180		1-	A	E1
D 1069	DIODE				BAS316	G2070716		1-	A	E6
D 1070	DIODE				BAS316	G2070716		1-	A	A5
D 1071	DIODE				BAS316	G2070716		1-	A	D6
D 1072	DIODE				BAS316	G2070716		1-	A	A5
D 1073	DIODE				RN142S TE61	G2070994		1-	A	F4
D 1074	DIODE				RN142S TE61	G2070994		1-	A	F4
D 1075	DIODE				RN142S TE61	G2070994		1-	A	F4
D 1077	DIODE				BAS316	G2070716		1-	A	A6
D 1078	DIODE				JDP2S04E(TAPE)	G2071180		1-	A	F5
FB1001	FERRITE BEADS				BLM18BD182SN1D	L1690602		1-	A	A2
FB1002	FERRITE BEADS				BLM18BD182SN1D	L1690602		1-	A	A2
FB1003	FERRITE BEADS				BLM18BD182SN1D	L1690602		1-	A	A2
FB1004	FERRITE BEADS				BLM18BD182SN1D	L1690602		1-	A	A2
FB1005	FERRITE BEADS				BLM18BD182SN1D	L1690602		1-	A	A2
FB1006	FERRITE BEADS				BLM18BD182SN1D	L1690602		1-	A	A2
FB1007	FERRITE BEADS				BLM18BD182SN1D	L1690602		1-	A	A2
FB1008	FERRITE BEADS				BLM18BD182SN1D	L1690602		1-	A	A2
FB1009	FERRITE BEADS				BLM18BD182SN1D	L1690602		1-	A	A2
FB1010	FERRITE BEADS				BLM18BD182SN1D	L1690602		1-	A	A2

MAIN Unit

Parts List

REF	DESCRIPTION	VALUE	V/W	TOL.	MFR'S DESIG	VXSTD P/N	VERS.	LOT	SIDE	LAY ADR
FB1011	FERRITE BEADS				BLM18BD182SN1D	L1690602		1-	A	A2
FB1014	FERRITE BEADS				BLM18BD182SN1D	L1690602		1-	A	A2
FB1015	FERRITE BEADS				BLM18BD182SN1D	L1690602		1-	A	A3
FB1016	FERRITE BEADS				BLM18BD182SN1D	L1690602		1-	A	A3
FB1017	FERRITE BEADS				BLM18BD182SN1D	L1690602		1-	A	C3
FB1018	FERRITE BEADS				BLM18BD182SN1D	L1690602		1-	A	C3
J 1001	CONNECTOR				JPJ2545-01-510	P1090633		1-	A	G6
J 1002	CONNECTOR				JPJ2545-01-510	P1090633		1-	A	H6
J 1003	CONNECTOR				JPJ2545-01-510	P1090633		1-	A	C6
J 1004	CONNECTOR				18FLT-SM2-TB(LF)(SN)(M)	P1091176		1-	A	A1
J 1005	CONNECTOR				SB20-14WS	P0090656		1-	A	H1
J 1006	CONNECTOR				YKB21-5296N	P1091233		1-	A	C6
J 1007	CONNECTOR				TMP-J01X-V6	P1090210		1-	A	H6
J 1008	CONNECTOR				30FLT-SM2-TB(LF)(SN)(M)	P1091142		1-	A	A2
J 1009	CONNECTOR				M50-008-020 R41-9553F	P1091132		1-	A	E6
J 1010	CONNECTOR				TCS7705-5120177	P1091244		1-	A	F6
J 1011	CONNECTOR				TMP-J01X-V6	P1090210		1-	A	A1
J 1012	CONNECTOR				M50006020-IIBA R41-9553D	P1090925		1-	A	F6
J 1013	CONNECTOR				30FLT-SM2-TB(LF)(SN)(M)	P1091142		1-	A	A3
J 1014	CONNECTOR				SC25-03WS	P0090622		1-	A	D4
J 1015	CONNECTOR				IMSA-6065B-06-Z049-PT1	P0091383		1-		
J 1016	CONNECTOR				IMSA-6065B-05-Z049-PT1	P0091382		1-		
J 1017	CONNECTOR				SB20-02WS	P0090609		1-	A	C3
J 1018	CONNECTOR				SB20-04WS	P0090611		1-	A	C4
J 1019	CONNECTOR				M50006020-IIBA R41-9553D	P1090925		1-	A	D6
J 1020	CONNECTOR				JPJ2545-01-510	P1090633		1-	A	D6
J 1021	CONNECTOR				SB20-08WS	P0090615		1-	A	C5
J 1022	CONNECTOR				SC25-02WS	P0090621		1-	A	B6
J 1023	CONNECTOR				SB20-03WS	P0090610		1-	A	A6
J 1024	CONNECTOR				SB20-06WS	P0090613		1-	A	A5
J 1025	CONNECTOR				TMP-J01X-V6	P1090210		1-	A	E1
J 1026	CONNECTOR				TMP-J01X-V6	P1090210		1-	A	F4
J 1027	CONNECTOR				TMP-J01X-V6	P1090210		1-	A	C4
J 1028	CONNECTOR				TMP-J01X-V6	P1090210		1-	A	E3
J 1029	CONNECTOR				TMP-J01X-V6	P1090210		1-	A	H1
J 1030	CONNECTOR				YKB21-5296N	P1091233		1-	A	B6
J 1031	CONNECTOR				HLJ2305-0130609	P1090823		1-	A	A6
JP1001	WIRE ASSY				GRN 40 2/2	T50504000		1-		
JP1001	WIRE AWG40-0.21PFA				GRN 40(2)/(2)	T9318338		41-		
JP1002	WIRE ASSY				GRN 40 2/2	T50504000		1-		
JP1002	WIRE AWG40-0.21PFA				GRN 40(2)/(2)	T9318338		41-		
L 1001	M.RFC	1000uH			LLM3225-102J	L1691157		1-	A	C6
L 1002	M.RFC	1000uH			LLM3225-102J	L1691157		1-	A	C6
L 1003	M.RFC	1mH			LAV35VB102J	L1790255		1-	A	H6
L 1004	M.RFC	100uH			LLM3225-101J	L1691145		1-	A	F6
L 1005	M.RFC	100uH			LLM3225-101J	L1691145		1-	A	E6
L 1007	CHIP COIL	0.1uH		2%	C2520C-R10G	L1691294		1-	A	B1
L 1008	CHIP COIL	0.15uH		2%	C2520C-R15G	L1691296		1-	A	B1
L 1009	CHIP COIL	0.15uH		2%	C2520C-R15G	L1691296		1-	A	B1
L 1010	M.RFC	100uH			LLM3225-101J	L1691145		1-	A	F6
L 1011	M.RFC	10uH			LLM3225-100J	L1691133		1-	A	B1
L 1012	M.RFC	1mH			LAV35VB102J	L1790255		1-	A	H4
L 1013	M.RFC	6.8uH			LAP02TA6R8K	L1790056		1-	A	C1
L 1014	M.RFC	0.27uH			LAP02TAR27K	L1790039		1-	A	C2
L 1015	CHIP COIL	0.047uH		2%	C2520C-47NG	L1691290		1-	A	C2
L 1016	CHIP COIL	1uH		2%	C2520C-1R0G	L1691309		1-	A	H4
L 1017	M.RFC	0.39uH			LAP02TAR39K	L1790041		1-	A	H3
L 1018	M.RFC	0.56uH			LAP02TAR56K	L1790043		1-	A	H3
L 1019	M.RFC	0.56uH			LAV35VBR56M	L1790216		1-	A	H3
L 1020	M.RFC	0.56uH			LAP02TAR56K	L1790043		1-	A	C1
L 1021	M.RFC	0.39uH			LAP02TAR39K	L1790041		1-	A	C1
L 1022	M.RFC	0.68uH			LAP02TAR68K	L1790044		1-	A	D2
L 1024	M.RFC	0.39uH			LAP02TAR39K	L1790041		1-	A	H4
L 1025	M.RFC	0.82uH			LAP02TAR82K	L1790045		1-	A	H3
L 1026	M.RFC	1.8uH			LAV35VB1R8K	L1790222		1-	A	H3
L 1027	M.RFC	3.3uH			LAP02TA3R3K	L1790052		1-	A	D1
L 1028	M.RFC	0.15uH			LAN02TAR15K	L1790168		1-	A	D1
L 1029	CHIP COIL	0.027uH		2%	C2520C-27NG	L1691287		1-	A	D2
L 1030	M.RFC	0.18uH			LAN02TAR18K	L1790169		1-	A	G5
L 1032	CHIP COIL	0.12uH			C2520C-R12J	L1690545		1-	A	H4
L 1033	M.RFC	0.18uH			LAN02TAR18K	L1790169		1-	A	H3
L 1034	M.RFC	0.22uH			LAV35VBR22M	L1790211		1-	A	H3
L 1035	M.RFC	0.56uH			LAP02TAR56K	L1790043		1-	A	D1

MAIN Unit

Parts List

REF	DESCRIPTION	VALUE	V/W	TOL.	MFR'S DESIG	VXSTD P/N	VERS.	LOT	SIDE	LAY ADR
L 1036	M.RFC	0.39uH			LAP02TAR39K	L1790041		1-	A	D1
L 1037	M.RFC	0.68uH			LAP02TAR68K	L1790044		1-	A	D2
L 1039	M.RFC	0.39uH			LAP02TAR39K	L1790041		1-	A	G4
L 1040	M.RFC	0.82uH			LAP02TAR82K	L1790045		1-	A	G3
L 1041	M.RFC	1.8uH			LAV35VB1R8K	L1790222		1-	A	G3
L 1042	M.RFC	4.7uH			LAV35VB4R7K	L1790227		1-	A	H4
L 1043	M.RFC	0.22uH			LAN02TAR22K	L1790170		1-	A	G5
L 1044	M.RFC	3.9uH			LAV35VB3R9K	L1790226		1-	A	H4
L 1045	M.RFC	0.18uH			LAN02TAR18K	L1790169		1-	A	H5
L 1046	M.RFC	3.9uH			LAV35VB3R9K	L1790226		1-	A	H5
L 1047	CHIP COIL	1uH		2%	C2520C-1R0G	L1691309		1-	A	G4
L 1048	M.RFC	0.39uH			LAP02TAR39K	L1790041		1-	A	G3
L 1049	M.RFC	0.56uH			LAP02TAR56K	L1790043		1-	A	G3
L 1050	M.RFC	0.56uH			LAV35VBR56M	L1790216		1-	A	G3
L 1051	M.RFC	6.8uH			LAP02TA6R8K	L1790056		1-	A	D1
L 1052	M.RFC	0.27uH			LAP02TAR27K	L1790039		1-	A	D2
L 1053	CHIP COIL	0.047uH		2%	C2520C-47NG	L1691290		1-	A	D2
L 1054	M.RFC	4.7uH			LAV35VB4R7K	L1790227		1-	A	H5
L 1055	M.RFC	1.5uH			LAV35VB1R5K	L1790221		1-	A	H2
L 1056	M.RFC	1.8uH			LAV35VB1R8K	L1790222		1-	A	H2
L 1057	M.RFC	5.6uH			LAV35VB5R6K	L1790228		1-	A	H2
L 1058	M.RFC	1.8uH			LAV35VB1R8K	L1790222		1-	A	H2
L 1059	M.RFC	5.6uH			LAV35VB5R6K	L1790228		1-	A	H2
L 1060	M.RFC	5.6uH			LAV35VB5R6K	L1790228		1-	A	H2
L 1061	M.RFC	6.8uH			LAV35VB6R8K	L1790229		1-	A	H5
L 1062	M.RFC	0.56uH			LAV35VBR56M	L1790216		1-	A	H2
L 1063	M.RFC	0.56uH			LAV35VBR56M	L1790216		1-	A	H2
L 1064	M.RFC	1.8uH			LAV35VB1R8K	L1790222		1-	A	H2
L 1066	M.RFC	1.8uH			LAV35VB1R8K	L1790222		1-	A	G2
L 1067	M.RFC	5.6uH			LAV35VB5R6K	L1790228		1-	A	G2
L 1068	M.RFC	5.6uH			LAV35VB5R6K	L1790228		1-	A	G2
L 1069	M.RFC	6.8uH			LAV35VB6R8K	L1790229		1-	A	G5
L 1070	M.RFC	220uH			LAV35VB221J	L1790247		1-	A	G5
L 1071	CHIP COIL	0.15uH		2%	C2520C-R15G	L1691296		1-	A	D3
L 1072	M.RFC	1uH			LK1608 1R0K-T	L1690687		1-	A	D3
L 1073	M.RFC	1.5uH			LAV35VB1R5K	L1790221		1-	A	G2
L 1074	M.RFC	1.8uH			LAV35VB1R8K	L1790222		1-	A	G2
L 1075	M.RFC	5.6uH			LAV35VB5R6K	L1790228		1-	A	G2
L 1076	M.RFC	1mH			LAV35VB102J	L1790255		1-	A	G4
L 1077	M.RFC	1mH			LAV35VB102J	L1790255		1-	A	F2
L 1078	CHIP COIL	0.15uH		2%	C2520C-R15G	L1691296		1-	A	D3
L 1079	M.RFC	47uH			LLM3225-470J	L1691141		1-	A	F1
L 1080	CHIP COIL	2.2uH		2%	C2520C-2R2G	L1691313		1-	A	E3
L 1081	M.RFC	47uH			LLM3225-470J	L1691141		1-	A	F1
L 1083	M.RFC	1mH			LAV35VB102J	L1790255		1-	A	F2
L 1084	CHIP COIL	0.1uH		2%	C2520C-R10G	L1691294		1-	A	E3
L 1085	CHIP COIL	0.1uH		2%	C2520C-R10G	L1691294		1-	A	E2
L 1086	CHIP COIL	0.15uH		2%	C2520C-R15G	L1691296		1-	A	E2
L 1087	M.RFC	1mH			LAV35VB102J	L1790255		1-	A	D5
L 1088	CHIP COIL	0.1uH		2%	C2520C-R10G	L1691294		1-	A	E2
L 1089	CHIP COIL	0.1uH		2%	C2520C-R10G	L1691294		1-	A	E2
L 1092	M.RFC	120uH			RCH-875 121K	L1190396		1-	A	F2
L 1093	M.RFC	0.33uH			LK1608 R33K-T	L1690412		1-	A	E2
L 1094	CHIP COIL	2.2uH		2%	C2520C-2R2G	L1691313		1-	A	F3
L 1095	M.RFC	1mH			LAV35VB102J	L1790255		1-	A	F3
L 1096	CHIP COIL	2.2uH		10%	C2520C-2R2K-RK	L1690731		1-	A	E4
L 1097	M.RFC	470uH			LLM3225-471J	L1691153		1-	A	D6
L 1098	M.RFC	470uH			LLM3225-471J	L1691153		1-	A	D6
L 1099	CHIP COIL	4.7uH		2%	C2520C-4R7G	L1691317		1-	A	E1
L 1100	M.RFC	330uH			LLM3225-331J	L1691151		1-	A	F6
L 1101	M.RFC	470uH			LLM3225-471J	L1691153		1-	A	D6
L 1102	M.RFC	470uH			LLM3225-471J	L1691153		1-	A	E6
L 1103	M.RFC	470uH			LLM3225-471J	L1691153		1-	A	E5
L 1104	M.RFC	470uH			LLM3225-471J	L1691153		1-	A	E6
L 1105	M.RFC	100uH			LLM3225-101J	L1691145		1-	A	F5
L 1106	M.RFC	82uH			LLM3225-820J	L1691144		1-	A	D5
L 1107	M.RFC	470uH			LLM3225-471J	L1691153		1-	A	D6
L 1108	M.RFC	22uH			LAV35VB220K	L1790235		1-	A	F4
L 1109	M.RFC	0.15uH			LAN02TAR15K	L1790168		1-	A	G4
L 1110	M.RFC	0.15uH			LAN02TAR15K	L1790168		1-	A	G4
Q 1001	IC				LM2904PWR	G1094010		1-	A	C1
Q 1002	IC				LM2904PWR	G1094010		1-	A	G6
Q 1003	IC				LM2902PWR	G1094009		1-	A	B2

MAIN Unit

Parts List

REF	DESCRIPTION	VALUE	V/W	TOL.	MFR'S DESIG	VXSTD P/N	VERS.	LOT	SIDE	LAY ADR
Q 1004	IC				NJM2068V-TE1	G1094112		1-	A	D4
Q 1005	IC				NJM2068V-TE1	G1094112		1-	A	D4
Q 1006	IC				LM2904PWR	G1094010		1-	A	C5
Q 1007	IC				LM2904PWR	G1094010		1-	A	C4
Q 1008	IC				NJM2068V-TE1	G1094112		1-	A	D4
Q 1009	IC				NJM2068V-TE1	G1094112		1-	A	D5
Q 1010	IC				NJM2068V-TE1	G1094112		1-	A	D4
Q 1011	IC				LM2902PWR	G1094009		1-	A	C3
Q 1012	IC				LM2904PWR	G1094010		1-	A	E1
Q 1013	IC				LM2902PWR	G1094009		1-	A	C5
Q 1014	IC				LM2904PWR	G1094010		1-	A	A5
Q 1015	IC				LM2904PWR	G1094010		1-	A	C5
Q 1016	IC				LM2904PWR	G1094010		1-	A	G5
Q 1017	TRANSISTOR				DTA114EUA T106	G3070083		1-	A	H5
Q 1018	POLY SWITCH				MINISMDC0505-02	G9090143		1-	A	D6
Q 1019	FET				3SK131-T2B V12	G4801317B		1-	A	C1
Q 1020	IC				BU2152FS(TAPE)	G1093942		1-	A	B3
Q 1021	TRANSISTOR				DTC114YUA T106	G3070298		1-	A	F6
Q 1022	TRANSISTOR				DTC114YUA T106	G3070298		1-	A	F6
Q 1023	TRANSISTOR				2SD2403GY-T1	G3424038Y		1-	A	E6
Q 1024	TRANSISTOR				DTC114EUA T106	G3070084		1-	A	A2
Q 1025	TRANSISTOR				2SC5415E-TD-E	G3354158E		1-	A	B1
Q 1026	TRANSISTOR				DTA114EUA T106	G3070083		1-	A	G5
Q 1027	IC				SN74HCT04PWR	G1094484		1-	A	B3
Q 1028	TRANSISTOR				DTA114EUA T106	G3070083		1-	A	G5
Q 1029	IC				BU2505FV-E2	G1093714		1-	A	C2
Q 1030	TRANSISTOR				DTA114EUA T106	G3070083		1-	A	H5
Q 1031	TRANSISTOR				DTC143ZE TL	G3070102		1-	A	F2
Q 1032	FET				SST310-T1	G4070009		1-	A	E3
Q 1033	TRANSISTOR				2SC4154-T111-1E	G3341548E		1-	A	C5
Q 1033	TRANSISTOR				2SC4081 T106	G3340818		9-	A	C5
Q 1034	TRANSISTOR				2SC3356-T2B R24	G3333567D		1-	A	F1
Q 1035	FET				SST310-T1	G4070009		1-	A	D3
Q 1036	TRANSISTOR				DTC143ZE TL	G3070102		1-	A	D1
Q 1037	TRANSISTOR				DTC143ZE TL	G3070102		1-	A	D1
Q 1038	TRANSISTOR				2SC3356-T2B R24	G3333567D		1-	A	F1
Q 1039	TRANSISTOR				2SC4154-T111-1E	G3341548E		1-	A	D3
Q 1039	TRANSISTOR				2SC4081 T106	G3340818		9-	A	D3
Q 1040	TRANSISTOR				DTC143ZE TL	G3070102		1-	A	D2
Q 1041	TRANSISTOR				2SC4154-T111-1E	G3341548E		1-	A	D5
Q 1041	TRANSISTOR				2SC4081 T106	G3340818		9-	A	D5
Q 1042	TRANSISTOR				DTC143ZE TL	G3070102		1-	A	G6
Q 1043	IC				BB301CAW-TL	G1093186		1-	A	D3
Q 1044	TRANSISTOR				2SC4154-T111-1E	G3341548E		1-	A	C3
Q 1044	TRANSISTOR				2SC4081 T106	G3340818		9-	A	C3
Q 1045	TRANSISTOR				2SC4154-T111-1E	G3341548E		1-	A	D4
Q 1045	TRANSISTOR				2SC4081 T106	G3340818		9-	A	D4
Q 1046	TRANSISTOR				2SC4154-T111-1E	G3341548E		1-	A	D5
Q 1046	TRANSISTOR				2SC4081 T106	G3340818		9-	A	D5
Q 1047	TRANSISTOR				DTC143ZE TL	G3070102		1-	A	F2
Q 1048	TRANSISTOR				DTC143ZE TL	G3070102		1-	A	G6
Q 1049	IC				M51132FP 600C	G1091930		1-	A	B4
Q 1050	TRANSISTOR				DTC144EUA T106	G3070041		1-	A	D4
Q 1051	TRANSISTOR				DTC143ZE TL	G3070102		1-	A	H1
Q 1052	TRANSISTOR				DTC143ZE TL	G3070102		1-	A	G5
Q 1053	TRANSISTOR				ISA1602AM1-T111-1F	G3070380		1-	A	E5
Q 1053	TRANSISTOR				2SA1576A T106 R	G3115768R		9-	A	E5
Q 1054	TRANSISTOR				DTC143ZE TL	G3070102		1-	A	H2
Q 1055	TRANSISTOR				ISA1602AM1-T111-1F	G3070380		1-	A	E5
Q 1055	TRANSISTOR				2SA1576A T106 R	G3115768R		9-	A	E5
Q 1056	TRANSISTOR				DTC143ZE TL	G3070102		1-	A	F2
Q 1057	IC				CD74HCT4053PWR	G1094273		1-	A	C5
Q 1058	TRANSISTOR				UMD5N TR	G3070343		1-	A	F2
Q 1059	TRANSISTOR				DTC143ZE TL	G3070102		1-	A	H2
Q 1060	IC				SPM5001-TL-E	G1093686		1-	A	F2
Q 1061	IC				HD74LV2G74A(TAPE)	G1093788		1-	A	B6
Q 1062	TRANSISTOR				2SC4154-T111-1E	G3341548E		1-	A	E5
Q 1062	TRANSISTOR				2SC4081 T106	G3340818		9-	A	E5
Q 1063	TRANSISTOR				UMD5N TR	G3070343		1-	A	F2
Q 1064	TRANSISTOR				DTC143ZE TL	G3070102		1-	A	H3
Q 1065	IC				SN74LVC1G66DCKR	G1094046		1-	A	E5
Q 1066	TRANSISTOR				DTC144EUA T106	G3070041		1-	A	E4
Q 1067	TRANSISTOR				2SC2714Y(TE85R.F)	G3327147Y		1-	A	E4

MAIN Unit

Parts List

REF	DESCRIPTION	VALUE	V/W	TOL.	MFR'S DESIG	VXSTD P/N	VERS.	LOT	SIDE	LAY ADR
Q 1068	TRANSISTOR				DTC143ZE TL	G3070102		1-	A	H3
Q 1069	TRANSISTOR				2SC4154-T111-1E	G3341548E		1-	A	E5
Q 1069	TRANSISTOR				2SC4081 T106	G3340818		9-	A	E5
Q 1070	IC				M62364FP 600D	G1093033		1-	A	B5
Q 1071	TRANSISTOR				DTC143ZE TL	G3070102		1-	A	F3
Q 1072	TRANSISTOR				2SC4154-T111-1E	G3341548E		1-	A	E1
Q 1072	TRANSISTOR				2SC4081 T106	G3340818		9-	A	E1
Q 1073	TRANSISTOR				DTC143ZE TL	G3070102		1-	A	H3
Q 1074	TRANSISTOR				2SC4154-T111-1E	G3341548E		1-	A	E6
Q 1074	TRANSISTOR				2SC4081 T106	G3340818		9-	A	E6
Q 1075	TRANSISTOR				DTC143ZE TL	G3070102		1-	A	F3
Q 1076	FET				SST310-T1	G4070009		1-	A	E3
Q 1077	TRANSISTOR				DTC143ZE TL	G3070102		1-	A	H4
Q 1078	TRANSISTOR				2SC4154-T111-1E	G3341548E		1-	A	F6
Q 1078	TRANSISTOR				2SC4081 T106	G3340818		9-	A	F6
Q 1079	FET				SST310-T1	G4070009		1-	A	E4
Q 1080	TRANSISTOR				DTC143ZE TL	G3070102		1-	A	F3
Q 1081	IC				UPC1678GV-E1	G1094126		1-	A	E2
Q 1082	IC				BB301CAW-TL	G1093186		1-	A	F5
Q 1083	IC				NJM2594V-TE1	G1093750		1-	A	E4
Q 1084	IC				BU2152FS(TAPE)	G1093942		1-	A	G1
Q 1085	TRANSISTOR				2SC4154-T111-1E	G3341548E		1-	A	C4
Q 1085	TRANSISTOR				2SC4081 T106	G3340818		9-	A	C4
Q 1086	IC				NJM78L05UA-TE1	G1091325		1-	A	E1
Q 1087	IC				LA4425A	G1092241		1-	A	A5
Q 1088	IC				BB301CAW-TL	G1093186		1-	A	F5
Q 1089	TRANSISTOR				2SC4154-T111-1E	G3341548E		1-	A	E5
Q 1089	TRANSISTOR				2SC4081 T106	G3340818		9-	A	E5
Q 1090	TRANSISTOR				DTC114EUA T106	G3070084		1-	A	D6
Q 1091	TRANSISTOR				ISA1602AM1-T111-1F	G3070380		1-	A	A5
Q 1091	TRANSISTOR				2SA1576A T106 R	G3115768R		9-	A	A5
Q 1092	TRANSISTOR				2SC4154-T111-1E	G3341548E		1-	A	A5
Q 1092	TRANSISTOR				2SC4081 T106	G3340818		9-	A	A5
Q 1093	FET				SST310-T1	G4070009		1-	A	F5
Q 1094	FET				SST310-T1	G4070009		1-	A	F5
Q 1095	TRANSISTOR				2SC4154-T111-1E	G3341548E		1-	A	A5
Q 1095	TRANSISTOR				2SC4081 T106	G3340818		9-	A	A5
Q 1097	IC				CD74HCT4053PWR	G1094273		1-	A	B5
Q 1098	IC				NJM2594V-TE1	G1093750		1-	A	D5
Q 1099	TRANSISTOR				2SC2714Y(TE85R.F)	G3327147Y		1-	A	F5
Q 1100	TRANSISTOR				UMD5N TR	G3070343		1-	A	A6
Q 1101	IC				BB301CAW-TL	G1093186		1-	A	F4
Q 1102	TRANSISTOR				2SC4154-T111-1E	G3341548E		1-	A	D5
Q 1102	TRANSISTOR				2SC4081 T106	G3340818		9-	A	D5
Q 1103	TRANSISTOR				2SC4154-T111-1E	G3341548E		1-	A	G5
Q 1103	TRANSISTOR				2SC4081 T106	G3340818		9-	A	G5
Q 1104	TRANSISTOR				2SC4154-T111-1E	G3341548E		1-	A	C5
Q 1104	TRANSISTOR				2SC4081 T106	G3340818		9-	A	C5
R 1001	CHIP RES.	220	1/16W	5%	RMC1/16 221JATP	J24185221		1-	A	E6
R 1002	CHIP RES.	100	1/16W	5%	RMC1/16 101JATP	J24185101		1-	A	G6
R 1003	CHIP RES.	470	1/16W	5%	RMC1/16 471JATP	J24185471		1-	A	H6
R 1004	CHIP RES.	0	1/16W	5%	RMC1/16 000JATP	J24185000		1-	A	C6
R 1005	CHIP RES.	10k	1/16W	5%	RMC1/16 103JATP	J24185103		1-	A	C6
R 1006	CHIP RES.	0	1/16W	5%	RMC1/16 000JATP	J24185000		1-	A	C6
R 1007	CHIP RES.	100	1/16W	5%	RMC1/16 101JATP	J24185101		1-	A	F6
R 1008	CHIP RES.	220	1/16W	5%	RMC1/16 221JATP	J24185221		1-	A	E6
R 1009	CHIP RES.	100	1/16W	5%	RMC1/16 101JATP	J24185101		1-	A	H6
R 1010	CHIP RES.	100	1/16W	5%	RMC1/16 101JATP	J24185101		1-	A	E6
R 1011	CHIP RES.	47	1/16W	5%	RMC1/16 470JATP	J24185470		1-	A	H6
R 1012	CHIP RES.	220	1/16W	5%	RMC1/16 221JATP	J24185221		1-	A	E6
R 1013	CHIP RES.	220	1/16W	5%	RMC1/16 221JATP	J24185221		1-	A	E6
R 1014	CHIP RES.	1k	1/16W	5%	RMC1/16 102JATP	J24185102		1-	A	F6
R 1015	CHIP RES.	100	1/16W	5%	RMC1/16 101JATP	J24185101		1-	A	F6
R 1016	CHIP RES.	100	1/16W	5%	RMC1/16 101JATP	J24185101		1-	A	F6
R 1017	CHIP RES.	0	1/16W	5%	RMC1/16 000JATP	J24185000		1-	A	C1
R 1018	CHIP RES.	220	1/16W	5%	RMC1/16 221JATP	J24185221		1-	A	E6
R 1019	CHIP RES.	100	1/16W	5%	RMC1/16 101JATP	J24185101		1-	A	G6
R 1020	CHIP RES.	47	1/16W	5%	RMC1/16 470JATP	J24185470		1-	A	C1
R 1021	CHIP RES.	100	1/16W	5%	RMC1/16 101JATP	J24185101		1-	A	H5
R 1022	CHIP RES.	4.7k	1/16W	5%	RMC1/16 472JATP	J24185472		1-	A	C1
R 1023	CHIP RES.	1k	1/16W	5%	RMC1/16 102JATP	J24185102		1-	A	F6
R 1024	CHIP RES.	1k	1/16W	5%	RMC1/16 102JATP	J24185102		1-	A	C1
R 1025	CHIP RES.	33	1/16W	5%	RMC1/16 330JATP	J24185330		1-	A	C1

MAIN Unit

Parts List

REF	DESCRIPTION	VALUE	V/W	TOL.	MFR'S DESIG	VXSTD P/N	VERS.	LOT	SIDE	LAY ADR
R 1026	CHIP RES.	1k	1/16W	5%	RMC1/16 102JATP	J24185102		1-	A	F6
R 1027	CHIP RES.	10k	1/16W	5%	RMC1/16 103JATP	J24185103		1-	A	C1
R 1028	CHIP RES.	22	1/16W	5%	RMC1/16 220JATP	J24185220		1-	A	C1
R 1029	CHIP RES.	68	1/16W	5%	RMC1/16 680JATP	J24185680		1-	A	H6
R 1030	CHIP RES.	150	1/16W	5%	RMC1/16 151JATP	J24185151		1-	A	H6
R 1031	CHIP RES.	100	1/16W	5%	RMC1/16 101JATP	J24185101		1-	A	F6
R 1032	CHIP RES.	100	1/16W	5%	RMC1/16 101JATP	J24185101		1-	A	G6
R 1033	CHIP RES.	150	1/16W	5%	RMC1/16 151JATP	J24185151		1-	A	C1
R 1035	CHIP RES.	470	1/16W	5%	RMC1/16 471JATP	J24185471		1-	A	A3
R 1036	CHIP RES.	0	1/16W	5%	RMC1/16 000JATP	J24185000		1-	A	B1
R 1037	CHIP RES.	1k	1/16W	5%	RMC1/16 102JATP	J24185102		1-	A	F6
R 1038	CHIP RES.	10k	1/16W	5%	RMC1/16 103JATP	J24185103		1-	A	C1
R 1039	CHIP RES.	470	1/16W	5%	RMC1/16 471JATP	J24185471		1-	A	A3
R 1040	CHIP RES.	22k	1/16W	5%	RMC1/16 223JATP	J24185223		1-	A	C1
R 1041	CHIP RES.	100	1/16W	5%	RMC1/16 101JATP	J24185101		1-	A	C1
R 1042	CHIP RES.	220	1/16W	5%	RMC1/16 221JATP	J24185221		1-	A	C1
R 1043	CHIP RES.	47k	1/16W	5%	RMC1/16 473JATP	J24185473		1-	A	C1
R 1044	CHIP RES.	8.2	1/16W	5%	RMC1/16 8R2JATP	J24185829		1-	A	B1
R 1045	CHIP RES.	47	1/2W	5%	RMC1/2 470JCTP	J24275470		1-	A	B1
R 1046	CHIP RES.	470	1/16W	5%	RMC1/16 471JATP	J24185471		1-	A	A3
R 1047	CHIP RES.	100	1/16W	5%	RMC1/16 101JATP	J24185101		1-	A	H5
R 1048	CHIP RES.	1k	1/16W	5%	RMC1/16 102JATP	J24185102		1-	A	G6
R 1049	CHIP RES.	4.7k	1/16W	5%	RMC1/16 472JATP	J24185472		1-	A	E6
R 1050	CHIP RES.	1k	1/16W	5%	RMC1/16 102JATP	J24185102		1-	A	E6
R 1051	CHIP RES.	680	1/16W	5%	RMC1/16 681JATP	J24185681		1-	A	B1
R 1052	CHIP RES.	220	1/4W	5%	RMC1/4 221JATP	J24245221		1-	A	B1
R 1053	CHIP RES.	330	1/16W	5%	RMC1/16 331JATP	J24185331		1-	A	B1
R 1054	CHIP RES.	47k	1/16W	5%	RMC1/16 473JATP	J24185473		1-	A	D1
R 1055	CHIP RES.	330	1/10W	5%	RMC1/10T 331J	J24205331		1-	A	C1
R 1056	CHIP RES.	1k	1/16W	5%	RMC1/16 102JATP	J24185102		1-	A	G6
R 1057	CHIP RES.	100k	1/16W	5%	RMC1/16 104JATP	J24185104		1-	A	G6
R 1058	CHIP RES.	47k	1/16W	5%	RMC1/16 473JATP	J24185473		1-	A	D1
R 1059	CHIP RES.	100	1/16W	5%	RMC1/16 101JATP	J24185101		1-	A	B1
R 1060	CHIP RES.	47k	1/16W	5%	RMC1/16 473JATP	J24185473		1-	A	D2
R 1061	CHIP RES.	33	1/16W	5%	RMC1/16 330JATP	J24185330		1-	A	H4
R 1062	CHIP RES.	0	1/16W	5%	RMC1/16 000JATP	J24185000		1-	A	A3
R 1063	CHIP RES.	0	1/16W	5%	RMC1/16 000JATP	J24185000		1-	A	A3
R 1064	CHIP RES.	1k	1/16W	5%	RMC1/16 102JATP	J24185102		1-	A	G6
R 1065	CHIP RES.	470	1/16W	5%	RMC1/16 471JATP	J24185471		1-	A	G6
R 1066	CHIP RES.	330	1/10W	5%	RMC1/10T 331J	J24205331		1-	A	H4
R 1067	CHIP RES.	10k	1/16W	5%	RMC1/16 103JATP	J24185103		1-	A	A5
R 1068	CHIP RES.	470	1/16W	5%	RMC1/16 471JATP	J24185471		1-	A	B3
R 1069	CHIP RES.	100	1/16W	5%	RMC1/16 101JATP	J24185101		1-	A	G5
R 1070	CHIP RES.	1k	1/16W	5%	RMC1/16 102JATP	J24185102		1-	A	A5
R 1071	CHIP RES.	330	1/10W	5%	RMC1/10T 331J	J24205331		1-	A	H4
R 1072	CHIP RES.	330	1/10W	5%	RMC1/10T 331J	J24205331		1-	A	H3
R 1073	CHIP RES.	330	1/10W	5%	RMC1/10T 331J	J24205331		1-	A	H3
R 1074	CHIP RES.	330	1/10W	5%	RMC1/10T 331J	J24205331		1-	A	H3
R 1075	CHIP RES.	470	1/16W	5%	RMC1/16 471JATP	J24185471		1-	A	B3
R 1076	CHIP RES.	47k	1/16W	5%	RMC1/16 473JATP	J24185473		1-	A	A5
R 1076	CHIP RES.	82k	1/16W	5%	RMC1/16 823JATP	J24185823		14-	A	A5
R 1077	CHIP RES.	470	1/16W	5%	RMC1/16 471JATP	J24185471		1-	A	B3
R 1078	CHIP RES.	0	1/16W	5%	RMC1/16 000JATP	J24185000		1-	A	H4
R 1079	CHIP RES.	330	1/10W	5%	RMC1/10T 331J	J24205331		1-	A	D1
R 1080	CHIP RES.	330	1/10W	5%	RMC1/10T 331J	J24205331		1-	A	D1
R 1081	CHIP RES.	330	1/10W	5%	RMC1/10T 331J	J24205331		1-	A	D2
R 1082	CHIP RES.	0	1/16W	5%	RMC1/16 000JATP	J24185000		1-	A	A3
R 1083	CHIP RES.	15k	1/16W	5%	RMC1/16 153JATP	J24185153		1-	A	A5
R 1083	CHIP RES.	22k	1/16W	5%	RMC1/16 223JATP	J24185223		14-	A	A5
R 1084	CHIP RES.	33	1/16W	5%	RMC1/16 330JATP	J24185330		1-	A	H4
R 1085	CHIP RES.	33	1/16W	5%	RMC1/16 330JATP	J24185330		1-	A	H3
R 1086	CHIP RES.	33	1/16W	5%	RMC1/16 330JATP	J24185330		1-	A	H3
R 1087	CHIP RES.	33	1/16W	5%	RMC1/16 330JATP	J24185330		1-	A	H3
R 1088	CHIP RES.	120k	1/16W	5%	RMC1/16 124JATP	J24185124		1-	A	A5
R 1089	CHIP RES.	33	1/16W	5%	RMC1/16 330JATP	J24185330		1-	A	D1
R 1090	CHIP RES.	33	1/16W	5%	RMC1/16 330JATP	J24185330		1-	A	D2
R 1091	CHIP RES.	33	1/16W	5%	RMC1/16 330JATP	J24185330		1-	A	D2
R 1093	CHIP RES.	330	1/10W	5%	RMC1/10T 331J	J24205331		1-	A	G4
R 1094	CHIP RES.	330	1/10W	5%	RMC1/10T 331J	J24205331		1-	A	G3
R 1095	CHIP RES.	330	1/10W	5%	RMC1/10T 331J	J24205331		1-	A	G3
R 1096	CHIP RES.	330	1/10W	5%	RMC1/10T 331J	J24205331		1-	A	G3
R 1097	CHIP RES.	330	1/10W	5%	RMC1/10T 331J	J24205331		1-	A	D1
R 1098	CHIP RES.	330	1/10W	5%	RMC1/10T 331J	J24205331		1-	A	D1

MAIN Unit

Parts List

REF	DESCRIPTION	VALUE	V/W	TOL.	MFR'S DESIG	VXSTD P/N	VERS.	LOT	SIDE	LAY ADR
R 1099	CHIP RES.	330	1/10W	5%	RMC1/10T 331J	J24205331		1-	A	D2
R 1100	CHIP RES.	470	1/16W	5%	RMC1/16 471JATP	J24185471		1-	A	A3
R 1101	CHIP RES.	470	1/16W	5%	RMC1/16 471JATP	J24185471		1-	A	A3
R 1102	CHIP RES.	330k	1/16W	5%	RMC1/16 334JATP	J24185334		1-	A	B2
R 1103	CHIP RES.	10	1/16W	5%	RMC1/16 100JATP	J24185100		1-	A	C2
R 1104	CHIP RES.	0	1/16W	5%	RMC1/16 000JATP	J24185000		1-	A	B2
R 1105	CHIP RES.	4.7k	1/16W	5%	RMC1/16 472JATP	J24185472		1-	A	C2
R 1106	CHIP RES.	4.7k	1/16W	5%	RMC1/16 472JATP	J24185472		1-	A	C2
R 1107	CHIP RES.	330	1/10W	5%	RMC1/10T 331J	J24205331		1-	A	D2
R 1108	CHIP RES.	470k	1/16W	5%	RMC1/16 474JATP	J24185474		1-	A	B2
R 1109	CHIP RES.	470	1/16W	5%	RMC1/16 471JATP	J24185471		1-	A	C2
R 1110	CHIP RES.	470	1/16W	5%	RMC1/16 471JATP	J24185471		1-	A	C2
R 1111	CHIP RES.	470	1/16W	5%	RMC1/16 471JATP	J24185471		1-	A	C2
R 1112	CHIP RES.	47	1/16W	5%	RMC1/16 470JATP	J24185470		1-	A	B2
R 1113	CHIP RES.	330	1/10W	5%	RMC1/10T 331J	J24205331		1-	A	H2
R 1114	CHIP RES.	330	1/10W	5%	RMC1/10T 331J	J24205331		1-	A	H2
R 1115	CHIP RES.	330	1/10W	5%	RMC1/10T 331J	J24205331		1-	A	H1
R 1116	CHIP RES.	100	1/16W	5%	RMC1/16 101JATP	J24185101		1-	A	H5
R 1117	CHIP RES.	22k	1/16W	5%	RMC1/16 223JATP	J24185223		1-	A	B2
R 1118	CHIP RES.	1k	1/16W	5%	RMC1/16 102JATP	J24185102		1-	A	B2
R 1119	CHIP RES.	1M	1/16W	5%	RMC1/16 105JATP	J24185105		1-	A	B2
R 1120	CHIP RES.	27	1/16W	5%	RMC1/16 270JATP	J24185270		1-	A	H5
R 1121	CHIP RES.	27	1/16W	5%	RMC1/16 270JATP	J24185270		1-	A	H5
R 1122	CHIP RES.	22k	1/16W	1%	RMC1/16 223FTP	J24183223		1-	A	D4
R 1123	CHIP RES.	33	1/16W	5%	RMC1/16 330JATP	J24185330		1-	A	H5
R 1124	CHIP RES.	22k	1/16W	1%	RMC1/16 223FTP	J24183223		1-	A	D4
R 1125	CHIP RES.	15k	1/16W	5%	RMC1/16 153JATP	J24185153		1-	A	B2
R 1126	CHIP RES.	47k	1/16W	1%	RMC1/16 473FTP	J24183473		1-	A	D4
R 1126	CHIP RES.	43k	1/16W	1%	RMC1/16 433FTP	J24183433		5-	A	D4
R 1127	CHIP RES.	47k	1/16W	1%	RMC1/16 473FTP	J24183473		1-	A	D4
R 1127	CHIP RES.	43k	1/16W	1%	RMC1/16 433FTP	J24183433		5-	A	D4
R 1129	CHIP RES.	10	1/16W	5%	RMC1/16 100JATP	J24185100		1-	A	E2
R 1130	CHIP RES.	33	1/16W	5%	RMC1/16 330JATP	J24185330		1-	A	H2
R 1131	CHIP RES.	33	1/16W	5%	RMC1/16 330JATP	J24185330		1-	A	H2
R 1132	CHIP RES.	33	1/16W	5%	RMC1/16 330JATP	J24185330		1-	A	H1
R 1133	CHIP RES.	47	1/16W	5%	RMC1/16 470JATP	J24185470		1-	A	B2
R 1134	CHIP RES.	47	1/16W	5%	RMC1/16 470JATP	J24185470		1-	A	C5
R 1135	CHIP RES.	1k	1/16W	5%	RMC1/16 102JATP	J24185102		1-	A	C5
R 1136	CHIP RES.	150	1/16W	5%	RMC1/16 151JATP	J24185151		1-	A	E2
R 1137	CHIP RES.	330	1/10W	5%	RMC1/10T 331J	J24205331		1-	A	G2
R 1138	CHIP RES.	330	1/10W	5%	RMC1/10T 331J	J24205331		1-	A	G2
R 1139	CHIP RES.	330	1/10W	5%	RMC1/10T 331J	J24205331		1-	A	G1
R 1140	CHIP RES.	10	1/16W	5%	RMC1/16 100JATP	J24185100		1-	A	E2
R 1141	CHIP RES.	4.7k	1/16W	1%	RMC1/16 472FTP	J24183472		1-	A	D4
R 1142	CHIP RES.	4.7k	1/16W	1%	RMC1/16 472FTP	J24183472		1-	A	D4
R 1143	CHIP RES.	3.3M	1/16W	5%	RMC1/16 335JATP	J24185335		1-	A	C5
R 1144	CHIP RES.	100k	1/16W	5%	RMC1/16 104JATP	J24185104		1-	A	C4
R 1145	CHIP RES.	4.7k	1/16W	1%	RMC1/16 472FTP	J24183472		1-	A	D4
R 1146	CHIP RES.	1k	1/16W	5%	RMC1/16 102JATP	J24185102		1-	A	D3
R 1147	CHIP RES.	10k	1/16W	5%	RMC1/16 103JATP	J24185103		1-	A	C4
R 1148	CHIP RES.	4.7k	1/16W	1%	RMC1/16 472FTP	J24183472		1-	A	D4
R 1149	CHIP RES.	330	1/10W	5%	RMC1/10T 331J	J24205331		1-	A	G4
R 1150	CHIP RES.	33	1/16W	5%	RMC1/16 330JATP	J24185330		1-	A	G4
R 1151	CHIP RES.	10k	1/16W	5%	RMC1/16 103JATP	J24185103		1-	A	C5
R 1152	CHIP RES.	68k	1/16W	5%	RMC1/16 683JATP	J24185683		1-	A	C4
R 1153	CHIP RES.	330	1/10W	5%	RMC1/10T 331J	J24205331		1-	A	F2
R 1154	CHIP RES.	68	1/16W	5%	RMC1/16 680JATP	J24185680		1-	A	F2
R 1155	CHIP RES.	150	1/16W	5%	RMC1/16 151JATP	J24185151		1-	A	D3
R 1156	CHIP RES.	100k	1/16W	5%	RMC1/16 104JATP	J24185104		1-	A	D4
R 1157	CHIP RES.	68k	1/16W	5%	RMC1/16 683JATP	J24185683		1-	A	D4
R 1158	CHIP RES.	10k	1/16W	5%	RMC1/16 103JATP	J24185103		1-	A	C5
R 1159	CHIP RES.	33k	1/16W	5%	RMC1/16 333JATP	J24185333		1-	A	C4
R 1160	CHIP RES.	150k	1/16W	5%	RMC1/16 154JATP	J24185154		1-	A	D4
R 1161	CHIP RES.	150k	1/16W	5%	RMC1/16 154JATP	J24185154		1-	A	D4
R 1162	CHIP RES.	10k	1/16W	5%	RMC1/16 103JATP	J24185103		1-	A	C4
R 1163	CHIP RES.	1k	1/16W	5%	RMC1/16 102JATP	J24185102		1-	A	F1
R 1164	CHIP RES.	4.7k	1/16W	5%	RMC1/16 472JATP	J24185472		1-	A	F2
R 1165	CHIP RES.	33	1/16W	5%	RMC1/16 330JATP	J24185330		1-	A	E3
R 1166	CHIP RES.	220k	1/16W	5%	RMC1/16 224JATP	J24185224		1-	A	C4
R 1167	CHIP RES.	470k	1/16W	5%	RMC1/16 474JATP	J24185474		1-	A	C5
R 1168	CHIP RES.	47k	1/16W	1%	RMC1/16 473FTP	J24183473		1-	A	B2
R 1169	CHIP RES.	100	1/16W	5%	RMC1/16 101JATP	J24185101		1-	A	F1
R 1170	CHIP RES.	150	1/10W	5%	RMC1/10T 151J	J24205151		1-	A	F1

MAIN Unit

Parts List

REF	DESCRIPTION	VALUE	V/W	TOL.	MFR'S DESIG	VXSTD P/N	VERS.	LOT	SIDE	LAY ADR
R 1170	CHIP RES.	47	1/10W	5%	RMC1/10T 470J	J24205470		26-	A	F1
R 1171	CHIP RES.	47k	1/16W	1%	RMC1/16 473FTP	J24183473		1-	A	B2
R 1172	CHIP RES.	47	1/16W	5%	RMC1/16 470JATP	J24185470		1-	A	C4
R 1173	CHIP RES.	100	1/16W	5%	RMC1/16 101JATP	J24185101		1-	A	E3
R 1174	CHIP RES.	47k	1/16W	5%	RMC1/16 473JATP	J24185473		1-	A	D4
R 1175	CHIP RES.	100k	1/16W	1%	RMC1/16 104FTP	J24183104		1-	A	B2
R 1176	CHIP RES.	10k	1/16W	5%	RMC1/16 103JATP	J24185103		1-	A	D4
R 1177	CHIP RES.	4.7k	1/16W	5%	RMC1/16 472JATP	J24185472		1-	A	C5
R 1178	CHIP RES.	100k	1/16W	1%	RMC1/16 104FTP	J24183104		1-	A	B2
R 1179	CHIP RES.	33	1/16W	5%	RMC1/16 330JATP	J24185330		1-	A	D3
R 1180	CHIP RES.	4.7k	1/16W	5%	RMC1/16 472JATP	J24185472		1-	A	D4
R 1181	CHIP RES.	4.7k	1/16W	5%	RMC1/16 472JATP	J24185472		1-	A	B3
R 1182	CHIP RES.	33	1/16W	5%	RMC1/16 330JATP	J24185330		1-	A	F1
R 1183	CHIP RES.	1k	1/16W	5%	RMC1/16 102JATP	J24185102		1-	A	F1
R 1183	CHIP RES.	330	1/16W	5%	RMC1/16 331JATP	J24185331		26-	A	F1
R 1184	CHIP RES.	1k	1/16W	5%	RMC1/16 102JATP	J24185102		1-	A	F1
R 1185	CHIP RES.	470k	1/16W	5%	RMC1/16 474JATP	J24185474		1-	A	D4
R 1186	CHIP RES.	10k	1/16W	5%	RMC1/16 103JATP	J24185103		1-	A	C5
R 1187	CHIP RES.	100k	1/16W	5%	RMC1/16 104JATP	J24185104		1-	A	C4
R 1189	CHIP RES.	47k	1/16W	5%	RMC1/16 473JATP	J24185473		1-	A	E4
R 1190	CHIP RES.	47k	1/16W	5%	RMC1/16 473JATP	J24185473		1-	A	F2
R 1191	CHIP RES.	0	1/16W	5%	RMC1/16 000JATP	J24185000		1-	A	C5
R 1192	CHIP RES.	100	1/16W	5%	RMC1/16 101JATP	J24185101		1-	A	E3
R 1193	CHIP RES.	47	1/16W	5%	RMC1/16 470JATP	J24185470		1-	A	D5
R 1194	CHIP RES.	10	1/16W	5%	RMC1/16 100JATP	J24185100		1-	A	F1
R 1195	CHIP RES.	4.7k	1/16W	1%	RMC1/16 472FTP	J24183472		1-	A	B2
R 1196	CHIP RES.	10k	1/16W	5%	RMC1/16 103JATP	J24185103		1-	A	E4
R 1197	CHIP RES.	330	1/16W	5%	RMC1/16 331JATP	J24185331		1-	A	E1
R 1198	CHIP RES.	18	1/16W	5%	RMC1/16 180JATP	J24185180		1-	A	F1
R 1199	CHIP RES.	10	1/16W	5%	RMC1/16 100JATP	J24185100		1-	A	E1
R 1200	CHIP RES.	1k	1/16W	5%	RMC1/16 102JATP	J24185102		1-	A	F1
R 1201	CHIP RES.	0	1/16W	5%	RMC1/16 000JATP	J24185000		1-	A	D5
R 1202	CHIP RES.	39k	1/16W	5%	RMC1/16 393JATP	J24185393		1-	A	E4
R 1203	CHIP RES.	4.7k	1/16W	1%	RMC1/16 472FTP	J24183472		1-	A	B2
R 1204	CHIP RES.	100	1/16W	5%	RMC1/16 101JATP	J24185101		1-	A	C4
R 1205	CHIP RES.	47	1/16W	5%	RMC1/16 470JATP	J24185470		1-	A	D3
R 1206	CHIP RES.	10k	1/16W	5%	RMC1/16 103JATP	J24185103		1-	A	D3
R 1207	CHIP RES.	3.9k	1/16W	5%	RMC1/16 392JATP	J24185392		1-	A	D3
R 1208	CHIP RES.	10k	1/16W	5%	RMC1/16 103JATP	J24185103		1-	A	C5
R 1209	CHIP RES.	100k	1/16W	5%	RMC1/16 104JATP	J24185104		1-	A	D4
R 1210	CHIP RES.	150	1/10W	5%	RMC1/10T 151J	J24205151		1-	A	F1
R 1210	CHIP RES.	47	1/10W	5%	RMC1/10T 470J	J24205470		26-	A	F1
R 1211	CHIP RES.	330	1/16W	5%	RMC1/16 331JATP	J24185331		1-	A	E1
R 1212	CHIP RES.	22k	1/16W	5%	RMC1/16 223JATP	J24185223		1-	A	D3
R 1213	CHIP RES.	2.2k	1/16W	5%	RMC1/16 222JATP	J24185222		1-	A	D3
R 1214	CHIP RES.	10k	1/16W	5%	RMC1/16 103JATP	J24185103		1-	A	D3
R 1215	CHIP RES.	2.2k	1/16W	5%	RMC1/16 222JATP	J24185222		1-	A	C3
R 1216	CHIP RES.	150k	1/16W	5%	RMC1/16 154JATP	J24185154		1-	A	C5
R 1217	CHIP RES.	100k	1/16W	5%	RMC1/16 104JATP	J24185104		1-	A	E4
R 1218	CHIP RES.	470k	1/16W	5%	RMC1/16 474JATP	J24185474		1-	A	C3
R 1219	CHIP RES.	10k	1/16W	5%	RMC1/16 103JATP	J24185103		1-	A	D5
R 1220	CHIP RES.	47	1/16W	5%	RMC1/16 470JATP	J24185470		1-	A	D3
R 1221	CHIP RES.	68k	1/16W	5%	RMC1/16 683JATP	J24185683		1-	A	D5
R 1222	CHIP RES.	2.2k	1/16W	5%	RMC1/16 222JATP	J24185222		1-	A	C2
R 1223	CHIP RES.	150k	1/16W	5%	RMC1/16 154JATP	J24185154		1-	A	D4
R 1224	CHIP RES.	2.2k	1/16W	5%	RMC1/16 222JATP	J24185222		1-	A	C3
R 1225	CHIP RES.	6.8k	1/16W	5%	RMC1/16 682JATP	J24185682		1-	A	C5
R 1226	CHIP RES.	47	1/16W	5%	RMC1/16 470JATP	J24185470		1-	A	D3
R 1227	CHIP RES.	33	1/16W	5%	RMC1/16 330JATP	J24185330		1-	A	F1
R 1228	CHIP RES.	1k	1/16W	5%	RMC1/16 102JATP	J24185102		1-	A	F1
R 1228	CHIP RES.	330	1/16W	5%	RMC1/16 331JATP	J24185331		26-	A	F1
R 1229	CHIP RES.	3.3k	1/16W	5%	RMC1/16 332JATP	J24185332		1-	A	C3
R 1230	CHIP RES.	1k	1/16W	5%	RMC1/16 102JATP	J24185102		1-	A	F1
R 1231	CHIP RES.	0	1/16W	5%	RMC1/16 000JATP	J24185000		1-	A	C5
R 1232	CHIP RES.	470k	1/16W	5%	RMC1/16 474JATP	J24185474		1-	A	C3
R 1233	CHIP RES.	100	1/16W	5%	RMC1/16 101JATP	J24185101		1-	A	F1
R 1234	CHIP RES.	2.2k	1/16W	5%	RMC1/16 222JATP	J24185222		1-	A	C2
R 1235	CHIP RES.	10k	1/16W	5%	RMC1/16 103JATP	J24185103		1-	A	C4
R 1236	CHIP RES.	220	1/16W	5%	RMC1/16 221JATP	J24185221		1-	A	C4
R 1237	CHIP RES.	10	1/16W	5%	RMC1/16 100JATP	J24185100		1-	A	F1
R 1238	CHIP RES.	330k	1/16W	5%	RMC1/16 334JATP	J24185334		1-	A	C3
R 1239	CHIP RES.	47k	1/16W	5%	RMC1/16 473JATP	J24185473		1-	A	D4
R 1240	CHIP RES.	10	1/16W	5%	RMC1/16 100JATP	J24185100		1-	A	F1

MAIN Unit

Parts List

REF	DESCRIPTION	VALUE	V/W	TOL.	MFR'S DESIG	VXSTD P/N	VERS.	LOT	SIDE	LAY ADR
R 1241	CHIP RES.	10k	1/16W	5%	RMC1/16 103JATP	J24185103		1-	A	D5
R 1242	CHIP RES.	100	1/16W	5%	RMC1/16 101JATP	J24185101		1-	A	D3
R 1243	CHIP RES.	100k	1/16W	5%	RMC1/16 104JATP	J24185104		1-	A	C4
R 1244	CHIP RES.	33k	1/16W	5%	RMC1/16 333JATP	J24185333		1-	A	C3
R 1245	CHIP RES.	47	1/16W	5%	RMC1/16 470JATP	J24185470		1-	A	B4
R 1246	CHIP RES.	100k	1/16W	5%	RMC1/16 104JATP	J24185104		1-	A	D3
R 1247	CHIP RES.	10k	1/16W	5%	RMC1/16 103JATP	J24185103		1-	A	D4
R 1249	CHIP RES.	330	1/10W	5%	RMC1/10T 331J	J24205331		1-	A	F2
R 1250	CHIP RES.	10k	1/16W	5%	RMC1/16 103JATP	J24185103		1-	A	C3
R 1251	CHIP RES.	47	1/16W	5%	RMC1/16 470JATP	J24185470		1-	A	D5
R 1252	CHIP RES.	15k	1/16W	5%	RMC1/16 153JATP	J24185153		1-	A	E6
R 1253	CHIP RES.	470	1/16W	5%	RMC1/16 471JATP	J24185471		1-	A	D4
R 1254	CHIP RES.	47k	1/16W	5%	RMC1/16 473JATP	J24185473		1-	A	C3
R 1255	CHIP RES.	33k	1/16W	5%	RMC1/16 333JATP	J24185333		1-	A	C3
R 1256	CHIP RES.	68	1/16W	5%	RMC1/16 680JATP	J24185680		1-	A	F2
R 1257	CHIP RES.	22k	1/16W	5%	RMC1/16 223JATP	J24185223		1-	A	E5
R 1259	CHIP RES.	100k	1/16W	5%	RMC1/16 104JATP	J24185104		1-	A	D4
R 1260	CHIP RES.	10k	1/16W	5%	RMC1/16 103JATP	J24185103		1-	A	C3
R 1261	CHIP RES.	100k	1/16W	5%	RMC1/16 104JATP	J24185104		1-	A	E5
R 1262	CHIP RES.	1k	1/16W	5%	RMC1/16 102JATP	J24185102		1-	A	C3
R 1263	CHIP RES.	1.5k	1/16W	5%	RMC1/16 152JATP	J24185152		1-	A	D3
R 1264	CHIP RES.	10k	1/16W	5%	RMC1/16 103JATP	J24185103		1-	A	D4
R 1265	CHIP RES.	390	1/16W	5%	RMC1/16 391JATP	J24185391		1-	A	F2
R 1266	CHIP RES.	470k	1/16W	5%	RMC1/16 474JATP	J24185474		1-	A	D4
R 1267	CHIP RES.	2.2k	1/16W	5%	RMC1/16 222JATP	J24185222		1-	A	D3
R 1268	CHIP RES.	68k	1/16W	5%	RMC1/16 683JATP	J24185683		1-	A	C3
R 1269	CHIP RES.	47k	1/16W	1%	RMC1/16 473FTP	J24183473		1-	A	D4
R 1270	CHIP RES.	10k	1/16W	5%	RMC1/16 103JATP	J24185103		1-	A	B5
R 1271	CHIP RES.	39k	1/16W	5%	RMC1/16 393JATP	J24185393		1-	A	D5
R 1272	CHIP RES.	10k	1/16W	5%	RMC1/16 103JATP	J24185103		1-	A	D4
R 1273	CHIP RES.	10k	1/16W	5%	RMC1/16 103JATP	J24185103		1-	A	C3
R 1274	CHIP RES.	22k	1/16W	5%	RMC1/16 223JATP	J24185223		1-	A	E5
R 1275	CHIP RES.	2.2k	1/16W	5%	RMC1/16 222JATP	J24185222		1-	A	D5
R 1276	CHIP RES.	560	1/16W	5%	RMC1/16 561JATP	J24185561		1-	A	D4
R 1277	CHIP RES.	330	1/10W	5%	RMC1/10T 331J	J24205331		1-	A	E2
R 1278	CHIP RES.	270	1/16W	5%	RMC1/16 271JATP	J24185271		1-	A	E2
R 1279	CHIP RES.	47k	1/16W	5%	RMC1/16 473JATP	J24185473		1-	A	H1
R 1280	CHIP RES.	18	1/16W	5%	RMC1/16 180JATP	J24185180		1-	A	E3
R 1281	CHIP RES.	10k	1/16W	5%	RMC1/16 103JATP	J24185103		1-	A	B5
R 1282	CHIP RES.	100k	1/16W	5%	RMC1/16 104JATP	J24185104		1-	A	C3
R 1283	CHIP RES.	10k	1/16W	5%	RMC1/16 103JATP	J24185103		1-	A	B3
R 1284	CHIP RES.	10k	1/16W	5%	RMC1/16 103JATP	J24185103		1-	A	C3
R 1285	CHIP RES.	100	1/16W	5%	RMC1/16 101JATP	J24185101		1-	A	E2
R 1286	CHIP RES.	180	1/16W	5%	RMC1/16 181JATP	J24185181		1-	A	D3
R 1287	CHIP RES.	3.3k	1/16W	5%	RMC1/16 332JATP	J24185332		1-	A	D3
R 1288	CHIP RES.	47k	1/16W	1%	RMC1/16 473FTP	J24183473		1-	A	D4
R 1289	CHIP RES.	100k	1/16W	1%	RMC1/16 104FTP	J24183104		1-	A	D4
R 1290	CHIP RES.	270	1/16W	5%	RMC1/16 271JATP	J24185271		1-	A	E3
R 1291	CHIP RES.	1.5k	1/16W	5%	RMC1/16 152JATP	J24185152		1-	A	D3
R 1292	CHIP RES.	22k	1/16W	5%	RMC1/16 223JATP	J24185223		1-	A	E5
R 1293	CHIP RES.	5.6k	1/16W	5%	RMC1/16 562JATP	J24185562		1-	A	D5
R 1294	CHIP RES.	33k	1/16W	5%	RMC1/16 333JATP	J24185333		1-	A	B5
R 1295	CHIP RES.	100k	1/16W	1%	RMC1/16 104FTP	J24183104		1-	A	D4
R 1296	CHIP RES.	270	1/10W	5%	RMC1/10T 271J	J24205271		1-	A	E3
R 1297	CHIP RES.	47	1/10W	5%	RMC1/10T 470J	J24205470		1-	A	E3
R 1299	CHIP RES.	47k	1/16W	5%	RMC1/16 473JATP	J24185473		1-	A	H2
R 1300	CHIP RES.	47	1/16W	5%	RMC1/16 470JATP	J24185470		1-	A	C5
R 1302	CHIP RES.	1k	1/16W	5%	RMC1/16 102JATP	J24185102		1-	A	E4
R 1303	CHIP RES.	68	1/16W	5%	RMC1/16 680JATP	J24185680		1-	A	F2
R 1304	CHIP RES.	68	1/16W	5%	RMC1/16 680JATP	J24185680		1-	A	F2
R 1305	CHIP RES.	100k	1/16W	5%	RMC1/16 104JATP	J24185104		1-	A	E5
R 1305	CHIP RES.	10k	1/16W	5%	RMC1/16 103JATP	J24185103		9-	A	E5
R 1306	CHIP RES.	4.7k	1/16W	5%	RMC1/16 472JATP	J24185472		1-	A	D4
R 1307	CHIP RES.	4.7k	1/16W	5%	RMC1/16 472JATP	J24185472		1-	A	D4
R 1309	CHIP RES.	0	1/16W	5%	RMC1/16 000JATP	J24185000		1-	A	D5
R 1310	CHIP RES.	33k	1/16W	5%	RMC1/16 333JATP	J24185333		1-	A	C5
R 1311	CHIP RES.	47k	1/16W	5%	RMC1/16 473JATP	J24185473		1-	A	E5
R 1312	CHIP RES.	3.3k	1/16W	5%	RMC1/16 332JATP	J24185332		1-	A	E5
R 1313	CHIP RES.	47	1/16W	5%	RMC1/16 470JATP	J24185470		1-	A	C3
R 1314	CHIP RES.	10k	1/16W	5%	RMC1/16 103JATP	J24185103		1-	A	C6
R 1316	CHIP RES.	47	1/16W	5%	RMC1/16 470JATP	J24185470		1-	A	C5
R 1317	CHIP RES.	47	1/16W	5%	RMC1/16 470JATP	J24185470		1-	A	E3
R 1318	CHIP RES.	47k	1/16W	5%	RMC1/16 473JATP	J24185473		1-	A	H2

MAIN Unit

Parts List

REF	DESCRIPTION	VALUE	V/W	TOL.	MFR'S DESIG	VXSTD P/N	VERS.	LOT	SIDE	LAY ADR
R 1319	CHIP RES.	470	1/16W	5%	RMC1/16 471JATP	J24185471		1-	A	F2
R 1320	CHIP RES.	100k	1/16W	5%	RMC1/16 104JATP	J24185104		1-	A	E6
R 1320	CHIP RES.	150k	1/16W	5%	RMC1/16 154JATP	J24185154		9-	A	E6
R 1321	CHIP RES.	68k	1/16W	5%	RMC1/16 683JATP	J24185683		1-	A	E6
R 1322	CHIP RES.	10k	1/16W	5%	RMC1/16 103JATP	J24185103		1-	A	B6
R 1323	CHIP RES.	470	1/16W	5%	RMC1/16 471JATP	J24185471		1-	A	B5
R 1325	CHIP RES.	4.7k	1/16W	5%	RMC1/16 472JATP	J24185472		1-	A	E1
R 1326	CHIP RES.	470	1/16W	5%	RMC1/16 471JATP	J24185471		1-	A	B5
R 1327	CHIP RES.	1k	1/16W	5%	RMC1/16 102JATP	J24185102		1-	A	E2
R 1328	CHIP RES.	0	1/16W	5%	RMC1/16 000JATP	J24185000		1-	A	F2
R 1329	CHIP RES.	0	1/16W	5%	RMC1/16 000JATP	J24185000		1-	A	D5
R 1331	CHIP RES.	0	1/16W	5%	RMC1/16 000JATP	J24185000		1-	A	F2
R 1332	CHIP RES.	150k	1/16W	5%	RMC1/16 154JATP	J24185154		1-	A	E6
R 1332	CHIP RES.	15k	1/16W	5%	RMC1/16 153JATP	J24185153		9-	A	E6
R 1333	CHIP RES.	470	1/16W	5%	RMC1/16 471JATP	J24185471		1-	A	B5
R 1334	CHIP RES.	100	1/16W	5%	RMC1/16 101JATP	J24185101		1-	A	E4
R 1335	CHIP RES.	47k	1/16W	5%	RMC1/16 473JATP	J24185473		1-	A	H3
R 1336	CHIP RES.	47k	1/16W	5%	RMC1/16 473JATP	J24185473		1-	A	E5
R 1336	CHIP RES.	100k	1/16W	5%	RMC1/16 104JATP	J24185104		9-	A	E5
R 1337	CHIP RES.	33k	1/16W	5%	RMC1/16 333JATP	J24185333		1-	A	B5
R 1338	CHIP RES.	4.7	1/10W	5%	RMC1/10T 4R7J	J24205479		1-	A	F2
R 1339	CHIP RES.	68k	1/16W	5%	RMC1/16 683JATP	J24185683		1-	A	E5
R 1339	CHIP RES.	100k	1/16W	5%	RMC1/16 104JATP	J24185104		9-	A	E5
R 1341	CHIP RES.	3.3k	1/16W	5%	RMC1/16 332JATP	J24185332		1-	A	E4
R 1342	CHIP RES.	0	1/16W	5%	RMC1/16 000JATP	J24185000		1-	A	E4
R 1343	CHIP RES.	10k	1/16W	5%	RMC1/16 103JATP	J24185103		1-	A	E4
R 1344	CHIP RES.	10k	1/16W	5%	RMC1/16 103JATP	J24185103		1-	A	E2
R 1345	CHIP RES.	47k	1/16W	5%	RMC1/16 473JATP	J24185473		1-	A	H3
R 1346	CHIP RES.	1.5k	1/16W	5%	RMC1/16 152JATP	J24185152		1-	A	E4
R 1347	CHIP RES.	100k	1/16W	5%	RMC1/16 104JATP	J24185104		1-	A	C6
R 1348	CHIP RES.	100k	1/16W	5%	RMC1/16 104JATP	J24185104		1-	A	C5
R 1349	CHIP RES.	10k	1/16W	5%	RMC1/16 103JATP	J24185103		1-	A	E4
R 1350	CHIP RES.	47k	1/16W	5%	RMC1/16 473JATP	J24185473		1-	A	G3
R 1351	CHIP RES.	10k	1/16W	5%	RMC1/16 103JATP	J24185103		1-	A	C6
R 1352	CHIP RES.	33	1/16W	5%	RMC1/16 330JATP	J24185330		1-	A	E3
R 1353	CHIP RES.	100	1/16W	5%	RMC1/16 101JATP	J24185101		1-	A	E5
R 1354	CHIP RES.	1k	1/16W	5%	RMC1/16 102JATP	J24185102		1-	A	E6
R 1355	CHIP RES.	100k	1/16W	5%	RMC1/16 104JATP	J24185104		1-	A	E6
R 1356	CHIP RES.	10k	1/16W	5%	RMC1/16 103JATP	J24185103		1-	A	C5
R 1357	CHIP RES.	4.7	1/10W	5%	RMC1/10T 4R7J	J24205479		1-	A	F2
R 1358	CHIP RES.	1.5k	1/16W	5%	RMC1/16 152JATP	J24185152		1-	A	E4
R 1359	CHIP RES.	4.7k	1/16W	5%	RMC1/16 472JATP	J24185472		1-	A	B5
R 1360	CHIP RES.	10k	1/16W	5%	RMC1/16 103JATP	J24185103		1-	A	C5
R 1361	CHIP RES.	10k	1/16W	5%	RMC1/16 103JATP	J24185103		1-	A	F6
R 1362	CHIP RES.	100	1/16W	5%	RMC1/16 101JATP	J24185101		1-	A	E4
R 1363	CHIP RES.	270	1/16W	5%	RMC1/16 271JATP	J24185271		1-	A	E4
R 1364	CHIP RES.	6.8k	1/16W	5%	RMC1/16 682JATP	J24185682		1-	A	B5
R 1365	CHIP RES.	47k	1/16W	5%	RMC1/16 473JATP	J24185473		1-	A	H3
R 1366	CHIP RES.	68k	1/16W	5%	RMC1/16 683JATP	J24185683		1-	A	B5
R 1367	CHIP RES.	100k	1/16W	5%	RMC1/16 104JATP	J24185104		1-	A	C5
R 1368	CHIP RES.	100k	1/16W	5%	RMC1/16 104JATP	J24185104		1-	A	C5
R 1369	CHIP RES.	10	1/16W	5%	RMC1/16 100JATP	J24185100		1-	A	E1
R 1370	CHIP RES.	47	1/16W	5%	RMC1/16 470JATP	J24185470		1-	A	E5
R 1371	CHIP RES.	47k	1/16W	5%	RMC1/16 473JATP	J24185473		1-	A	G3
R 1372	CHIP RES.	100	1/16W	5%	RMC1/16 101JATP	J24185101		1-	A	F3
R 1373	CHIP RES.	47	1/16W	5%	RMC1/16 470JATP	J24185470		1-	A	A5
R 1374	CHIP RES.	1k	1/16W	5%	RMC1/16 102JATP	J24185102		1-	A	C4
R 1375	CHIP RES.	100	1/16W	5%	RMC1/16 101JATP	J24185101		1-	A	F3
R 1376	CHIP RES.	22k	1/16W	5%	RMC1/16 223JATP	J24185223		1-	A	A5
R 1377	CHIP RES.	100k	1/16W	5%	RMC1/16 104JATP	J24185104		1-	A	B5
R 1378	CHIP RES.	1k	1/16W	5%	RMC1/16 102JATP	J24185102		1-	A	C4
R 1379	CHIP RES.	47	1/16W	5%	RMC1/16 470JATP	J24185470		1-	A	E5
R 1380	CHIP RES.	330	1/10W	5%	RMC1/10T 331J	J24205331		1-	A	F3
R 1382	CHIP RES.	2.2k	1/16W	5%	RMC1/16 222JATP	J24185222		1-	A	E5
R 1383	CHIP RES.	33k	1/16W	5%	RMC1/16 333JATP	J24185333		1-	A	A5
R 1384	CHIP RES.	100k	1/16W	5%	RMC1/16 104JATP	J24185104		1-	A	B5
R 1385	CHIP RES.	10k	1/16W	5%	RMC1/16 103JATP	J24185103		1-	A	E5
R 1386	CHIP RES.	47k	1/16W	5%	RMC1/16 473JATP	J24185473		1-	A	H4
R 1387	CHIP RES.	100k	1/16W	5%	RMC1/16 104JATP	J24185104		1-	A	D6
R 1388	CHIP RES.	1k	1/16W	5%	RMC1/16 102JATP	J24185102		1-	A	D6
R 1389	CHIP RES.	100k	1/16W	5%	RMC1/16 104JATP	J24185104		1-	A	D6
R 1390	CHIP RES.	100	1/16W	5%	RMC1/16 101JATP	J24185101		1-	A	E6
R 1391	CHIP RES.	0	1/16W	5%	RMC1/16 000JATP	J24185000		1-	A	E3

MAIN Unit

Parts List

REF	DESCRIPTION	VALUE	V/W	TOL.	MFR'S DESIG	VXSTD P/N	VERS.	LOT	SIDE	LAY ADR
R 1392	CHIP RES.	0	1/16W	5%	RMC1/16 000JATP	J24185000		1-	A	F3
R 1393	CHIP RES.	0	1/16W	5%	RMC1/16 000JATP	J24185000		1-	A	F3
R 1394	CHIP RES.	1k	1/16W	5%	RMC1/16 102JATP	J24185102		1-	A	E5
R 1395	CHIP RES.	47k	1/16W	5%	RMC1/16 473JATP	J24185473		1-	A	G3
R 1396	CHIP RES.	100	1/16W	5%	RMC1/16 101JATP	J24185101		1-	A	E4
R 1397	CHIP RES.	47k	1/16W	5%	RMC1/16 473JATP	J24185473		1-	A	B6
R 1398	CHIP RES.	33k	1/16W	5%	RMC1/16 333JATP	J24185333		1-	A	B6
R 1399	CHIP RES.	470	1/10W	5%	RMC1/10T 471J	J24205471		1-	A	A5
R 1400	CHIP RES.	4.7k	1/16W	5%	RMC1/16 472JATP	J24185472		1-	A	D6
R 1401	CHIP RES.	4.7	1/16W	5%	RMC1/16 4R7JATP	J24185479		1-	A	E2
R 1402	CHIP RES.	2.2k	1/16W	5%	RMC1/16 222JATP	J24185222		1-	A	E1
R 1403	CHIP RES.	2.2k	1/16W	5%	RMC1/16 222JATP	J24185222		1-8	A	E5
R 1404	CHIP RES.	330	1/10W	5%	RMC1/10T 331J	J24205331		1-	A	A5
R 1405	CHIP RES.	270	1/16W	5%	RMC1/16 271JATP	J24185271		1-	A	E4
R 1406	CHIP RES.	33k	1/16W	5%	RMC1/16 333JATP	J24185333		1-	A	A5
R 1407	CHIP RES.	470	1/16W	5%	RMC1/16 471JATP	J24185471		1-	A	F5
R 1408	CHIP RES.	330	1/10W	5%	RMC1/10T 331J	J24205331		1-	A	E3
R 1409	CHIP RES.	330	1/10W	5%	RMC1/10T 331J	J24205331		1-	A	F3
R 1410	CHIP RES.	330	1/10W	5%	RMC1/10T 331J	J24205331		1-	A	F3
R 1411	CHIP RES.	150k	1/16W	5%	RMC1/16 154JATP	J24185154		1-	A	F5
R 1412	CHIP RES.	330k	1/16W	5%	RMC1/16 334JATP	J24185334		1-	A	B5
R 1412	CHIP RES.	1M	1/16W	5%	RMC1/16 105JATP	J24185105		7-	A	B5
R 1413	CHIP RES.	47	1/16W	5%	RMC1/16 470JATP	J24185470		1-	A	E4
R 1414	CHIP RES.	22k	1/16W	5%	RMC1/16 223JATP	J24185223		1-	A	A5
R 1415	CHIP RES.	0	1/16W	5%	RMC1/16 000JATP	J24185000		1-	A	E5
R 1416	CHIP RES.	1k	1/16W	5%	RMC1/16 102JATP	J24185102		1-	A	D6
R 1417	CHIP RES.	33k	1/16W	5%	RMC1/16 333JATP	J24185333		1-	A	E1
R 1418	CHIP RES.	470	1/4W	5%	RMC1/4 471JATP	J24245471		1-	A	E4
R 1419	CHIP RES.	3.3k	1/16W	5%	RMC1/16 332JATP	J24185332		1-	A	A5
R 1421	CHIP RES.	10	1/16W	5%	RMC1/16 100JATP	J24185100		1-	A	C4
R 1422	CHIP RES.	47	1/16W	5%	RMC1/16 470JATP	J24185470		1-	A	F5
R 1423	CHIP RES.	0	1/16W	5%	RMC1/16 000JATP	J24185000		1-	A	E5
R 1424	CHIP RES.	330	1/16W	5%	RMC1/16 331JATP	J24185331		1-	A	E1
R 1425	CHIP RES.	33k	1/16W	5%	RMC1/16 333JATP	J24185333		1-	A	C4
R 1426	CHIP RES.	10k	1/16W	5%	RMC1/16 103JATP	J24185103		1-	A	C4
R 1427	CHIP RES.	10k	1/16W	5%	RMC1/16 103JATP	J24185103		1-	A	F5
R 1428	CHIP RES.	470	1/16W	5%	RMC1/16 471JATP	J24185471		1-	A	G1
R 1429	CHIP RES.	1k	1/16W	5%	RMC1/16 102JATP	J24185102		1-	A	B2
R 1430	CHIP RES.	18	1/16W	5%	RMC1/16 180JATP	J24185180		1-	A	E1
R 1431	CHIP RES.	47	1/16W	5%	RMC1/16 470JATP	J24185470		1-	A	E4
R 1432	CHIP RES.	100k	1/16W	5%	RMC1/16 104JATP	J24185104		1-	A	B5
R 1433	CHIP RES.	390	1/16W	5%	RMC1/16 391JATP	J24185391		1-	A	E5
R 1434	CHIP RES.	100	1/16W	5%	RMC1/16 101JATP	J24185101		1-	A	F5
R 1435	CHIP RES.	470	1/16W	5%	RMC1/16 471JATP	J24185471		1-	A	G1
R 1436	CHIP RES.	8.2k	1/16W	5%	RMC1/16 822JATP	J24185822		1-	A	E5
R 1437	CHIP RES.	10k	1/16W	5%	RMC1/16 103JATP	J24185103		1-	A	B5
R 1438	CHIP RES.	220	1/16W	5%	RMC1/16 221JATP	J24185221		1-	A	E5
R 1439	CHIP RES.	22k	1/16W	5%	RMC1/16 223JATP	J24185223		1-	A	B2
R 1440	CHIP RES.	22k	1/16W	5%	RMC1/16 223JATP	J24185223		1-	A	B2
R 1441	CHIP RES.	470	1/16W	5%	RMC1/16 471JATP	J24185471		1-	A	E5
R 1442	CHIP RES.	470	1/16W	5%	RMC1/16 471JATP	J24185471		1-	A	G1
R 1443	CHIP RES.	10k	1/16W	5%	RMC1/16 103JATP	J24185103		1-	A	C5
R 1444	CHIP RES.	100k	1/16W	5%	RMC1/16 104JATP	J24185104		1-	A	E6
R 1445	CHIP RES.	330	1/16W	5%	RMC1/16 331JATP	J24185331		1-	A	E1
R 1446	CHIP RES.	390	1/16W	5%	RMC1/16 391JATP	J24185391		1-	A	E5
R 1447	CHIP RES.	10k	1/16W	5%	RMC1/16 103JATP	J24185103		1-	A	B2
R 1448	CHIP RES.	10k	1/16W	5%	RMC1/16 103JATP	J24185103		1-	A	B2
R 1449	CHIP RES.	33k	1/16W	5%	RMC1/16 333JATP	J24185333		1-	A	C5
R 1450	CHIP RES.	220	1/16W	5%	RMC1/16 221JATP	J24185221		1-	A	C4
R 1451	CHIP RES.	470	1/16W	5%	RMC1/16 471JATP	J24185471		1-	A	F5
R 1452	CHIP RES.	8.2k	1/16W	5%	RMC1/16 822JATP	J24185822		1-	A	F5
R 1453	CHIP RES.	1.8k	1/16W	5%	RMC1/16 182JATP	J24185182		1-	A	E5
R 1454	CHIP RES.	4.7k	1/16W	5%	RMC1/16 472JATP	J24185472		1-	A	E6
R 1455	CHIP RES.	0	1/10W	5%	RMC1/10T 000J	J24205000		1-	A	A5
R 1456	CHIP RES.	1	1W	5%	RMC1 1R0JTE	J24305010		1-	A	A5
R 1457	CHIP RES.	33	1/16W	5%	RMC1/16 330JATP	J24185330		1-	A	F3
R 1458	CHIP RES.	150k	1/16W	5%	RMC1/16 154JATP	J24185154		1-	A	F5
R 1459	CHIP RES.	33k	1/16W	5%	RMC1/16 333JATP	J24185333		1-	A	E5
R 1460	CHIP RES.	220k	1/16W	5%	RMC1/16 224JATP	J24185224		1-	A	B2
R 1461	CHIP RES.	0	1/10W	5%	RMC1/10T 000J	J24205000		1-	A	A5
R 1462	CHIP RES.	820	1/16W	5%	RMC1/16 821JATP	J24185821		1-	A	D5
R 1463	CHIP RES.	33	1/16W	5%	RMC1/16 330JATP	J24185330		1-	A	F3
R 1464	CHIP RES.	10k	1/16W	5%	RMC1/16 103JATP	J24185103		1-	A	D6

MAIN Unit

Parts List

REF	DESCRIPTION	VALUE	V/W	TOL.	MFR'S DESIG	VXSTD P/N	VERS.	LOT	SIDE	LAY ADR
R 1465	CHIP RES.	33	1/16W	5%	RMC1/16 330JATP	J24185330		1-	A	F5
R 1466	CHIP RES.	1.2k	1/16W	5%	RMC1/16 122JATP	J24185122		1-	A	D5
R 1467	CHIP RES.	120k	1/16W	5%	RMC1/16 124JATP	J24185124		1-	A	C5
R 1468	CHIP RES.	33k	1/16W	5%	RMC1/16 333JATP	J24185333		1-	A	C5
R 1469	CHIP RES.	33	1/16W	5%	RMC1/16 330JATP	J24185330		1-	A	F3
R 1470	CHIP RES.	47k	1/16W	5%	RMC1/16 473JATP	J24185473		1-	A	F5
R 1471	CHIP RES.	220k	1/16W	5%	RMC1/16 224JATP	J24185224		1-	A	F5
R 1471	CHIP RES.	100k	1/16W	5%	RMC1/16 104JATP	J24185104		9-	A	F5
R 1472	CHIP RES.	18	1/16W	5%	RMC1/16 180JATP	J24185180		1-	A	F5
R 1473	CHIP RES.	22k	1/16W	5%	RMC1/16 223JATP	J24185223		1-	A	F5
R 1474	CHIP RES.	10k	1/16W	5%	RMC1/16 103JATP	J24185103		1-	A	E5
R 1475	CHIP RES.	10k	1/16W	5%	RMC1/16 103JATP	J24185103		1-	A	C5
R 1476	CHIP RES.	270	1/16W	5%	RMC1/16 271JATP	J24185271		1-	A	E5
R 1477	CHIP RES.	270	1/16W	5%	RMC1/16 271JATP	J24185271		1-	A	E5
R 1478	CHIP RES.	820	1/16W	5%	RMC1/16 821JATP	J24185821		1-	A	D5
R 1479	CHIP RES.	10k	1/16W	5%	RMC1/16 103JATP	J24185103		1-	A	A5
R 1480	CHIP RES.	330	1/10W	5%	RMC1/10T 331J	J24205331		1-	A	F4
R 1481	CHIP RES.	330	1/10W	5%	RMC1/10T 331J	J24205331		1-	A	F4
R 1482	CHIP RES.	330	1/10W	5%	RMC1/10T 331J	J24205331		1-	A	F4
R 1483	CHIP RES.	1.8k	1/16W	5%	RMC1/16 182JATP	J24185182		1-	A	D5
R 1484	CHIP RES.	3.3k	1/16W	5%	RMC1/16 332JATP	J24185332		1-	A	A5
R 1485	CHIP RES.	10k	1/16W	5%	RMC1/16 103JATP	J24185103		1-	A	C5
R 1485	CHIP RES.	3.3k	1/16W	5%	RMC1/16 332JATP	J24185332		13-	A	C5
R 1486	CHIP RES.	470	1/16W	5%	RMC1/16 471JATP	J24185471		1-	A	A5
R 1487	CHIP RES.	10k	1/16W	5%	RMC1/16 103JATP	J24185103		1-	A	F5
R 1487	CHIP RES.	4.7k	1/16W	5%	RMC1/16 472JATP	J24185472		9-	A	F5
R 1488	CHIP RES.	0	1/16W	5%	RMC1/16 000JATP	J24185000		1-	A	C5
R 1489	CHIP RES.	10k	1/16W	5%	RMC1/16 103JATP	J24185103		1-	A	C5
R 1490	CHIP RES.	4.7k	1/16W	5%	RMC1/16 472JATP	J24185472		1-	A	D6
R 1493	CHIP RES.	0	1/16W	5%	RMC1/16 000JATP	J24185000		1-	A	D5
R 1494	CHIP RES.	100	1/4W	5%	RMC1/4 101JATP	J24245101		1-	A	A5
R 1495	CHIP RES.	10k	1/16W	5%	RMC1/16 103JATP	J24185103		1-	A	F5
R 1499	CHIP RES.	10	1/16W	5%	RMC1/16 100JATP	J24185100		1-	A	F5
R 1500	CHIP RES.	680	1/16W	5%	RMC1/16 681JATP	J24185681		1-	A	F5
R 1501	CHIP RES.	680	1/16W	5%	RMC1/16 681JATP	J24185681		1-	A	F5
R 1502	CHIP RES.	47	1/16W	5%	RMC1/16 470JATP	J24185470		1-	A	D5
R 1507	CHIP RES.	4.7k	1/16W	5%	RMC1/16 472JATP	J24185472		1-	A	G5
R 1508	CHIP RES.	10k	1/16W	5%	RMC1/16 103JATP	J24185103		1-	A	C5
R 1510	CHIP RES.	470	1/4W	5%	RMC1/4 471JATP	J24245471		1-	A	D4
R 1511	CHIP RES.	33k	1/16W	5%	RMC1/16 333JATP	J24185333		1-	A	F4
R 1515	CHIP RES.	10k	1/16W	5%	RMC1/16 103JATP	J24185103		1-	A	A6
R 1516	CHIP RES.	10k	1/16W	5%	RMC1/16 103JATP	J24185103		1-	A	F4
R 1517	CHIP RES.	100k	1/16W	5%	RMC1/16 104JATP	J24185104		1-	A	C5
R 1519	CHIP RES.	220k	1/16W	5%	RMC1/16 224JATP	J24185224		1-	A	F5
R 1520	CHIP RES.	100	1/16W	5%	RMC1/16 101JATP	J24185101		1-	A	D5
R 1521	CHIP RES.	330	1/10W	5%	RMC1/10T 331J	J24205331		1-	A	F4
R 1522	CHIP RES.	220	1/16W	5%	RMC1/16 221JATP	J24185221		1-	A	F4
R 1523	CHIP RES.	47	1/16W	5%	RMC1/16 470JATP	J24185470		1-	A	A6
R 1524	CHIP RES.	2.2k	1/16W	5%	RMC1/16 222JATP	J24185222		1-	A	D5
R 1526	CHIP RES.	22k	1/16W	5%	RMC1/16 223JATP	J24185223		1-	A	D5
R 1527	CHIP RES.	100	1/16W	5%	RMC1/16 101JATP	J24185101		1-	A	F4
R 1528	CHIP RES.	68	1/16W	5%	RMC1/16 680JATP	J24185680		1-	A	F4
R 1530	CHIP RES.	22k	1/16W	5%	RMC1/16 223JATP	J24185223		1-	A	D5
R 1531	CHIP RES.	100	1/16W	5%	RMC1/16 101JATP	J24185101		1-	A	C5
R 1532	CHIP RES.	2.2k	1/16W	5%	RMC1/16 222JATP	J24185222		1-	A	C5
R 1533	CHIP RES.	22k	1/16W	5%	RMC1/16 223JATP	J24185223		1-	A	C5
R 1534	CHIP RES.	0	1/16W	5%	RMC1/16 000JATP	J24185000		1-	A	F4
R 1535	CHIP RES.	8.2k	1/16W	5%	RMC1/16 822JATP	J24185822		1-	A	F4
R 1537	CHIP RES.	1k	1/16W	5%	RMC1/16 102JATP	J24185102		1-	A	F5
R 1538	CHIP RES.	150k	1/16W	5%	RMC1/16 154JATP	J24185154		1-	A	F4
R 1539	CHIP RES.	100	1/16W	5%	RMC1/16 101JATP	J24185101		1-	A	F4
R 1540	CHIP RES.	330	1/4W	5%	RMC1/4 331JATP	J24245331		1-	A	A6
R 1541	CHIP RES.	22k	1/16W	5%	RMC1/16 223JATP	J24185223		1-	A	C5
R 1543	CHIP RES.	1k	1/16W	5%	RMC1/16 102JATP	J24185102		1-	A	C5
R 1544	CHIP RES.	100	1/16W	5%	RMC1/16 101JATP	J24185101		1-	A	F5
R 1544	CHIP RES.	10	1/16W	5%	RMC1/16 100JATP	J24185100		12-	A	F5
R 1545	CHIP RES.	0	1/16W	5%	RMC1/16 000JATP	J24185000		1-	A	F5
R 1546	CHIP RES.	220	1/16W	5%	RMC1/16 221JATP	J24185221		1-	A	B6
R 1547	CHIP RES.	1k	1/16W	5%	RMC1/16 102JATP	J24185102		1-	A	B6
R 1548	CHIP RES.	3.9k	1/16W	5%	RMC1/16 392JATP	J24185392		1-	A	G4
R 1549	CHIP RES.	1k	1/16W	5%	RMC1/16 102JATP	J24185102		1-	A	C5
R 1550	CHIP RES.	1k	1/16W	5%	RMC1/16 102JATP	J24185102		1-	A	E3
R 1551	CHIP RES.	1k	1/16W	5%	RMC1/16 102JATP	J24185102		1-	A	B6

MAIN Unit

Parts List

REF	DESCRIPTION	VALUE	V/W	TOL.	MFR'S DESIG	VXSTD P/N	VERS.	LOT	SIDE	LAY ADR
R 1552	CHIP RES.	1k	1/16W	5%	RMC1/16 102JATP	J24185102		1-	A	B5
R 1553	CHIP RES.	1k	1/16W	5%	RMC1/16 102JATP	J24185102		1-	A	B6
R 1554	CHIP RES.	56	1/16W	5%	RMC1/16 560JATP	J24185560		1-	A	H1
R 1555	CHIP RES.	100	1/16W	5%	RMC1/16 101JATP	J24185101		1-	A	F5
R 1556	CHIP RES.	22k	1/16W	5%	RMC1/16 223JATP	J24185223		1-	A	F5
R 1557	CHIP RES.	2.2k	1/16W	5%	RMC1/16 222JATP	J24185222		1-	A	F5
R 1559	CHIP RES.	220k	1/16W	5%	RMC1/16 224JATP	J24185224		1-	A	B2
R 1560	CHIP RES.	0	1/16W	5%	RMC1/16 000JATP	J24185000		1-	A	A1
R 1561	CHIP RES.	0	1/16W	5%	RMC1/16 000JATP	J24185000		1-	A	D6
R 1562	CHIP RES.	0	1/16W	5%	RMC1/16 000JATP	J24185000		1-	A	F6
R 1563	CARBON FILM RES.	1k	1/6W	5%	RD16PJ102 1K	J01225102		9-		
RL1001	RELAY		DC12V		G6K-2F-Y-TR DC12V	M1190183		1-	A	H6
RL1002	RELAY		DC12V		G6K-2F-Y-TR DC12V	M1190183		1-	A	H6
RL1003	RELAY		DC12V		G6K-2F-Y-TR DC12V	M1190183		1-	A	G6
RL1004	RELAY		DC12V		G6K-2F-Y-TR DC12V	M1190183		1-	A	H5
RL1005	RELAY		DC12V		G6K-2F-Y-TR DC12V	M1190183		1-	A	F1
RL1006	RELAY		DC12V		G6K-2F-Y-TR DC12V	M1190183		1-	A	F1
RL1007	RELAY		DC12V		G5V-1 DC12V	M1190120		1-	A	A6
T 1001	BALUN TRANSFORMERS				#458PT-1565	L0190273		1-	A	C1
T 1002	COIL 07WIDE				4-1 2001F FR6	L0021351		1-	A	B1
T 1002	COIL 07WIDE				2001F FR6.3X3.0X2.2	L0021351A		12-	A	B1
T 1003	BALUN TRANSFORMERS				#458PT-1565	L0190273		1-	A	C1
T 1004	BALUN TRANSFORMERS				#458PT-1565	L0190273		1-	A	D2
T 1005	BALUN TRANSFORMERS				#458PT-1565	L0190273		1-	A	D3
T 1006	COIL 05RF				74.62M 010812302	L0022781		1-	A	E3
T 1007	COIL WIDE-TRANS.				3-318707	L0022619		1-	A	F1
T 1008	COIL WIDE-TRANS.				3-318707	L0022619		1-	A	F1
T 1009	COIL 05RF				74.62M 010812302	L0022781		1-	A	D3
T 1010	COIL 05RF				74.62M 010812302	L0022781		1-	A	D3
T 1011	COIL 05RF				100M 010812300A	L0022779		1-	A	F2
T 1012	BALUN TRANSFORMERS				#458PT-1565	L0190273		1-	A	F2
T 1013	BALUN TRANSFORMERS				#617DS-1710	L0190275		1-	A	E2
T 1014	COIL 05RF				74.62M 010812302	L0022781		1-	A	E4
T 1015	BALUN TRANSFORMERS				#458PT-1586	L0190276		1-	A	E2
T 1016	COIL 07WIDE				4-1 2D3 TR6X3	L0020788A		1-	A	D5
T 1017	BALUN TRANSFORMERS				#458PT-1565	L0190273		1-	A	F3
T 1018	COIL 07WIDE				4-1 2D3 TR6X3	L0020788A		1-	A	D5
T 1019	COIL 05RF				74.62M 010812302	L0022781		1-	A	E3
T 1020	BALUN TRANSFORMERS				#617DS-1710	L0190275		1-	A	F3
T 1021	COIL 05RF				100M 010812300A	L0022779		1-	A	E4
T 1022	COIL 05RF	455kHz			455K 030812470	L0022778		1-	A	E5
T 1023	COIL 05RF	455kHz			455K 030812471	L0022780		1-	A	E6
T 1024	COIL 05RF	70MHz			70M 060812606C	L0023009		1-	A	E3
T 1024	COIL 05RF				100M 010812300A	L0022779		13-	A	E3
T 1025	COIL 05RF	70MHz			70M 060812606	L0023011		1-	A	F3
T 1026	COIL 05RF	70MHz			70M 060812606	L0023011		1-	A	F3
T 1027	COIL 05RF	455kHz			455K 030812471	L0022780		1-	A	E5
T 1028	COIL 05RF	455kHz			455K 030812471	L0022780		1-	A	C4
T 1029	COIL 05RF	455kHz			455K 030812471	L0022780		1-	A	F5
T 1030	COIL 05RF	455kHz			455K 060812602	L0023012		1-	A	F5
T 1031	COIL 05RF	70MHz			70M 060812606C	L0023009		1-	A	E4
T 1031	COIL 05RF				100M 010812300A	L0022779		13-	A	E4
T 1032	COIL 05RF	70MHz			70M 060812606	L0023011		1-	A	F4
T 1033	COIL 05RF	70MHz			70M 060812606	L0023011		1-	A	F4
T 1034	COIL 05RF				50M 010812304	L0022783		1-	A	F5
T 1035	BALUN TRANSFORMERS				#458PT-1565	L0190273		1-	A	F5
T 1037	COIL 05RF				74.62M 010812302	L0022781		1-	A	F5
TP1003	CHECK TERMINAL				RCT00000C	Q5000103		1-	A	C1
TP1006	CHECK TERMINAL				RCT00000C	Q5000103		1-	A	C1
TP1035	CHECK TERMINAL				RCT00000C	Q5000103		1-	A	F5
TP1038	CHECK TERMINAL				RCT00000C	Q5000103		1-	A	C4
TP1039	CHECK TERMINAL				RCT00000C	Q5000103		1-	A	C4
TP1041	CHECK TERMINAL				RCT00000C	Q5000103		1-	A	B2
TP1042	CHECK TERMINAL				RCT00000C	Q5000103		1-	A	D3
TP1049	CHECK TERMINAL				RCT00000C	Q5000103		1-	A	E2
TP1050	CHECK TERMINAL				RCT00000C	Q5000103		1-	A	C4
TP1051	CHECK TERMINAL				RCT00000C	Q5000103		1-	A	E3
TP1052	CHECK TERMINAL				RCT00000C	Q5000103		1-	A	C6
TP1055	CHECK TERMINAL				RCT00000C	Q5000103		1-	A	D4
TP1058	CHECK TERMINAL				RCT00000C	Q5000103		1-	A	E5
TP1059	CHECK TERMINAL				RCT00000C	Q5000103		1-	A	F5
TP1063	CHECK TERMINAL				RCT00000C	Q5000103		1-	A	F5
TP1065	CHECK TERMINAL				RCT00000C	Q5000103		1-	A	D4

MAIN Unit

Parts List

REF	DESCRIPTION	VALUE	V/W	TOL.	MFR'S DESIG	VXSTD P/N	VERS.	LOT	SIDE	LAY ADR
XF1001	XTAL FILTER				MFT69Q2 69.450MHZ	H1102404		1-	A	E4
XF1002	XTAL FILTER				MFT69Q2 69.450MHZ	H1102404		1-	A	E3
XF1003	XTAL FILTER				MFT69L3 69.450MHZ	H1102410		1-	A	F3
XF1003	XTAL FILTER				MFT69L4 69.450M	H1102442		16-	A	F3
XF1004	XTAL FILTER				MFT69G2 69.450MHZ	H1102407		1-	A	F3
XF1004	XTAL FILTER				MFT69G3 69.450M	H1102441		15-	A	F3
	SHIELD CASE				(21X25)	RA0830300		1-		
	SHIELD CASE COVER				(21X25)	RA0830400		1-		
	SHIELD CASE				(20X51)	RA0830700		1-		
	SHIELD CASE COVER				(20X51)	RA0830800		1-		
	SHIELD CASE					RA0659300		1-		
	SHIELD CASE				(BPF)	RA0961600		1-		
	SHIELD CASE COVER				(BPF)	RA0961700		1-		

MAIN Unit

Note

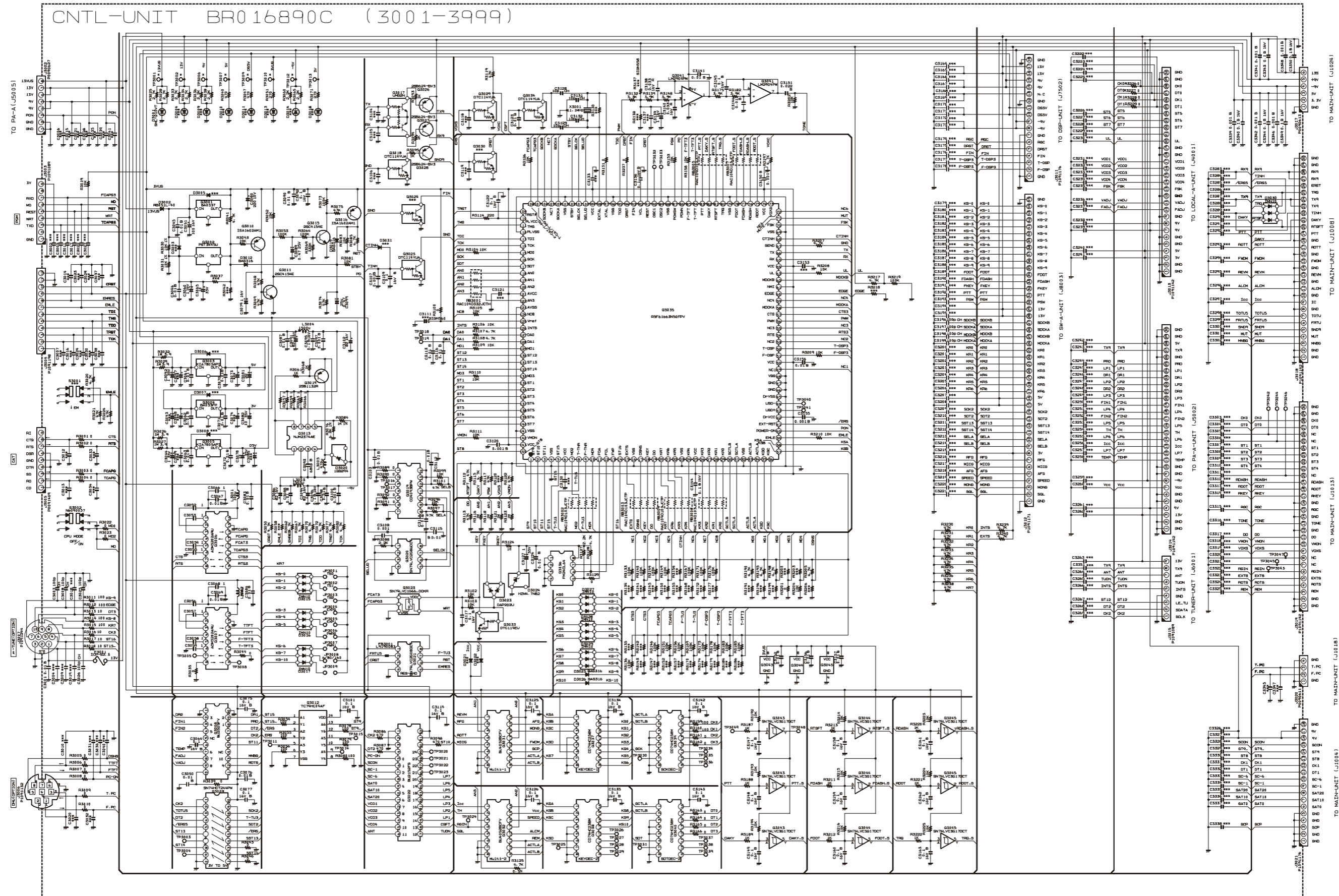

CNTL Unit

Note

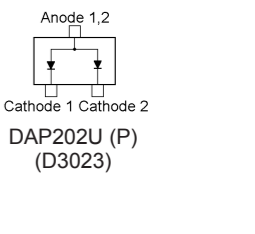
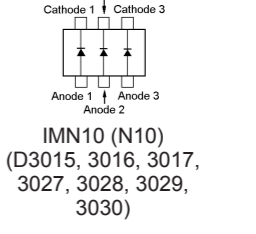
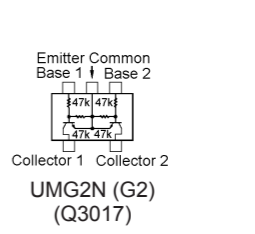
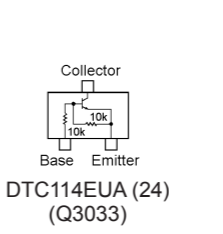
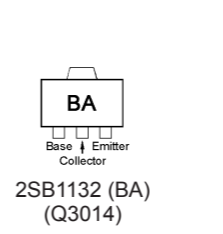
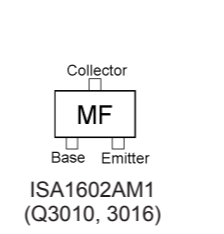
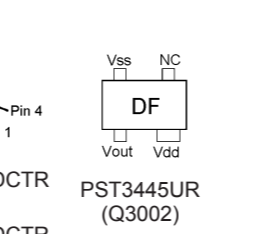
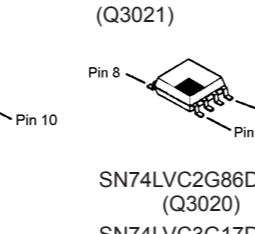
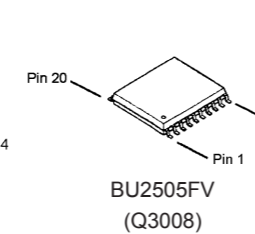
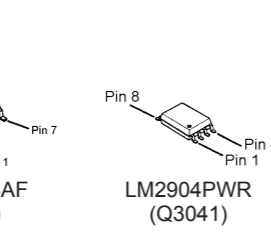
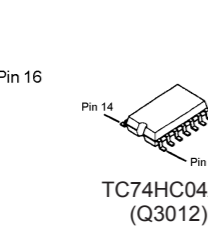
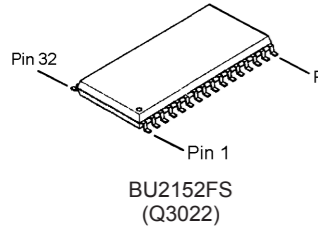
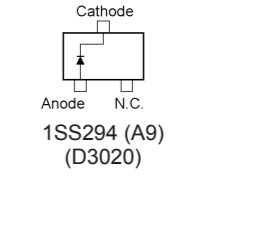
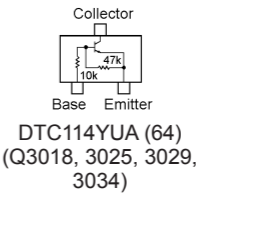
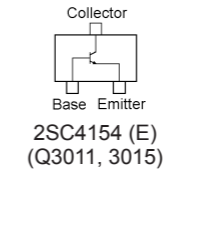
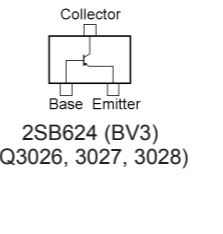
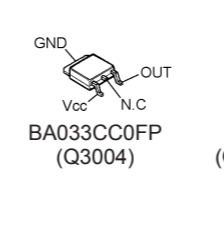
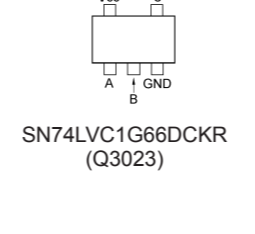
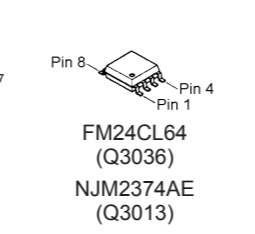
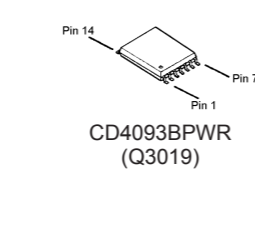
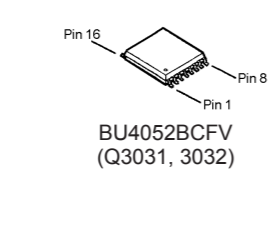
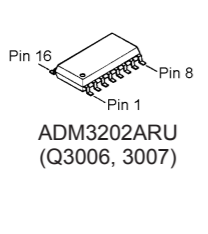
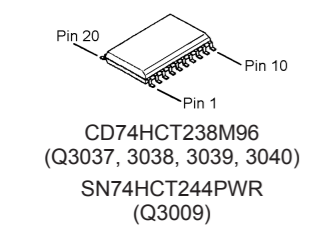
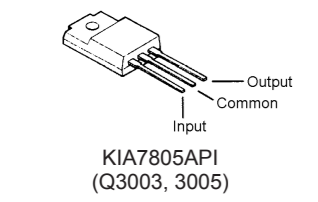
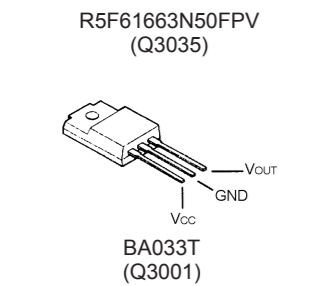
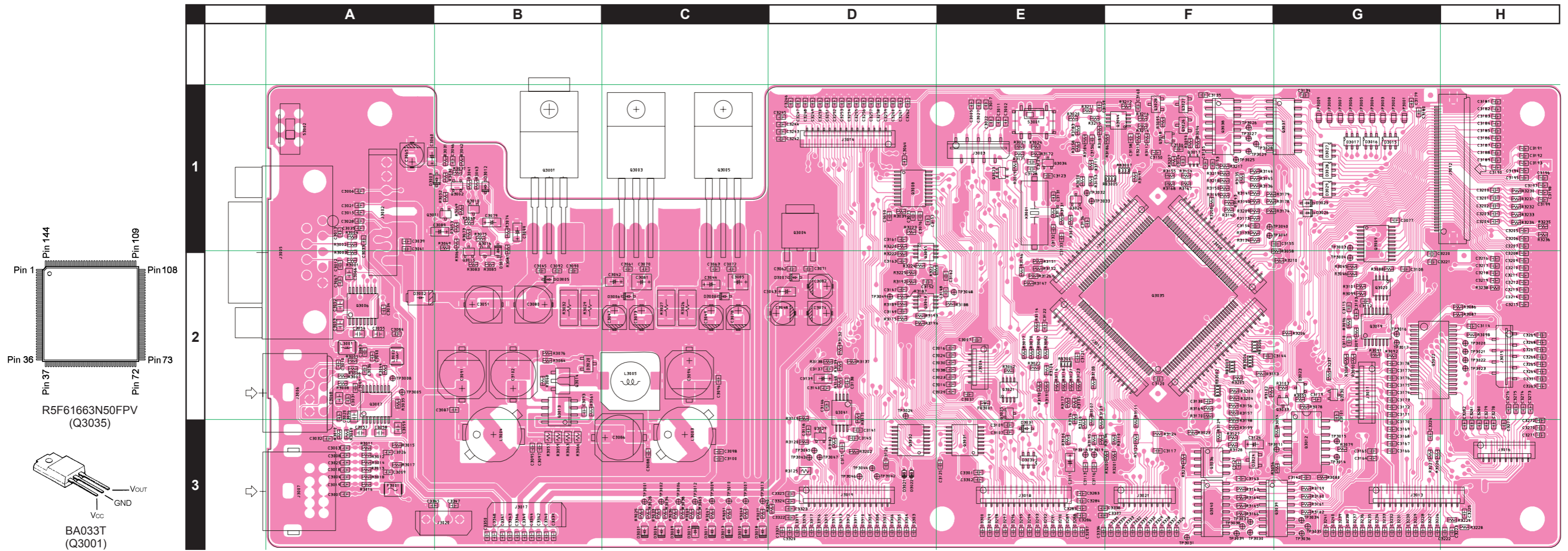

CNTL Unit

Parts Layout (Side B) (Lot. 1~)

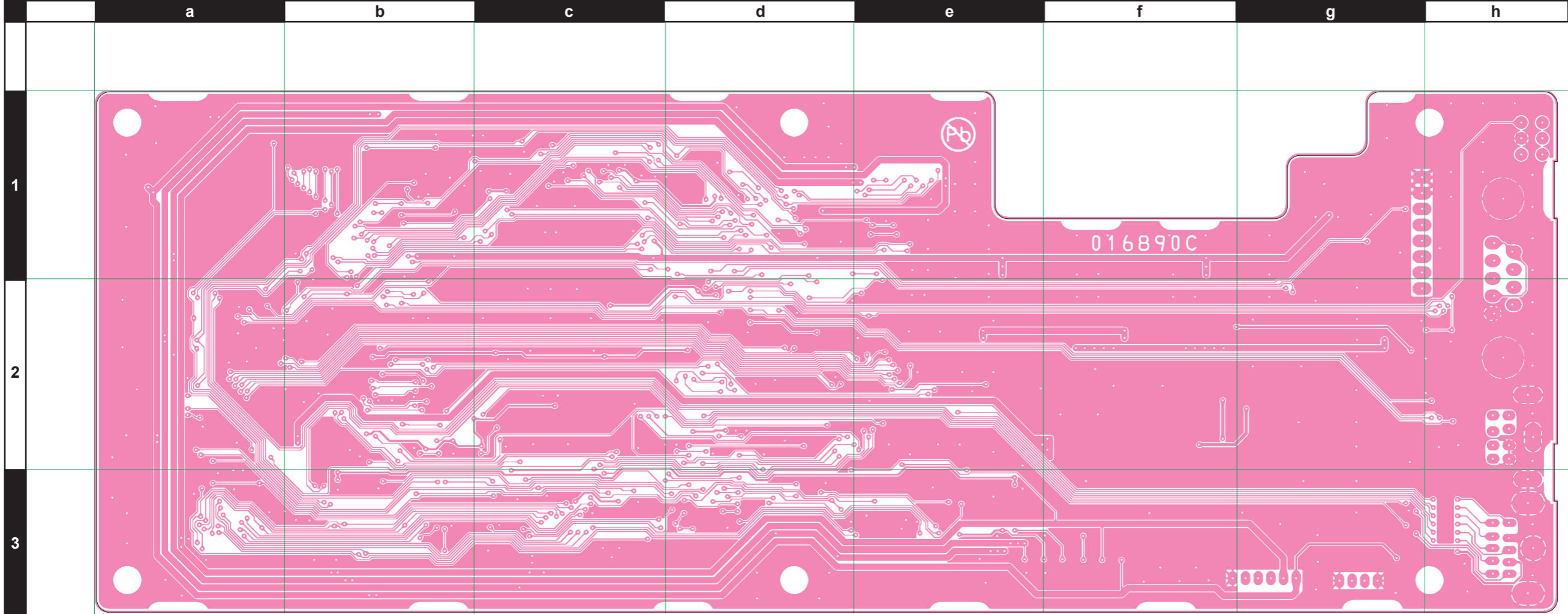

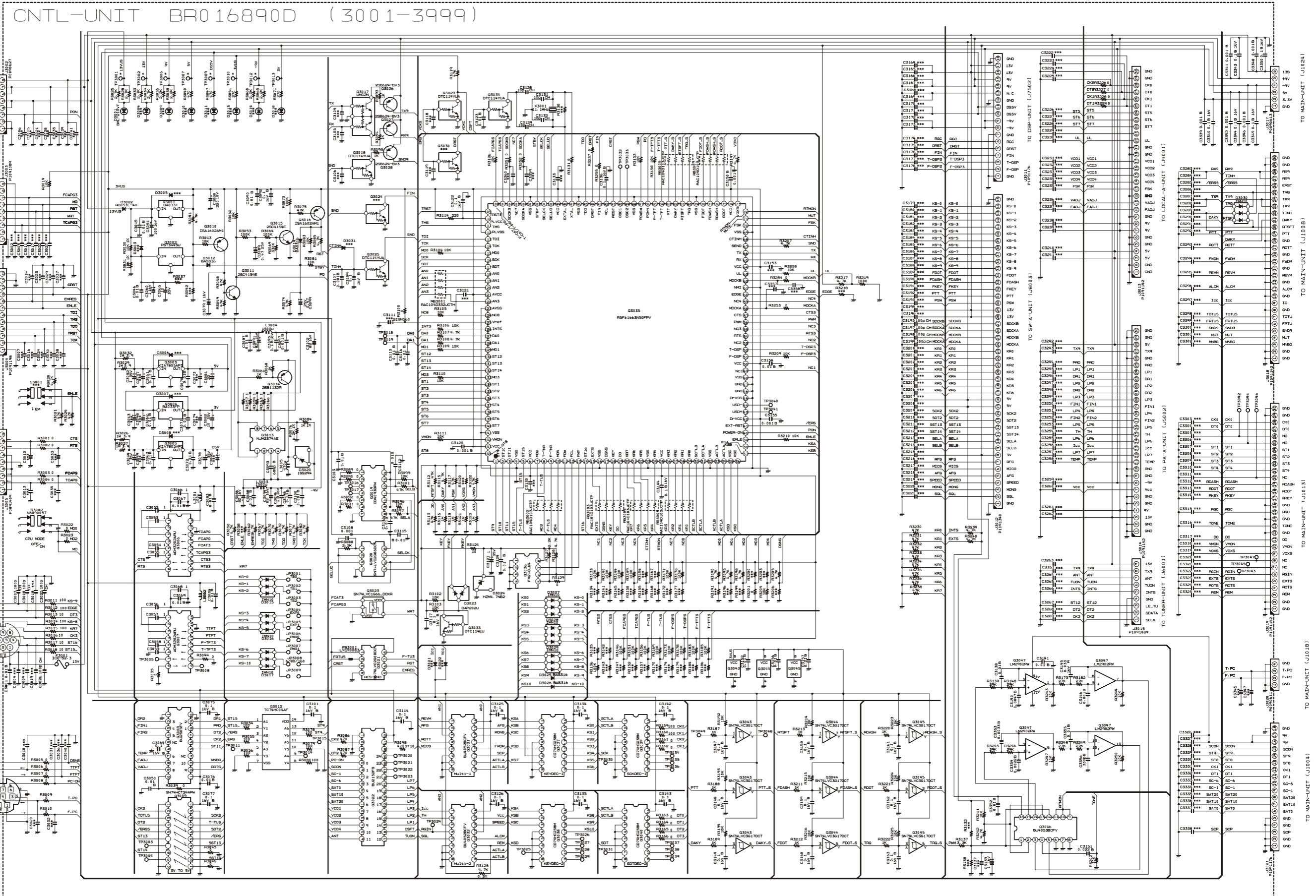

CNTL Unit

Note

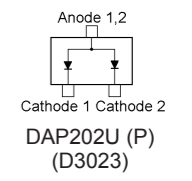
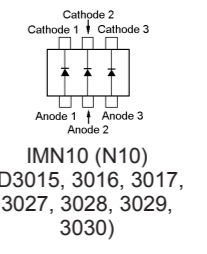
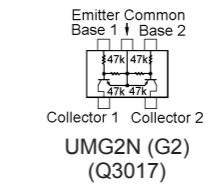
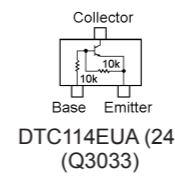
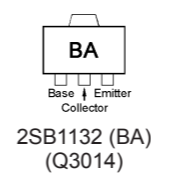
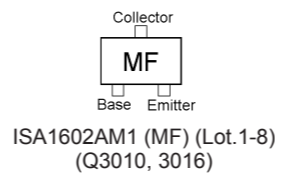
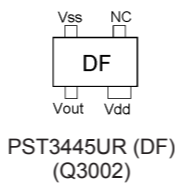
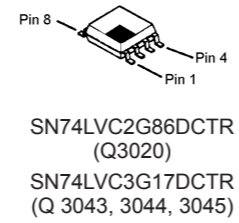
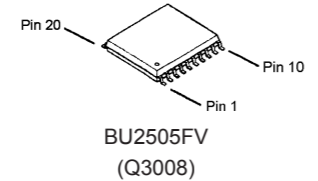
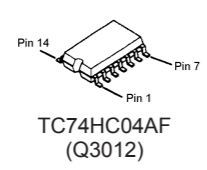
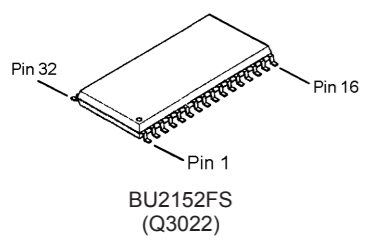
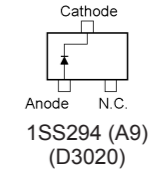
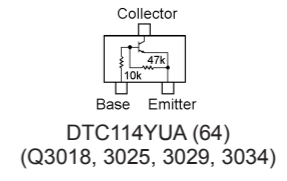
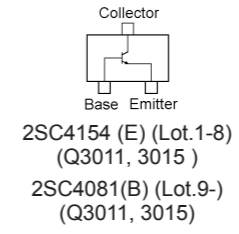
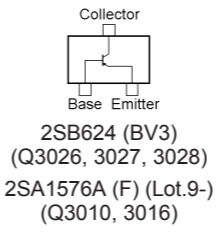
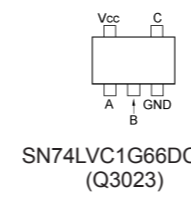
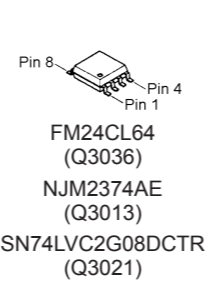
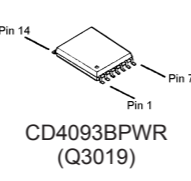
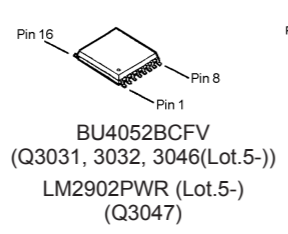
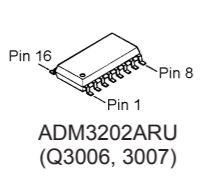
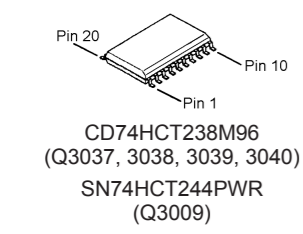
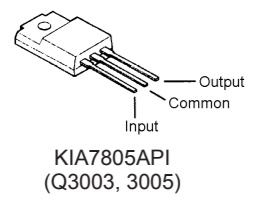
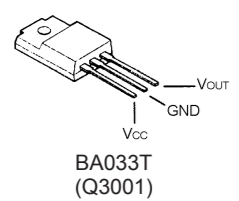
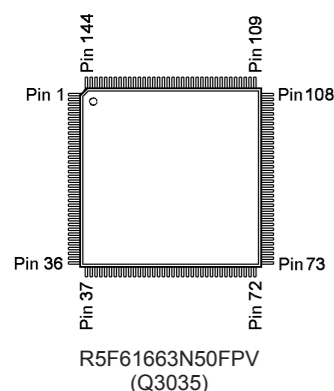
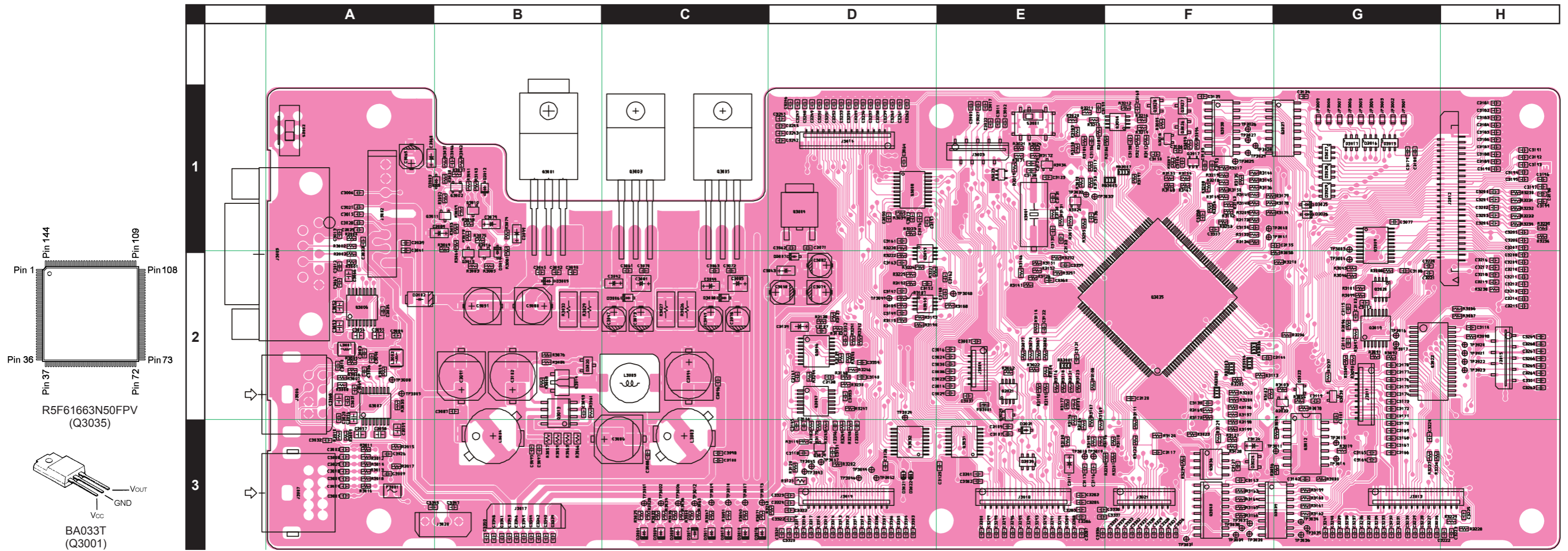

CNTL Unit

Parts Layout (Side B) (Lot. 5~)

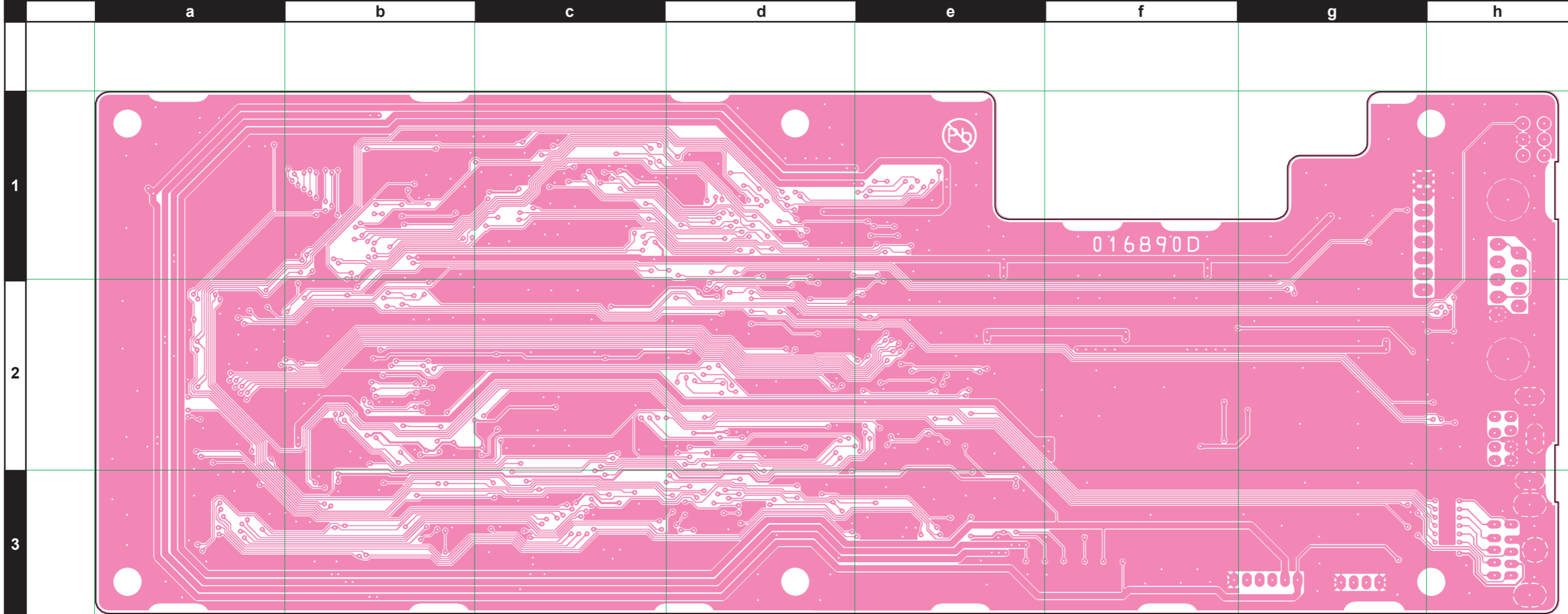

REF	DESCRIPTION	VALUE	V/W	TOL.	MFR'S DESIG	VXSTD P/N	VERS.	LOT	SIDE	LAY ADR
	PCB with Components					CS1964002	USA			
	PCB with Components					CS1964003	EXPORT			
	PCB with Components					CS1964004	EUROPE			
	PCB with Components					CS1964005	UNITED KINGDOM			
	PCB with Components					CS1964006	SPAIN			
	PCB with Components					CS1964007	AUSTRALIA			
	Printed Circuit Board					FR016890C		1-		
	Printed Circuit Board					FR016890D		5-		
C 3001	CHIP CAP.	0.01uF	50V	B	GRM188B11H103KA01D	K22174823		1-	A	A3
C 3003	CHIP CAP.	100pF	50V	CH	GRM1882C1H101JA01D	K22174235		1-	A	A3
C 3008	CHIP CAP.	100pF	50V	CH	GRM1882C1H101JA01D	K22174235		1-	A	A3
C 3025	CHIP CAP.	100pF	50V	CH	GRM1882C1H101JA01D	K22174235		1-	A	A3
C 3026	CHIP CAP.	100pF	50V	CH	GRM1882C1H101JA01D	K22174235		1-	A	A3
C 3042	CHIP TA.CAP.	1uF	35V		TEESVA1V105M8R	K78160032		1-	A	C2
C 3044	CHIP TA.CAP.	1uF	35V		TEESVA1V105M8R	K78160032		1-	A	C2
C 3045	CHIP CAP.	0.01uF	50V	B	GRM188B11H103KA01D	K22174823		1-	A	B2
C 3046	CHIP CAP.	0.01uF	50V	B	GRM188B11H103KA01D	K22174823		1-	A	B1
C 3050	CHIP CAP.	0.01uF	50V	B	GRM188B11H103KA01D	K22174823		1-	A	D1
C 3051	AL.ELECTRO.CAP.	100uF	16V		EEE1CA101WP	K48120012		1-	A	B2
C 3052	CHIP CAP.	1uF	16V	B	GRM21BB11C105KA01L	K22120809		1-	A	A2
C 3053	CHIP CAP.	1uF	16V	B	GRM21BB11C105KA01L	K22120809		1-	A	A2
C 3054	CHIP CAP.	1uF	16V	B	GRM21BB11C105KA01L	K22120809		1-	A	A2
C 3055	CHIP CAP.	1uF	16V	B	GRM21BB11C105KA01L	K22120809		1-	A	A2
C 3056	CHIP CAP.	1uF	16V	B	GRM21BB11C105KA01L	K22120809		1-	A	A2
C 3057	CHIP CAP.	1uF	16V	B	GRM21BB11C105KA01L	K22120809		1-	A	A3
C 3058	CHIP CAP.	1uF	16V	B	GRM21BB11C105KA01L	K22120809		1-	A	A3
C 3059	CHIP CAP.	1uF	16V	B	GRM21BB11C105KA01L	K22120809		1-	A	A3
C 3060	CHIP TA.CAP.	1uF	16V		TEESVA1C105M8R	K78120009		1-	A	A1
C 3061	CHIP CAP.	0.01uF	50V	B	GRM188B11H103KA01D	K22174823		1-	A	C2
C 3062	CHIP CAP.	0.01uF	50V	B	GRM188B11H103KA01D	K22174823		1-	A	D1
C 3063	CHIP CAP.	0.01uF	50V	B	GRM188B11H103KA01D	K22174823		1-	A	C2
C 3064	CHIP CAP.	0.1uF	16V	B	GRM188B11C104KA01D	K22124805		1-	A	D1
C 3065	AL.ELECTRO.CAP.	10uF	35V		EEE1VA100WR	K48160006		1-	A	A1
C 3066	CHIP CAP.	1uF	16V	B	GRM21BB11C105KA01L	K22120809		1-	A	A2
C 3067	CHIP CAP.	0.01uF	50V	B	GRM188B11H103KA01D	K22174823		1-	A	A2
C 3068	CHIP CAP.	1uF	16V	B	GRM21BB11C105KA01L	K22120809		1-	A	A2
C 3069	CHIP CAP.	0.01uF	50V	B	GRM188B11H103KA01D	K22174823		1-	A	A2
C 3070	CHIP CAP.	0.01uF	50V	B	GRM188B11H103KA01D	K22174823		1-	A	C2
C 3071	CHIP CAP.	0.01uF	50V	B	GRM188B11H103KA01D	K22174823		1-	A	D1
C 3072	CHIP CAP.	0.01uF	50V	B	GRM188B11H103KA01D	K22174823		1-	A	C2
C 3075	CHIP CAP.	0.1uF	16V	B	GRM188B11C104KA01D	K22124805		1-	A	D1
C 3076	CHIP CAP.	0.01uF	50V	B	GRM188B11H103KA01D	K22174823		1-	A	D1
C 3077	CHIP CAP.	0.1uF	16V	B	GRM188B11C104KA01D	K22124805		1-	A	G1
C 3078	AL.ELECTRO.CAP.	10uF	35V		EEE1VA100WR	K48160006		1-	A	C2
C 3079	CHIP TA.CAP.	1uF	16V		TEESVA1C105M8R	K78120009		1-	A	B1
C 3080	AL.ELECTRO.CAP.	220uF	10V		EEE1AA221XP	K48100007		1-	A	B2
C 3081	CHIP TA.CAP.	22uF			TPSB226M016Y0600	K78120075		1-	A	C2
C 3082	AL.ELECTRO.CAP.	10uF	35V		EEE1VA100WR	K48160006		1-	A	D2
C 3083	CHIP CAP.	0.01uF	50V	B	GRM188B11H103KA01D	K22174823		1-	A	A2
C 3084	CHIP CAP.	0.01uF	50V	B	GRM188B11H103KA01D	K22174823		1-	A	A2
C 3086	AL.ELECTRO.CAP.	82uF	16V		APXA160ARA820MH70G	K48120022		1-	A	C3
C 3087	CHIP CAP.	0.01uF	50V	B	GRM188B11H103KA01D	K22174823		1-	A	B2
C 3088	CHIP CAP.	0.01uF	50V	B	GRM188B11H103KA01D	K22174823		1-	A	C3
C 3089	CHIP TA.CAP.	0.47uF	25V		TEESVA1E474M8R	K78140009		1-	A	B1
C 3090	CHIP CAP.	0.01uF	50V	B	GRM188B11H103KA01D	K22174823		1-	A	B2
C 3091	AL.ELECTRO.CAP.	82uF	16V		APXA160ARA820MH70G	K48120022		1-	A	B2
C 3092	CHIP CAP.	0.1uF	16V	B	GRM188B11C104KA01D	K22124805		1-	A	B2
C 3093	CHIP CAP.	680pF	50V	B	GRM188B11H681KA01D	K22174807		1-	A	B2
C 3094	AL.ELECTRO.CAP.	82uF	16V		APXA160ARA820MH70G	K48120022		1-	A	C3
C 3095	CHIP CAP.	0.1uF	16V	B	GRM188B11C104KA01D	K22124805		1-	A	B2
C 3096	CHIP CAP.	0.1uF	16V	B	GRM188B11C104KA01D	K22124805		1-	A	C2
C 3097	CHIP CAP.	0.001uF	50V	B	GRM188B11H102KA01D	K22174821		1-	A	B3
C 3098	CHIP CAP.	0.01uF	50V	B	GRM188B11H103KA01D	K22174823		1-	A	C3
C 3099	CHIP TA.CAP.	0.47uF	25V		TEESVA1E474M8R	K78140009		1-	A	B1
C 3100	CHIP CAP.	0.001uF	50V	B	GRM188B11H102KA01D	K22174821		1-	A	C3
C 3101	CHIP CAP.	0.1uF	16V	B	GRM188B11C104KA01D	K22124805		1-	A	G2
C 3102	AL.ELECTRO.CAP.	82uF	16V		APXA160ARA820MH70G	K48120022		1-	A	B2
C 3103	CHIP CAP.	0.01uF	50V	B	GRM188B11H103KA01D	K22174823		1-	A	G2
C 3107	CHIP CAP.	0.001uF	50V	B	GRM188B11H102KA01D	K22174821		1-	A	E3
C 3108	CHIP CAP.	0.001uF	50V	B	GRM188B11H102KA01D	K22174821		1-	A	G2
C 3109	CHIP CAP.	0.1uF	16V	B	GRM188B11C104KA01D	K22124805		1-26	A	E3
C 3110	CHIP CAP.	0.01uF	50V	B	GRM188B11H103KA01D	K22174823		1-	A	G2
C 3112	CHIP CAP.	0.01uF	50V	B	GRM188B11H103KA01D	K22174823		1-	A	G2

CNTL Unit

Parts List

REF	DESCRIPTION	VALUE	V/W	TOL.	MFR'S DESIG	VXSTD P/N	VERS.	LOT	SIDE	LAY ADR
C 3113	CHIP CAP.	0.01uF	50V	B	GRM188B11H103KA01D	K22174823		1-	A	E3
C 3114	CHIP CAP.	0.1uF	16V	B	GRM188B11C104KA01D	K22124805		1-	A	H2
C 3115	CHIP CAP.	0.01uF	50V	B	GRM188B11H103KA01D	K22174823		1-	A	G2
C 3116	CHIP CAP.	0.01uF	50V	B	GRM188B11H103KA01D	K22174823		1-	A	E3
C 3117	CHIP CAP.	0.1uF	16V	B	GRM188B11C104KA01D	K22124805		1-	A	F3
C 3120	CHIP CAP.	0.001uF	50V	B	GRM188B11H102KA01D	K22174821		1-	A	F2
C 3122	CHIP CAP.	0.1uF	16V	B	GRM188B11C104KA01D	K22124805		1-	A	E2
C 3123	CHIP CAP.	0.01uF	50V	B	GRM188B11H103KA01D	K22174823		1-	A	E1
C 3124	CHIP TA.CAP.	1uF	35V		TEESVA1V105M8R	K78160032		1-	A	F3
C 3125	CHIP CAP.	0.1uF	16V	B	GRM188B11C104KA01D	K22124805		1-	A	D3
C 3126	CHIP CAP.	0.1uF	16V	B	GRM188B11C104KA01D	K22124805		1-	A	D3
C 3127	CHIP CAP.	0.01uF	50V	B	GRM188B11H103KA01D	K22174823		1-	A	F3
C 3128	CHIP CAP.	10pF	50V	CH	GRM1882C1H100JA01D	K22174211		1-	A	E1
C 3129	CHIP CAP.	10pF	50V	CH	GRM1882C1H100JA01D	K22174211		1-	A	E1
C 3131	CHIP CAP.	10pF	50V	CH	GRM1882C1H100JA01D	K22174211		1-	A	E1
C 3132	CHIP CAP.	10pF	50V	CH	GRM1882C1H100JA01D	K22174211		1-	A	E1
C 3134	CHIP CAP.	0.1uF	16V	B	GRM188B11C104KA01D	K22124805		1-	A	G1
C 3135	CHIP CAP.	0.1uF	16V	B	GRM188B11C104KA01D	K22124805		1-	A	F1
C 3136	CHIP CAP.	0.1uF	16V	B	GRM188B11C104KA01D	K22124805		1-	A	E1
C 3138	CHIP CAP.	0.033uF	16V	R	GRM188R11C333KA01D	K22124801		1-	A	D2
C 3138	CHIP CAP.	0.01uF	50V	B	GRM188B11H103KA01D	K22174823		5-	A	D2
C 3139	CHIP TA.CAP.	1uF	16V		TEESVA1C105M8R	K78120009		1-	A	D2
C 3140	CHIP CAP.	0.033uF	16V	R	GRM188R11C333KA01D	K22124801		1-	A	D2
C 3140	CHIP CAP.	0.0047uF	50V	B	GRM188B11H472KA01D	K22174833		5-	A	D2
C 3141	CHIP CAP.	0.01uF	50V	B	GRM188B11H103KA01D	K22174823		1-	A	D2
C 3142	CHIP CAP.	0.1uF	16V	B	GRM188B11C104KA01D	K22124805		1-	A	G3
C 3143	CHIP CAP.	0.1uF	16V	B	GRM188B11C104KA01D	K22124805		1-	A	F3
C 3144	CHIP CAP.	0.1uF	16V	B	GRM188B11C104KA01D	K22124805		1-	A	F2
C 3145	CHIP CAP.	0.1uF	16V	B	GRM188B11C104KA01D	K22124805		1-	A	D3
C 3145	CHIP CAP.	0.033uF	16V	R	GRM188R11C333KA01D	K22124801		5-	A	D3
C 3146	CHIP CAP.	0.01uF	50V	B	GRM188B11H103KA01D	K22174823		1-	A	D3
C 3146	CHIP CAP.	0.001uF	50V	B	GRM188B11H102KA01D	K22174821		5-	A	D3
C 3147	CHIP CAP.	0.1uF	16V	B	GRM188B11C104KA01D	K22124805		1-	A	D2
C 3147	CHIP CAP.	0.047uF	25V	B	GRM188B11E473KA01D	K22144811		43-	A	D2
C 3148	CHIP CAP.	0.1uF	16V	B	GRM188B11C104KA01D	K22124805		1-	A	E2
C 3149	CHIP CAP.	0.1uF	16V	B	GRM188B11C104KA01D	K22124805		1-	A	D2
C 3149	CHIP CAP.	0.047uF	25V	B	GRM188B11E473KA01D	K22144811		43-	A	D2
C 3150	CHIP CAP.	0.001uF	50V	B	GRM188B11H102KA01D	K22174821		1-	A	F1
C 3151	CHIP CAP.	0.022uF	50V	B	GRM188B11H223KA01D	K22174839		1-	A	D3
C 3152	CHIP CAP.	0.01uF	50V	B	GRM188B11H103KA01D	K22174823		1-	A	D2
C 3154	CHIP CAP.	0.01uF	50V	B	GRM188B11H103KA01D	K22174823		1-	A	F1
C 3155	CHIP CAP.	0.001uF	50V	B	GRM188B11H102KA01D	K22174821		1-	A	F1
C 3156	CHIP CAP.	0.01uF	50V	B	GRM188B11H103KA01D	K22174823		1-	A	E1
C 3157	CHIP CAP.	0.01uF	50V	B	GRM188B11H103KA01D	K22174823		1-	A	D1
C 3158	CHIP CAP.	0.1uF	16V	B	GRM188B11C104KA01D	K22124805		1-	A	F1
C 3158	CHIP CAP.	0.047uF	25V	B	GRM188B11E473KA01D	K22144811		43-	A	F1
C 3159	CHIP CAP.	0.1uF	16V	B	GRM188B11C104KA01D	K22124805		1-	A	E1
C 3159	CHIP CAP.	0.047uF	25V	B	GRM188B11E473KA01D	K22144811		43-	A	E1
C 3160	CHIP CAP.	0.1uF	16V	B	GRM188B11C104KA01D	K22124805		1-	A	F1
C 3160	CHIP CAP.	0.047uF	25V	B	GRM188B11E473KA01D	K22144811		43-	A	F1
C 3161	CHIP CAP.	0.1uF	16V	B	GRM188B11C104KA01D	K22124805		1-	A	D1
C 3161	CHIP CAP.	0.047uF	25V	B	GRM188B11E473KA01D	K22144811		43-	A	D1
C 3162	CHIP CAP.	0.1uF	16V	B	GRM188B11C104KA01D	K22124805		1-	A	E2
C 3162	CHIP CAP.	0.047uF	25V	B	GRM188B11E473KA01D	K22144811		43-	A	E2
C 3163	CHIP CAP.	0.1uF	16V	B	GRM188B11C104KA01D	K22124805		1-	A	D2
C 3163	CHIP CAP.	0.047uF	25V	B	GRM188B11E473KA01D	K22144811		43-	A	D2
C 3196	CHIP CAP.	100pF	50V	CH	GRM1882C1H101JA01D	K22174235		1-	A	H1
C 3197	CHIP CAP.	100pF	50V	CH	GRM1882C1H101JA01D	K22174235		1-	A	H1
C 3198	CHIP CAP.	100pF	50V	CH	GRM1882C1H101JA01D	K22174235		1-	A	H1
C 3199	CHIP CAP.	100pF	50V	CH	GRM1882C1H101JA01D	K22174235		1-	A	H1
C 3339	CHIP CAP.	0.001uF	50V	B	GRM188B11H102KA01D	K22174821		1-	A	B3
C 3340	CHIP CAP.	0.1uF	16V	B	GRM188B11C104KA01D	K22124805		1-	A	B3
C 3341	CHIP CAP.	0.001uF	50V	B	GRM188B11H102KA01D	K22174821		1-	A	B3
C 3342	CHIP CAP.	0.001uF	50V	B	GRM188B11H102KA01D	K22174821		1-	A	B3
C 3343	CHIP CAP.	0.1uF	16V	B	GRM188B11C104KA01D	K22124805		1-	A	B3
C 3344	CHIP CAP.	0.1uF	16V	B	GRM188B11C104KA01D	K22124805		1-	A	B3
C 3346	CHIP CAP.	0.001uF	50V	B	GRM188B11H102KA01D	K22174821		1-	A	B3
C 3348	CHIP CAP.	0.001uF	50V	B	GRM188B11H102KA01D	K22174821		1-	A	B3
C 3349	CHIP CAP.	0.1uF	16V	B	GRM188B11C104KA01D	K22124805		1-	A	B3
C 3350	CHIP CAP.	0.1uF	16V	B	GRM188B11C104KA01D	K22124805		1-	A	B3
C 3352	CHIP CAP.	0.01uF	50V	B	GRM188B11H103KA01D	K22174823		5-	A	D2
C 3353	CHIP CAP.	0.0033uF	50V	B	GRM188B11H332KA01D	K22174831		5-	A	D2
C 3354	CHIP CAP.	0.0022uF	50V	B	GRM188B11H222KA01D	K22174822		5-	A	D2

REF	DESCRIPTION	VALUE	V/W	TOL.	MFR'S DESIG	VXSTD P/N	VERS.	LOT	SIDE	LAY ADR
C 3355	CHIP CAP.	0.01uF	50V	B	GRM188B11H103KA01D	K22174823		5-	A	D3
C 3356	CHIP CAP.	330pF	50V	B	GRM188B11H331KD01D	K22174803		5-	A	D3
D 3001	LED				SML-210VTT86	G2070768		1-	A	C3
D 3002	DIODE				RB051L-40TE25	G2070718		1-	A	A2
D 3012	DIODE				BAS316	G2070716		1-	A	B1
D 3015	DIODE				IMN10 T108	G2070078		1-	A	G1
D 3016	DIODE				IMN10 T108	G2070078		1-	A	G1
D 3017	DIODE				IMN10 T108	G2070078		1-	A	G1
D 3019	DIODE				BAS316	G2070716		1-	A	B1
D 3020	DIODE				1SS294(TE85R.F)	G2070058		1-	A	B2
D 3023	DIODE				DAP202U T106	G2070160		1-	A	G2
D 3024	DIODE				HZM4.7NB2 TR-E	G2070782		1-	A	F3
D 3025	DIODE				BAS316	G2070716		1-	A	G1
D 3026	DIODE				BAS316	G2070716		1-	A	G1
D 3027	DIODE				IMN10 T108	G2070078		1-	A	G1
D 3028	DIODE				IMN10 T108	G2070078		1-	A	G1
D 3029	DIODE				IMN10 T108	G2070078		1-	A	G1
D 3030	DIODE				IMN10 T108	G2070078		1-	A	E3
F 3001	PROTECTOR				ICP-S2.3TN	G9090144		1-	A	A3
FB3001	FERRITE BEADS				BK1608HS601-T	L9190083		1-	A	E2
J 3002	CONNECTOR				SC25-08WS	P0090627		1-	A	A1
J 3003	CONNECTOR				09FMN-BMTTN-TFT(LF)(SN)	P1091089		1-	A	E1
J 3004	CONNECTOR				12FLT-SM2-TB(LF)(SN)	P1091198		1-	A	E2
J 3005	CONNECTOR				XM2C-0942-232L	P0091409		1-	A	A1
J 3006	CONNECTOR				M50-008-020 R41-9553F	P1091132		1-	A	A2
J 3007	CONNECTOR				TCS7705-5120177	P1091244		1-	A	A3
J 3011	CONNECTOR				18FLT-SM2-TB(LF)(SN)(M)	P1091176		1-	A	G2
J 3012	CONNECTOR				9637S-45-Y905	P1091171		1-	A	H1
J 3012	CONNECTOR				IMSA-9639S-45	P1091340		5-	A	H1
J 3013	CONNECTOR				30FLT-SM2-TB(LF)(SN)(M)	P1091142		1-	A	G3
J 3014	CONNECTOR				30FLT-SM2-TB(LF)(SN)(M)	P1091142		1-	A	D1
J 3015	CONNECTOR				09FMN-BMTTN-TFT(LF)(SN)	P1091089		1-	A	H2
J 3017	CONNECTOR				SB20-06WS	P0090613		1-	A	B3
J 3018	CONNECTOR				30FLT-SM2-TB(LF)(SN)(M)	P1091142		1-	A	E3
J 3019	CONNECTOR				30FLT-SM2-TB(LF)(SN)(M)	P1091142		1-	A	D3
J 3020	CONNECTOR				SB20-04WS	P0090611		1-	A	A3
J 3021	CONNECTOR				18FLT-SM2-TB(LF)(SN)(M)	P1091176		1-	A	F3
JP3001	CHIP RES.	0	1/16W	5%	RMC1/16 000JATP	J24185000		2-	A	G1
JP3002	CHIP RES.	0	1/16W	5%	RMC1/16 000JATP	J24185000		2-	A	G1
JP3003	CHIP RES.	0	1/16W	5%	RMC1/16 000JATP	J24185000		2-	A	G1
JP3006	CHIP RES.	0	1/16W	5%	RMC1/16 000JATP	J24185000		2-	A	G1
JP3007	CHIP RES.	0	1/16W	5%	RMC1/16 000JATP	J24185000		2-	A	G1
L 3001	M.RFC	100uH			FLC32T-101J	L1690227		1-	A	A2
L 3002	M.RFC	100uH			FLC32T-101J	L1690227		1-	A	A2
L 3003	CHIP COIL	1500uH			A814AY-152K=P3	L1691320		1-	A	C3
L 3004	CHIP COIL	1500uH			A814AY-152K=P3	L1691320		1-	A	B3
L 3005	M.RFC	470uH			CDRH105RNP-471NC-VS	L1691359		1-	A	C2
Q 3001	IC				BA033T	G1093776		1-	A	B1
Q 3002	IC				PST3445UR	G1093232		1-	A	B1
Q 3003	IC				KIA7805API	G1093163		1-	A	C1
Q 3004	IC				BA033CC0FP-E2	G1094077		1-	A	D1
Q 3005	IC				KIA7805API	G1093163		1-	A	C1
Q 3006	IC				ADM3202ARU	G1094022		1-	A	A2
Q 3007	IC				ADM3202ARU	G1094022		1-	A	A2
Q 3008	IC				BU2505FV-E2	G1093714		1-	A	D1
Q 3009	IC				SN74HCT244PWR	G1094091		1-	A	G1
Q 3010	TRANSISTOR				ISA1602AM1-T111-1F	G3070380		1-	A	B1
Q 3010	TRANSISTOR				2SA1576A T106 R	G3115768R		9-	A	B1
Q 3011	TRANSISTOR				2SC4154-T111-1E	G3341548E		1-	A	B1
Q 3011	TRANSISTOR				2SC4081 T106	G3340818		9-	A	B1
Q 3012	IC				TC74HC04AF(EL.F)	G1093499		1-	A	G3
Q 3013	IC				NJM2374AE-TE1	G1093808		1-	A	B2
Q 3014	TRANSISTOR				2SB1132 T100 R	G3211327R		1-	A	B2
Q 3015	TRANSISTOR				2SC4154-T111-1E	G3341548E		1-	A	B1
Q 3015	TRANSISTOR				2SC4081 T106	G3340818		9-	A	B1
Q 3016	TRANSISTOR				ISA1602AM1-T111-1F	G3070380		1-	A	B1
Q 3016	TRANSISTOR				2SA1576A T106 R	G3115768R		9-	A	B1
Q 3017	TRANSISTOR				UMG2N TR	G3070088		1-	A	F1
Q 3018	TRANSISTOR				DTC114YUA T106	G3070298		1-	A	F1
Q 3019	IC				CD4093BPWR	G1094093		1-	A	G2
Q 3020	IC				SN74LVC2G86DCTR	G1094486		1-	A	G2
Q 3021	IC				SN74LVC2G08DCTR	G1094341		1-	A	E2
Q 3022	IC				BU2152FS(TAPE)	G1093942		1-	A	G2

CNTL Unit

Parts List

REF	DESCRIPTION	VALUE	V/W	TOL.	MFR'S DESIG	VXSTD P/N	VERS.	LOT	SIDE	LAY ADR
Q 3023	IC				SN74LVC1G66DCKR	G1094046		1-	A	E1
Q 3025	TRANSISTOR				DTC114YUA T106	G3070298		1-	A	E2
Q 3026	TRANSISTOR				2SB624-T2B BV3	G3206247C		1-	A	F1
Q 3027	TRANSISTOR				2SB624-T2B BV3	G3206247C		1-	A	F1
Q 3028	TRANSISTOR				2SB624-T2B BV3	G3206247C		1-	A	F1
Q 3029	TRANSISTOR				DTC114YUA T106	G3070298		1-	A	D3
Q 3031	IC				BU4052BCFV-E2	G1094196		1-	A	E3
Q 3032	IC				BU4052BCFV-E2	G1094196		1-	A	D3
Q 3033	TRANSISTOR				DTC114EUA T106	G3070084		1-	A	G2
Q 3034	TRANSISTOR				DTC114YUA T106	G3070298		1-	A	E1
Q 3035	IC				R5F61663N50FPV			1-	A	F2
Q 3036	IC				FM24CL64	G1094270		1-	A	F3
Q 3037	IC				CD74HC238M96(TAPE)	G1094411		1-	A	G1
Q 3038	IC				CD74HC238M96(TAPE)	G1094411		1-	A	F1
Q 3039	IC				CD74HC238M96(TAPE)	G1094411		1-	A	F3
Q 3040	IC				CD74HC238M96(TAPE)	G1094411		1-	A	F3
Q 3041	IC				LM2904PWR	G1094010		1-4		
Q 3043	IC				SN74LVC3G17DCTR	G1094419		1-	A	D2
Q 3044	IC				SN74LVC3G17DCTR	G1094419		1-	A	F1
Q 3045	IC				SN74LVC3G17DCTR	G1094419		1-	A	D1
Q 3046	IC				BU4053BCFV-E2	G1093422		5-	A	D2
Q 3047	IC				LM2902PWR	G1094009		5-	A	D2
R 3001	CHIP RES.	0	1/16W	5%	RMC1/16 000JATP	J24185000		1-	A	A2
R 3002	CHIP RES.	0	1/16W	5%	RMC1/16 000JATP	J24185000		1-	A	A1
R 3003	CHIP RES.	0	1/16W	5%	RMC1/16 000JATP	J24185000		1-	A	A1
R 3004	CHIP RES.	0	1/16W	5%	RMC1/16 000JATP	J24185000		1-	A	A1
R 3005	CHIP RES.	0	1/16W	5%	RMC1/16 000JATP	J24185000		1-	A	A2
R 3006	CHIP RES.	0	1/16W	5%	RMC1/16 000JATP	J24185000		1-	A	A2
R 3007	CHIP RES.	0	1/16W	5%	RMC1/16 000JATP	J24185000		1-	A	A2
R 3008	CHIP RES.	0	1/16W	5%	RMC1/16 000JATP	J24185000		1-	A	A2
R 3009	CHIP RES.	0	1/16W	5%	RMC1/16 000JATP	J24185000		1-	A	A3
R 3010	CHIP RES.	0	1/16W	5%	RMC1/16 000JATP	J24185000		1-	A	A3
R 3011	CHIP RES.	100	1/16W	5%	RMC1/16 101JATP	J24185101		1-	A	A3
R 3012	CHIP RES.	100	1/16W	5%	RMC1/16 101JATP	J24185101		1-	A	A3
R 3013	CHIP RES.	10	1/16W	5%	RMC1/16 100JATP	J24185100		1-	A	A3
R 3014	CHIP RES.	100	1/16W	5%	RMC1/16 101JATP	J24185101		1-	A	A3
R 3015	CHIP RES.	100	1/16W	5%	RMC1/16 101JATP	J24185101		1-	A	A3
R 3016	CHIP RES.	10	1/16W	5%	RMC1/16 100JATP	J24185100		1-	A	A3
R 3017	CHIP RES.	10	1/16W	5%	RMC1/16 100JATP	J24185100		1-	A	A3
R 3018	CHIP RES.	10	1/16W	5%	RMC1/16 100JATP	J24185100		1-	A	A3
R 3019	CHIP RES.	10k	1/16W	5%	RMC1/16 103JATP	J24185103		1-	A	E1
R 3020	CHIP RES.	4.7k	1/16W	5%	RMC1/16 472JATP	J24185472		1-	A	E1
R 3021	CHIP RES.	47k	1/16W	5%	RMC1/16 473JATP	J24185473		1-	A	E1
R 3022	CHIP RES.	0	1/16W	5%	RMC1/16 000JATP	J24185000		1-	A	E2
R 3023	CHIP RES.	0	1/16W	5%	RMC1/16 000JATP	J24185000		1-	A	F3
R 3024	CHIP RES.	47k	1/16W	5%	RMC1/16 473JATP	J24185473		1-	A	E1
R 3025	CHIP RES.	2.7k	1/16W	5%	RMC1/16 272JATP	J24185272		1-	A	C3
R 3026	CHIP RES.	3.9	1W	5%	RMC1 3R9JTE	J24305399		1-	A	C2
R 3027	CHIP RES.	3.9	1W	5%	RMC1 3R9JTE	J24305399		1-	A	C2
R 3028	CHIP RES.	2.7k	1/16W	5%	RMC1/16 272JATP	J24185272		1-	A	C3
R 3029	CHIP RES.	3.9	1W	5%	RMC1 3R9JTE	J24305399		1-	A	B2
R 3030	CHIP RES.	10k	1/16W	1%	RMC1/16 103FTP	J24183103		1-	A	B1
R 3031	CHIP RES.	10k	1/16W	1%	RMC1/16 103FTP	J24183103		1-	A	B1
R 3032	CHIP RES.	3.9	1W	5%	RMC1 3R9JTE	J24305399		1-	A	B2
R 3033	CHIP RES.	2.7k	1/16W	5%	RMC1/16 272JATP	J24185272		1-	A	C3
R 3034	CHIP RES.	2.7k	1/16W	5%	RMC1/16 272JATP	J24185272		1-	A	C3
R 3035	CHIP RES.	0	1/16W	5%	RMC1/16 000JATP	J24185000		1-	A	A2
R 3036	CHIP RES.	2.2k	1/16W	5%	RMC1/16 222JATP	J24185222		1-	A	C3
R 3038	CHIP RES.	2.2k	1/16W	5%	RMC1/16 222JATP	J24185222		1-	A	C3
R 3039	CHIP RES.	0	1/16W	5%	RMC1/16 000JATP	J24185000		1-	A	D1
R 3040	CHIP RES.	470	1/16W	5%	RMC1/16 471JATP	J24185471		1-	A	C3
R 3041	CHIP RES.	4.7k	1/16W	5%	RMC1/16 472JATP	J24185472		1-	A	B1
R 3043	CHIP RES.	10k	1/16W	5%	RMC1/16 103JATP	J24185103		1-	A	B1
R 3044	CHIP RES.	0	1/16W	5%	RMC1/16 000JATP	J24185000		1-	A	A2
R 3045	CHIP RES.	0	1/16W	5%	RMC1/16 000JATP	J24185000		1-	A	G2
R 3046	CHIP RES.	0	1/16W	5%	RMC1/16 000JATP	J24185000		1-	A	G2
R 3047	CHIP RES.	470	1/16W	5%	RMC1/16 471JATP	J24185471		1-	A	C3
R 3048	CHIP RES.	47k	1/16W	5%	RMC1/16 473JATP	J24185473		1-	A	B1
R 3049	CHIP RES.	47k	1/16W	5%	RMC1/16 473JATP	J24185473		1-	A	B1
R 3050	CHIP RES.	4.7k	1/16W	5%	RMC1/16 472JATP	J24185472		1-	A	E1
R 3051	CHIP RES.	270	1/16W	5%	RMC1/16 271JATP	J24185271		1-	A	C3
R 3052	CHIP RES.	10k	1/16W	5%	RMC1/16 103JATP	J24185103		1-	A	B1
R 3053	CHIP RES.	100k	1/16W	5%	RMC1/16 104JATP	J24185104		1-	A	B1

CNTL Unit

Parts List

REF	DESCRIPTION	VALUE	V/W	TOL.	MFR'S DESIG	VXSTD P/N	VERS.	LOT	SIDE	LAY ADR
R 3054	CHIP RES.	100	1/16W	5%	RMC1/16 101JATP	J24185101		1-	A	F3
R 3055	CHIP RES.	100	1/16W	5%	RMC1/16 101JATP	J24185101		1-	A	G2
R 3056	CHIP RES.	100	1/16W	5%	RMC1/16 101JATP	J24185101		1-	A	F3
R 3057	CHIP RES.	1	1/10W	5%	RMC1/10T 1R0J	J24205010		1-	A	B3
R 3059	CHIP RES.	1	1/10W	5%	RMC1/10T 1R0J	J24205010		1-	A	B3
R 3060	CHIP RES.	2.2k	1/16W	5%	RMC1/16 222JATP	J24185222		1-	A	C3
R 3061	CHIP RES.	1k	1/16W	5%	RMC1/16 102JATP	J24185102		1-	A	B2
R 3062	CHIP RES.	4.7k	1/16W	5%	RMC1/16 472JATP	J24185472		1-	A	E2
R 3063	CHIP RES.	1	1/10W	5%	RMC1/10T 1R0J	J24205010		1-	A	B3
R 3064	CHIP RES.	100k	1/16W	5%	RMC1/16 104JATP	J24185104		1-	A	B1
R 3065	CHIP RES.	2.2k	1/16W	5%	RMC1/16 222JATP	J24185222		1-	A	C3
R 3066	CHIP RES.	1	1/10W	5%	RMC1/10T 1R0J	J24205010		1-	A	B3
R 3067	CHIP RES.	4.7k	1/16W	5%	RMC1/16 472JATP	J24185472		1-	A	E2
R 3068	CHIP RES.	1k	1/16W	5%	RMC1/16 102JATP	J24185102		1-	A	B2
R 3069	CHIP RES.	330k	1/16W	5%	RMC1/16 334JATP	J24185334		1-	A	B1
R 3070	CHIP RES.	4.7k	1/16W	5%	RMC1/16 472JATP	J24185472		1-	A	E2
R 3071	CHIP RES.	270	1/16W	5%	RMC1/16 271JATP	J24185271		1-	A	C3
R 3072	CHIP RES.	4.7k	1/16W	5%	RMC1/16 472JATP	J24185472		1-	A	E1
R 3073	CHIP RES.	100k	1/16W	5%	RMC1/16 104JATP	J24185104		1-	A	B1
R 3074	CHIP RES.	47k	1/16W	5%	RMC1/16 473JATP	J24185473		1-	A	B1
R 3075	CHIP RES.	47k	1/16W	5%	RMC1/16 473JATP	J24185473		1-	A	B1
R 3076	CHIP RES.	6.2k	1/16W	1%	RMC1/16 622FTP	J24183622		1-	A	B2
R 3077	CHIP RES.	4.7k	1/16W	5%	RMC1/16 472JATP	J24185472		1-	A	E2
R 3078	CHIP RES.	100	1/16W	5%	RMC1/16 101JATP	J24185101		1-	A	G2
R 3079	CHIP RES.	100	1/16W	5%	RMC1/16 101JATP	J24185101		1-	A	G3
R 3080	CHIP RES.	100	1/16W	5%	RMC1/16 101JATP	J24185101		1-	A	G3
R 3081	CHIP RES.	10k	1/16W	5%	RMC1/16 103JATP	J24185103		1-	A	B1
R 3082	CHIP RES.	4.7k	1/16W	5%	RMC1/16 472JATP	J24185472		1-	A	E2
R 3083	CHIP RES.	10k	1/16W	5%	RMC1/16 103JATP	J24185103		1-	A	B2
R 3084	CHIP RES.	1k	1/16W	1%	RMC1/16 102FTP	J24183102		1-	A	B2
R 3085	CHIP RES.	4.7k	1/16W	5%	RMC1/16 472JATP	J24185472		1-	A	B2
R 3086	CHIP RES.	470	1/16W	5%	RMC1/16 471JATP	J24185471		1-	A	H2
R 3087	CHIP RES.	470	1/16W	5%	RMC1/16 471JATP	J24185471		1-	A	H2
R 3088	CHIP RES.	2.2k	1/16W	5%	RMC1/16 222JATP	J24185222		1-	A	G2
R 3089	CHIP RES.	0	1/16W	5%	RMC1/16 000JATP	J24185000		1-	A	G2
R 3090	CHIP RES.	0	1/16W	5%	RMC1/16 000JATP	J24185000		1-	A	G2
R 3091	CHIP RES.	0	1/16W	5%	RMC1/16 000JATP	J24185000		1-	A	G2
R 3092	CHIP RES.	0	1/16W	5%	RMC1/16 000JATP	J24185000		1-	A	G2
R 3093	CHIP RES.	1k	1/16W	5%	RMC1/16 102JATP	J24185102		1-	A	F1
R 3094	CHIP RES.	1k	1/16W	5%	RMC1/16 102JATP	J24185102		1-	A	F1
R 3095	CHIP RES.	1k	1/16W	5%	RMC1/16 102JATP	J24185102		1-	A	F1
R 3096	CHIP RES.	10k	1/16W	5%	RMC1/16 103JATP	J24185103		1-	A	G2
R 3097	CHIP RES.	47k	1/16W	5%	RMC1/16 473JATP	J24185473		1-	A	G2
R 3098	CHIP RES.	470	1/16W	5%	RMC1/16 471JATP	J24185471		1-	A	H2
R 3099	CHIP RES.	10k	1/16W	5%	RMC1/16 103JATP	J24185103		1-	A	G2
R 3100	CHIP RES.	0	1/16W	5%	RMC1/16 000JATP	J24185000		1-	A	E3
R 3101	CHIP RES.	47k	1/16W	5%	RMC1/16 473JATP	J24185473		1-	A	G2
R 3102	CHIP RES.	10k	1/16W	5%	RMC1/16 103JATP	J24185103		1-	A	F2
R 3103	CHIP RES.	10k	1/16W	5%	RMC1/16 103JATP	J24185103		1-	A	G2
R 3104	CHIP RES.	10k	1/16W	5%	RMC1/16 103JATP	J24185103		1-	A	E2
R 3105	CHIP RES.	10k	1/16W	5%	RMC1/16 103JATP	J24185103		1-	A	E2
R 3106	CHIP RES.	10k	1/16W	5%	RMC1/16 103JATP	J24185103		1-	A	E2
R 3107	CHIP RES.	4.7k	1/16W	5%	RMC1/16 472JATP	J24185472		1-	A	E2
R 3108	CHIP RES.	4.7k	1/16W	5%	RMC1/16 472JATP	J24185472		1-	A	E2
R 3109	CHIP RES.	10k	1/16W	5%	RMC1/16 103JATP	J24185103		1-	A	E2
R 3110	CHIP RES.	10k	1/16W	5%	RMC1/16 103JATP	J24185103		1-	A	F3
R 3111	CHIP RES.	10k	1/16W	5%	RMC1/16 103JATP	J24185103		1-	A	F2
R 3112	CHIP RES.	47k	1/16W	5%	RMC1/16 473JATP	J24185473		1-	A	F1
R 3113	CHIP RES.	47k	1/16W	5%	RMC1/16 473JATP	J24185473		1-	A	F2
R 3114	CHIP RES.	220	1/16W	5%	RMC1/16 221JATP	J24185221		1-	A	E2
R 3115	CHIP RES.	4.7k	1/16W	5%	RMC1/16 472JATP	J24185472		1-	A	D2
R 3116	CHIP RES.	1M	1/16W	5%	RMC1/16 105JATP	J24185105		1-	A	E2
R 3117	CHIP RES.	47k	1/16W	5%	RMC1/16 473JATP	J24185473		1-	A	E1
R 3118	CHIP RES.	1M	1/16W	5%	RMC1/16 105JATP	J24185105		1-	A	E2
R 3119	CHIP RES.	47k	1/16W	5%	RMC1/16 473JATP	J24185473		1-	A	D3
R 3121	CHIP RES.	1M	1/16W	5%	RMC1/16 105JATP	J24185105		1-	A	E2
R 3122	CHIP RES.	47k	1/16W	5%	RMC1/16 473JATP	J24185473		1-	A	F3
R 3123	CHIP RES.	1M	1/16W	5%	RMC1/16 105JATP	J24185105		1-	A	E2
R 3124	CHIP RES.	10	1/16W	5%	RMC1/16 100JATP	J24185100		1-	A	F3
R 3125	CHIP RES.	4.7k	1/10W	0.5%	RR1220P-472-D-T5	J24209187		1-	A	D3
R 3126	CHIP RES.	10k	1/16W	5%	RMC1/16 103JATP	J24185103		1-	A	E2
R 3127	CHIP RES.	2.2k	1/16W	5%	RMC1/16 222JATP	J24185222		1-	A	F3
R 3128	CHIP RES.	4.7k	1/16W	5%	RMC1/16 472JATP	J24185472		1-	A	F3

CNTL Unit

Parts List

REF	DESCRIPTION	VALUE	V/W	TOL.	MFR'S DESIG	VXSTD P/N	VERS.	LOT	SIDE	LAY ADR
R 3129	CHIP RES.	0	1/16W	5%	RMC1/16 000JATP	J24185000		1-	A	F3
R 3131	CHIP RES.	0	1/16W	5%	RMC1/16 000JATP	J24185000		1-	A	E1
R 3132	CHIP RES.	3.3k	1/16W	5%	RMC1/16 332JATP	J24185332		1-4	A	D2
R 3133	CHIP RES.	100k	1/16W	5%	RMC1/16 104JATP	J24185104		1-	A	F1
R 3136	CHIP RES.	100k	1/16W	5%	RMC1/16 104JATP	J24185104		1-	A	F1
R 3137	CHIP RES.	3.3k	1/16W	5%	RMC1/16 332JATP	J24185332		5-	A	D2
R 3139	CHIP RES.	3.9k	1/16W	5%	RMC1/16 392JATP	J24185392		1-	A	D2
R 3139	CHIP RES.	39k	1/16W	5%	RMC1/16 393JATP	J24185393		5-	A	D2
R 3140	CHIP RES.	100k	1/16W	5%	RMC1/16 104JATP	J24185104		1-	A	F1
R 3144	CHIP RES.	100k	1/16W	5%	RMC1/16 104JATP	J24185104		1-	A	F1
R 3146	CHIP RES.	100k	1/16W	5%	RMC1/16 104JATP	J24185104		1-	A	E2
R 3148	CHIP RES.	3.9k	1/16W	5%	RMC1/16 392JATP	J24185392		1-	A	D2
R 3148	CHIP RES.	39k	1/16W	5%	RMC1/16 393JATP	J24185393		5-	A	D2
R 3149	CHIP RES.	100k	1/16W	5%	RMC1/16 104JATP	J24185104		1-	A	F1
R 3151	CHIP RES.	100k	1/16W	5%	RMC1/16 104JATP	J24185104		1-	A	E2
R 3153	CHIP RES.	10k	1/16W	5%	RMC1/16 103JATP	J24185103		1-	A	E1
R 3156	CHIP RES.	100k	1/16W	5%	RMC1/16 104JATP	J24185104		1-	A	F2
R 3158	CHIP RES.	10k	1/16W	5%	RMC1/16 103JATP	J24185103		1-	A	E1
R 3159	CHIP RES.	100	1/16W	5%	RMC1/16 101JATP	J24185101		1-	A	G3
R 3160	CHIP RES.	100	1/16W	5%	RMC1/16 101JATP	J24185101		1-	A	G3
R 3161	CHIP RES.	0	1/16W	5%	RMC1/16 000JATP	J24185000		1-	A	G3
R 3162	CHIP RES.	0	1/16W	5%	RMC1/16 000JATP	J24185000		1-	A	G3
R 3163	CHIP RES.	0	1/16W	5%	RMC1/16 000JATP	J24185000		1-	A	F3
R 3164	CHIP RES.	0	1/16W	5%	RMC1/16 000JATP	J24185000		1-	A	F3
R 3165	CHIP RES.	0	1/16W	5%	RMC1/16 000JATP	J24185000		1-	A	F3
R 3166	CHIP RES.	0	1/16W	5%	RMC1/16 000JATP	J24185000		1-	A	F3
R 3167	CHIP RES.	100k	1/16W	5%	RMC1/16 104JATP	J24185104		1-4	A	F1
R 3169	CHIP RES.	100k	1/16W	5%	RMC1/16 104JATP	J24185104		1-	A	F2
R 3171	CHIP RES.	100k	1/16W	5%	RMC1/16 104JATP	J24185104		1-	A	E1
R 3173	CHIP RES.	100k	1/16W	5%	RMC1/16 104JATP	J24185104		1-	A	F1
R 3175	CHIP RES.	3.9k	1/16W	5%	RMC1/16 392JATP	J24185392		1-	A	D3
R 3175	CHIP RES.	27k	1/16W	5%	RMC1/16 273JATP	J24185273		5-	A	D3
R 3176	CHIP RES.	100k	1/16W	5%	RMC1/16 104JATP	J24185104		1-	A	E2
R 3178	CHIP RES.	100k	1/16W	5%	RMC1/16 104JATP	J24185104		1-	A	F1
R 3182	CHIP RES.	3.9k	1/16W	5%	RMC1/16 392JATP	J24185392		1-	A	D3
R 3182	CHIP RES.	27k	1/16W	5%	RMC1/16 273JATP	J24185273		5-	A	D3
R 3183	CHIP RES.	100k	1/16W	5%	RMC1/16 104JATP	J24185104		1-	A	E1
R 3185	CHIP RES.	100k	1/16W	5%	RMC1/16 104JATP	J24185104		1-	A	E1
R 3187	CHIP RES.	1k	1/16W	5%	RMC1/16 102JATP	J24185102		1-	A	D2
R 3188	CHIP RES.	1k	1/16W	5%	RMC1/16 102JATP	J24185102		1-	A	E2
R 3188	CHIP RES.	0	1/16W	5%	RMC1/16 000JATP	J24185000		7-	A	E2
R 3189	CHIP RES.	1k	1/16W	5%	RMC1/16 102JATP	J24185102		1-	A	D2
R 3190	CHIP RES.	4.7k	1/16W	5%	RMC1/16 472JATP	J24185472		1-	A	E2
R 3192	CHIP RES.	10k	1/16W	5%	RMC1/16 103JATP	J24185103		1-	A	D2
R 3192	CHIP RES.	47k	1/16W	5%	RMC1/16 473JATP	J24185473		43-	A	D2
R 3193	CHIP RES.	10k	1/16W	5%	RMC1/16 103JATP	J24185103		1-	A	D2
R 3194	CHIP RES.	10k	1/16W	5%	RMC1/16 103JATP	J24185103		1-	A	D2
R 3194	CHIP RES.	47k	1/16W	5%	RMC1/16 473JATP	J24185473		43-	A	D2
R 3195	CHIP RES.	4.7k	1/16W	5%	RMC1/16 472JATP	J24185472		1-	A	E3
R 3197	CHIP RES.	4.7k	1/16W	5%	RMC1/16 472JATP	J24185472		1-	A	F1
R 3198	CHIP RES.	4.7k	1/16W	5%	RMC1/16 472JATP	J24185472		1-	A	F2
R 3201	CHIP RES.	0	1/16W	5%	RMC1/16 000JATP	J24185000		1-	A	F3
R 3202	CHIP RES.	10k	1/16W	5%	RMC1/16 103JATP	J24185103		1-	A	D3
R 3204	CHIP RES.	10k	1/16W	5%	RMC1/16 103JATP	J24185103		1-	A	F2
R 3205	CHIP RES.	4.7k	1/16W	5%	RMC1/16 472JATP	J24185472		1-	A	F2
R 3207	CHIP RES.	4.7k	1/16W	5%	RMC1/16 472JATP	J24185472		1-	A	F1
R 3208	CHIP RES.	10k	1/16W	5%	RMC1/16 103JATP	J24185103		1-	A	F1
R 3209	CHIP RES.	10k	1/16W	5%	RMC1/16 103JATP	J24185103		1-	A	F1
R 3210	CHIP RES.	10k	1/16W	5%	RMC1/16 103JATP	J24185103		1-	A	F2
R 3211	CHIP RES.	1k	1/16W	5%	RMC1/16 102JATP	J24185102		1-	A	E1
R 3212	CHIP RES.	1k	1/16W	5%	RMC1/16 102JATP	J24185102		1-	A	F1
R 3213	CHIP RES.	1k	1/16W	5%	RMC1/16 102JATP	J24185102		1-	A	F1
R 3214	CHIP RES.	10k	1/16W	5%	RMC1/16 103JATP	J24185103		1-	A	F1
R 3214	CHIP RES.	47k	1/16W	5%	RMC1/16 473JATP	J24185473		43-	A	F1
R 3215	CHIP RES.	10k	1/16W	5%	RMC1/16 103JATP	J24185103		1-	A	E1
R 3215	CHIP RES.	47k	1/16W	5%	RMC1/16 473JATP	J24185473		43-	A	E1
R 3216	CHIP RES.	10k	1/16W	5%	RMC1/16 103JATP	J24185103		1-	A	F1
R 3216	CHIP RES.	47k	1/16W	5%	RMC1/16 473JATP	J24185473		43-	A	F1
R 3217	CHIP RES.	4.7k	1/16W	5%	RMC1/16 472JATP	J24185472		1-	A	F1
R 3219	CHIP RES.	100k	1/16W	5%	RMC1/16 104JATP	J24185104		1-	A	F1
R 3220	CHIP RES.	1k	1/16W	5%	RMC1/16 102JATP	J24185102		1-	A	D1
R 3221	CHIP RES.	1k	1/16W	5%	RMC1/16 102JATP	J24185102		1-	A	D2
R 3222	CHIP RES.	1k	1/16W	5%	RMC1/16 102JATP	J24185102		1-	A	D1

CNTL Unit

Parts List

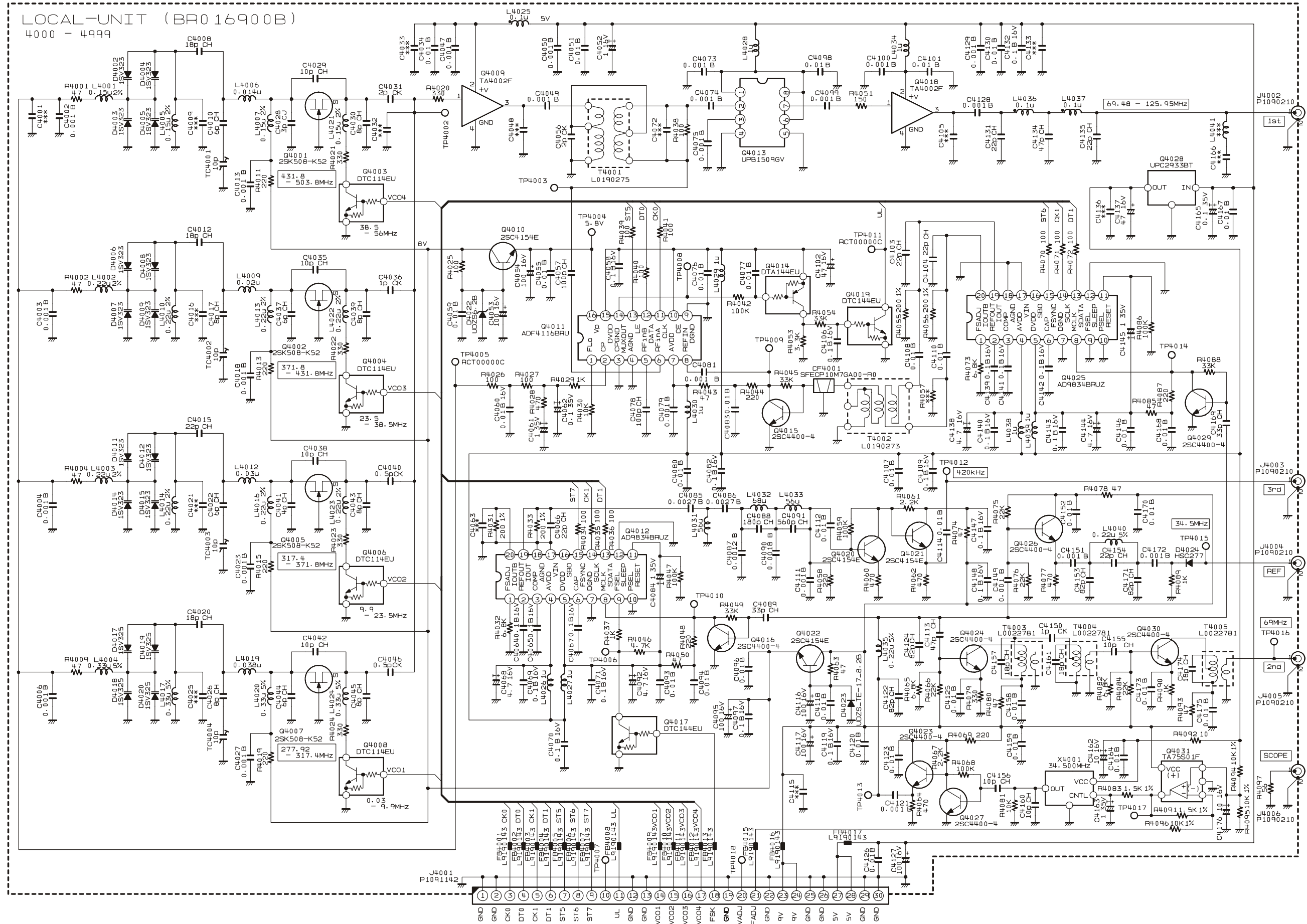

LOCAL Unit

Note

LOCAL Unit

Parts Layout (Side A)

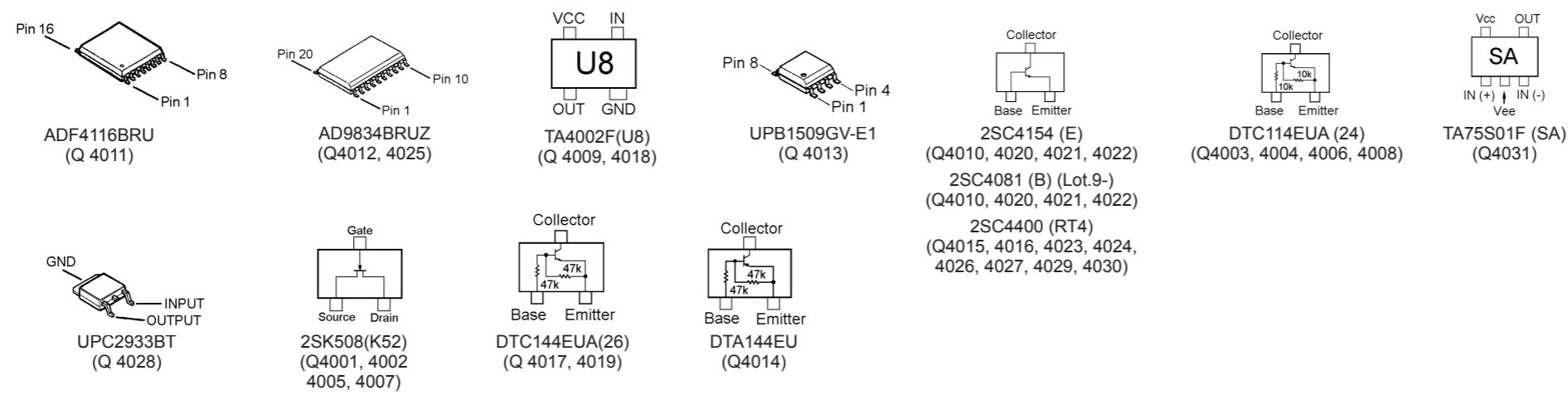
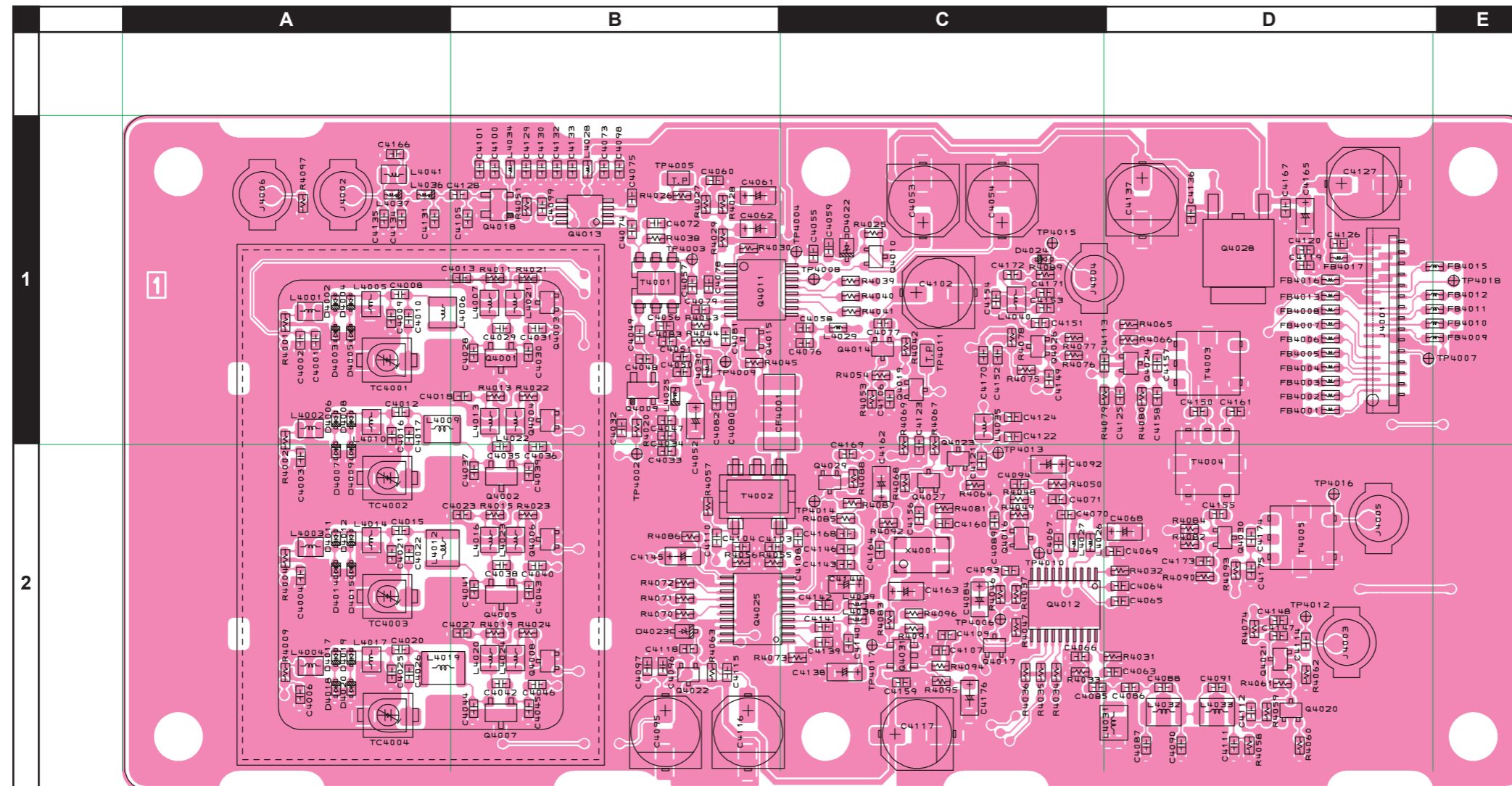

LOCAL Unit

Parts Layout (Side B)

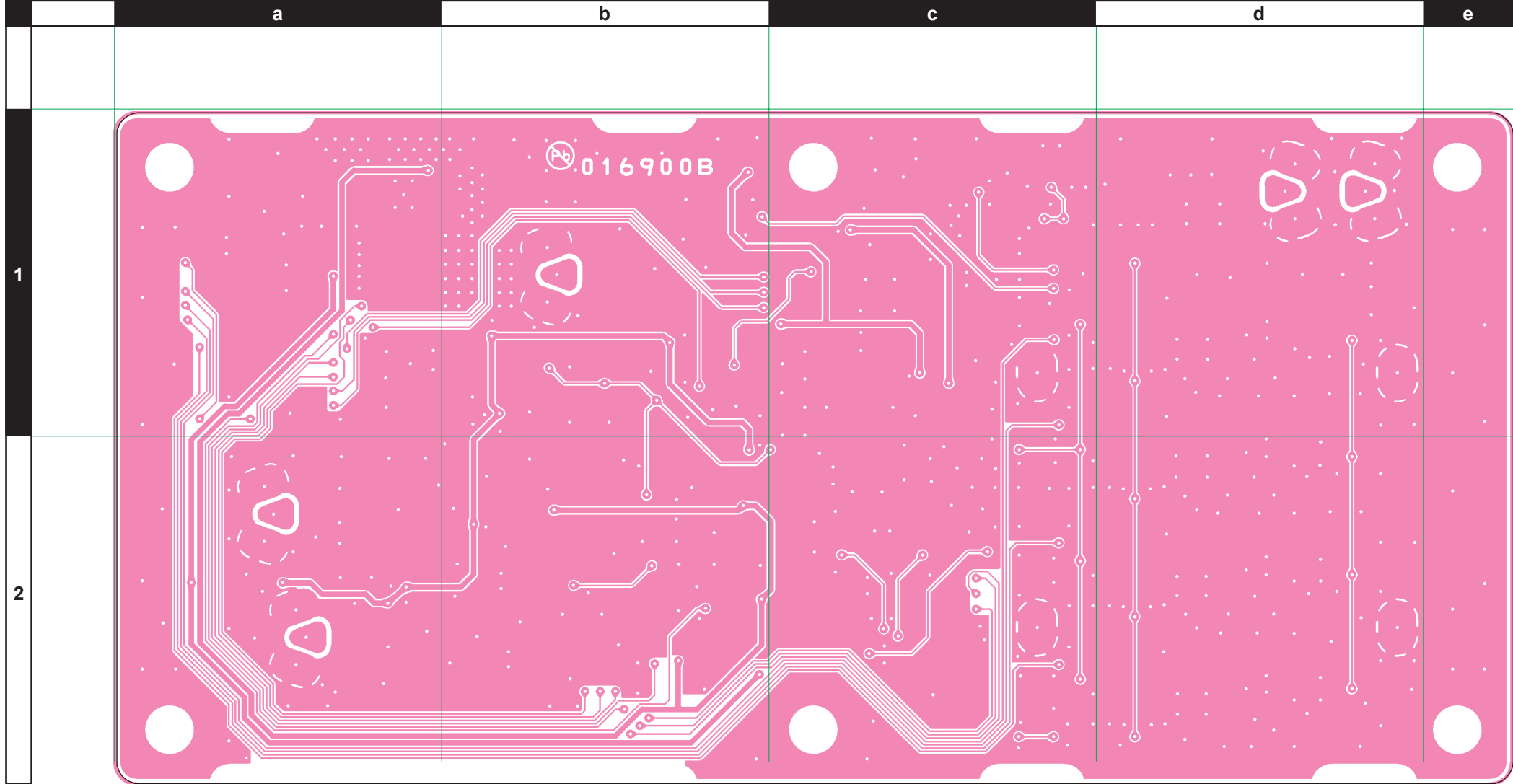

LOCAL Unit

Parts List

REF	DESCRIPTION	VALUE	V/W	TOL.	MFR'S DESIG	VXSTD P/N	VERS.	LOT	SIDE	LAY ADR	
PCB with Components						CS1967001					
Printed Circuit Board						FR016900B			1-		
C 4002	CHIP CAP.	0.001uF	50V	B	GRM188B11H102KA01D	K22174821		1-	A	A1	
C 4003	CHIP CAP.	0.001uF	50V	B	GRM188B11H102KA01D	K22174821		1-	A	A2	
C 4004	CHIP CAP.	0.001uF	50V	B	GRM188B11H102KA01D	K22174821		1-	A	A2	
C 4006	CHIP CAP.	0.001uF	50V	B	GRM188B11H102KA01D	K22174821		1-	A	A2	
C 4008	CHIP CAP.	18pF	50V	CH	GRM1882C1H180JA01D	K22174217		1-	A	A1	
C 4010	CHIP CAP.	6pF	50V	CH	GRM1882C1H6R0DZ01D	K22174207		1-	A	A1	
C 4012	CHIP CAP.	18pF	50V	CH	GRM1882C1H180JA01D	K22174217		1-	A	A1	
C 4013	CHIP CAP.	0.001uF	50V	B	GRM188B11H102KA01D	K22174821		1-	A	B1	
C 4015	CHIP CAP.	22pF	50V	CH	GRM1882C1H220JA01D	K22174219		1-	A	A2	
C 4017	CHIP CAP.	8pF	50V	CH	GRM1882C1H8R0DZ01D	K22174209		1-	A	A1	
C 4018	CHIP CAP.	0.001uF	50V	B	GRM188B11H102KA01D	K22174821		1-	A	B1	
C 4020	CHIP CAP.	18pF	50V	CH	GRM1882C1H180JA01D	K22174217		1-	A	A2	
C 4020	CHIP CAP.	20pF	50V	CH	GRM1882C1H200JZ01D	K22174218		24-	A	A2	
C 4022	CHIP CAP.	6pF	50V	CH	GRM1882C1H6R0DZ01D	K22174207		1-	A	A2	
C 4023	CHIP CAP.	0.001uF	50V	B	GRM188B11H102KA01D	K22174821		1-	A	B2	
C 4026	CHIP CAP.	8pF	50V	CH	GRM1882C1H8R0DZ01D	K22174209		1-	A	A2	
C 4027	CHIP CAP.	0.001uF	50V	B	GRM188B11H102KA01D	K22174821		1-	A	B2	
C 4028	CHIP CAP.	3pF	50V	CJ	GRM1883C1H3R0CZ01D	K22174204		1-	A	B1	
C 4029	CHIP CAP.	10pF	50V	CH	GRM1882C1H100JA01D	K22174211		1-	A	B1	
C 4030	CHIP CAP.	8pF	50V	CH	GRM1882C1H8R0DZ01D	K22174209		1-	A	B1	
C 4031	CHIP CAP.	2pF	50V	CK	GRM1884C1H2R0CZ01D	K22174203		1-	A	B1	
C 4034	CHIP CAP.	0.01uF	50V	B	GRM188B11H103KA01D	K22174823		1-	A	B1	
C 4035	CHIP CAP.	10pF	50V	CH	GRM1882C1H100JA01D	K22174211		1-	A	B2	
C 4036	CHIP CAP.	1pF	50V	CK	GRM1884C1H1R0CZ01D	K22174202		1-	A	B2	
C 4037	CHIP CAP.	6pF	50V	CH	GRM1882C1H6R0DZ01D	K22174207		1-	A	B2	
C 4038	CHIP CAP.	10pF	50V	CH	GRM1882C1H100JA01D	K22174211		1-	A	B2	
C 4039	CHIP CAP.	8pF	50V	CH	GRM1882C1H8R0DZ01D	K22174209		1-	A	B2	
C 4040	CHIP CAP.	0.5pF	50V	CK	GRM1884C1HR50CZ01D	K22174201		1-	A	B2	
C 4041	CHIP CAP.	4pF	50V	CH	GRM1882C1H4R0CZ01D	K22174205		1-	A	B2	
C 4042	CHIP CAP.	10pF	50V	CH	GRM1882C1H100JA01D	K22174211		1-	A	B2	
C 4043	CHIP CAP.	8pF	50V	CH	GRM1882C1H8R0DZ01D	K22174209		1-	A	B2	
C 4044	CHIP CAP.	6pF	50V	CH	GRM1882C1H6R0DZ01D	K22174207		1-	A	B2	
C 4045	CHIP CAP.	8pF	50V	CH	GRM1882C1H8R0DZ01D	K22174209		1-	A	B2	
C 4046	CHIP CAP.	0.5pF	50V	CK	GRM1884C1HR50CZ01D	K22174201		1-	A	B2	
C 4047	CHIP CAP.	0.001uF	50V	B	GRM188B11H102KA01D	K22174821		1-	A	B1	
C 4049	CHIP CAP.	0.001uF	50V	B	GRM188B11H102KA01D	K22174821		1-	A	B1	
C 4050	CHIP CAP.	0.001uF	50V	B	GRM188B11H102KA01D	K22174821		1-	A	B1	
C 4051	CHIP CAP.	0.01uF	50V	B	GRM188B11H103KA01D	K22174823		1-	A	B1	
C 4052	CHIP TA.CAP.	1uF	16V		TEESVA1C105M8R	K78120009		1-	A	B1	
C 4053	AL.ELECTRO.CAP.	100uF	16V		EEE1CA101WP	K48120012		1-	A	C1	
C 4054	AL.ELECTRO.CAP.	100uF	16V		EEE1CA101WP	K48120012		1-	A	C1	
C 4055	CHIP CAP.	0.01uF	50V	B	GRM188B11H103JA01D	K22174824		1-	A	C1	
C 4056	CHIP CAP.	2pF	50V	CK	GRM1884C1H2R0CZ01D	K22174203		1-	A	B1	
C 4057	CHIP CAP.	100pF	50V	CH	GRM1882C1H101JA01D	K22174235		1-	A	B1	
C 4058	CHIP CAP.	0.1uF	16V	B	GRM188B11C104KA01D	K22124805		1-	A	C1	
C 4059	CHIP CAP.	0.01uF	50V	B	GRM188B11H103KA01D	K22174823		1-	A	C1	
C 4060	CHIP CAP.	0.01uF	16V	B	ECUV1C103KBV	K22129510		1-	A	B1	
C 4060	CHIP CAP.	0.01uF	50V	B	GRM188B11H103KA01D	K22174823		43-	A	B1	
C 4061	CHIP TA.CAP.	1uF	35V		TEESVA1V105M8R	K78160032		1-	A	B1	
C 4062	CHIP TA.CAP.	0.1uF	35V		TEESVA1V104M8R	K78160025		1-	A	B1	
C 4064	CHIP CAP.	0.1uF	16V	B	GRM188B11C104KA01D	K22124805		1-	A	D2	
C 4065	CHIP CAP.	0.1uF	16V	B	GRM188B11C104KA01D	K22124805		1-	A	D2	
C 4066	CHIP CAP.	22pF	50V	CH	GRM1882C1H220JA01D	K22174219		1-	A	C2	
C 4067	CHIP CAP.	0.1uF	16V	B	GRM188B11C104KA01D	K22124805		1-	A	C2	
C 4068	CHIP TA.CAP.	4.7uF	16V		TEESVA1C475M8R	K78120031		1-	A	D2	
C 4069	CHIP CAP.	0.1uF	16V	B	GRM188B11C104KA01D	K22124805		1-	A	D2	
C 4070	CHIP CAP.	0.1uF	16V	B	GRM188B11C104KA01D	K22124805		1-	A	C2	
C 4071	CHIP CAP.	0.1uF	16V	B	GRM188B11C104KA01D	K22124805		1-	A	C2	
C 4073	CHIP CAP.	0.001uF	50V	B	GRM188B11H102KA01D	K22174821		1-	A	B1	
C 4074	CHIP CAP.	0.001uF	50V	B	GRM188B11H102KA01D	K22174821		1-	A	B1	
C 4075	CHIP CAP.	0.001uF	50V	B	GRM188B11H102KA01D	K22174821		1-	A	B1	
C 4076	CHIP CAP.	0.01uF	50V	B	GRM188B11H103KA01D	K22174823		1-	A	C1	
C 4077	CHIP CAP.	0.01uF	50V	B	GRM188B11H103KA01D	K22174823		1-	A	C1	
C 4078	CHIP CAP.	100pF	50V	CH	GRM1882C1H101JA01D	K22174235		1-	A	B1	
C 4079	CHIP CAP.	0.001uF	50V	B	GRM188B11H102KA01D	K22174821		1-	A	B1	
C 4080	CHIP CAP.	0.01uF	50V	B	GRM188B11H103KA01D	K22174823		1-	A	B1	
C 4081	CHIP CAP.	0.001uF	50V	B	GRM188B11H102KA01D	K22174821		1-	A	B1	
C 4082	CHIP CAP.	0.1uF	16V	B	GRM188B11C104KA01D	K22124805		1-	A	B1	
C 4083	CHIP CAP.	0.01uF	50V	B	GRM188B11H103KA01D	K22174823		1-	A	B1	
C 4084	CHIP TA.CAP.	1uF	35V		TEESVA1V105M8R	K78160032		1-	A	C2	
C 4085	CHIP CAP.	0.0027uF	50V	B	GRM188B11H272KA01D	K22174829		1-	A	C2	

LOCAL Unit

Parts List

REF	DESCRIPTION	VALUE	V/W	TOL.	MFR'S DESIG	VXSTD P/N	VERS.	LOT	SIDE	LAY ADR
C 4086	CHIP CAP.	0.0027uF	50V	B	GRM188B11H272KA01D	K22174829		1-	A	D2
C 4087	CHIP CAP.	0.0012uF	50V	B	GRM188B11H122KA01D	K22174826		1-	A	D2
C 4088	CHIP CAP.	180pF	50V	CH	GRM1882C1H181JA01D	K22174241		1-	A	D2
C 4089	CHIP CAP.	33pF	50V	CH	GRM1882C1H330JA01D	K22174223		1-	A	C2
C 4090	CHIP CAP.	0.0018uF	50V	B	GRM188B11H182KA01D	K22174828		1-	A	D2
C 4091	CHIP CAP.	560pF	50V	CH	GRM1882C1H561JA01D	K22174273		1-	A	D2
C 4092	CHIP TA.CAP.	4.7uF	16V		TEESVA1C475M8R	K78120031		1-	A	C2
C 4093	CHIP CAP.	0.01uF	50V	B	GRM188B11H103KA01D	K22174823		1-	A	C2
C 4094	CHIP CAP.	0.01uF	50V	B	GRM188B11H103KA01D	K22174823		1-	A	C2
C 4095	AL.ELECTRO.CAP.	100uF	16V		EEE1CA101WP	K48120012		1-	A	B2
C 4096	CHIP CAP.	0.01uF	50V	B	GRM188B11H103KA01D	K22174823		1-	A	B2
C 4097	CHIP CAP.	0.1uF	16V	B	GRM188B11C104KA01D	K22124805		1-	A	B2
C 4098	CHIP CAP.	0.01uF	50V	B	GRM188B11H103KA01D	K22174823		1-	A	B1
C 4099	CHIP CAP.	0.001uF	50V	B	GRM188B11H102KA01D	K22174821		1-	A	B1
C 4100	CHIP CAP.	0.001uF	50V	B	GRM188B11H102KA01D	K22174821		1-	A	B1
C 4101	CHIP CAP.	0.01uF	50V	B	GRM188B11H103KA01D	K22174823		1-	A	B1
C 4102	AL.ELECTRO.CAP.	47uF	16V		EEE1CA470SP	K48120005		1-	A	C1
C 4103	CHIP CAP.	22pF	50V	CH	GRM1882C1H220JA01D	K22174219		1-	A	B2
C 4104	CHIP CAP.	22pF	50V	CH	GRM1882C1H220JA01D	K22174219		1-	A	B2
C 4106	CHIP CAP.	0.1uF	16V	B	GRM188B11C104KA01D	K22124805		1-	A	C1
C 4107	CHIP CAP.	0.01uF	50V	B	GRM188B11H103KA01D	K22174823		1-	A	C2
C 4108	CHIP CAP.	0.01uF	50V	B	GRM188B11H103KA01D	K22174823		1-	A	C2
C 4109	CHIP CAP.	0.1uF	16V	B	GRM188B11C104KA01D	K22124805		1-	A	C2
C 4110	CHIP CAP.	0.01uF	50V	B	GRM188B11H103KA01D	K22174823		1-	A	B2
C 4111	CHIP CAP.	0.001uF	50V	B	GRM188B11H102KA01D	K22174821		1-	A	D2
C 4112	CHIP CAP.	0.01uF	50V	B	GRM188B11H103KA01D	K22174823		1-	A	D2
C 4113	CHIP CAP.	47pF	50V	CH	GRM1882C1H470JA01D	K22174227		1-	A	C1
C 4114	CHIP CAP.	0.01uF	50V	B	GRM188B11H103KA01D	K22174823		1-	A	D2
C 4116	AL.ELECTRO.CAP.	100uF	16V		EEE1CA101WP	K48120012		1-	A	B2
C 4117	AL.ELECTRO.CAP.	100uF	16V		EEE1CA101WP	K48120012		1-	A	C2
C 4118	CHIP CAP.	0.01uF	50V	B	GRM188B11H103KA01D	K22174823		1-	A	B2
C 4119	CHIP CAP.	0.1uF	16V	B	GRM188B11C104KA01D	K22124805		1-	A	D1
C 4120	CHIP CAP.	0.01uF	50V	B	GRM188B11H103KA01D	K22174823		1-	A	D1
C 4121	CHIP CAP.	0.001uF	50V	B	GRM188B11H102KA01D	K22174821		1-	A	C2
C 4122	CHIP CAP.	82pF	50V	CH	GRM1882C1H820JA01D	K22174233		1-	A	C1
C 4123	CHIP CAP.	0.01uF	50V	B	GRM188B11H103KA01D	K22174823		1-	A	C2
C 4124	CHIP CAP.	82pF	50V	CH	GRM1882C1H820JA01D	K22174233		1-	A	C1
C 4125	CHIP CAP.	0.01uF	50V	B	GRM188B11H103KA01D	K22174823		1-	A	D1
C 4126	CHIP CAP.	0.01uF	50V	B	GRM188B11H103KA01D	K22174823		1-	A	D1
C 4127	AL.ELECTRO.CAP.	100uF	16V		EEE1CA101WP	K48120012		1-	A	D1
C 4128	CHIP CAP.	0.001uF	50V	B	GRM188B11H102KA01D	K22174821		1-	A	B1
C 4129	CHIP CAP.	0.001uF	50V	B	GRM188B11H102KA01D	K22174821		1-	A	B1
C 4130	CHIP CAP.	0.01uF	50V	B	GRM188B11H103KA01D	K22174823		1-	A	B1
C 4131	CHIP CAP.	22pF	50V	CH	GRM1882C1H220JA01D	K22174219		1-	A	A1
C 4132	CHIP CAP.	0.1uF	16V	B	GRM188B11C104KA01D	K22124805		1-	A	B1
C 4134	CHIP CAP.	47pF	50V	CH	GRM1882C1H470JA01D	K22174227		1-	A	A1
C 4135	CHIP CAP.	22pF	50V	CH	GRM1882C1H220JA01D	K22174219		1-	A	A1
C 4137	AL.ELECTRO.CAP.	47uF	16V		EEE1CA470SP	K48120005		1-	A	D1
C 4138	CHIP TA.CAP.	4.7uF	16V		TEESVA1C475M8R	K78120031		1-	A	C2
C 4139	CHIP CAP.	0.1uF	16V	B	GRM188B11C104KA01D	K22124805		1-	A	C2
C 4140	CHIP CAP.	0.1uF	16V	B	GRM188B11C104KA01D	K22124805		1-	A	C2
C 4141	CHIP CAP.	0.1uF	16V	B	GRM188B11C104KA01D	K22124805		1-	A	C2
C 4142	CHIP CAP.	0.1uF	16V	B	GRM188B11C104KA01D	K22124805		1-	A	C2
C 4143	CHIP CAP.	0.1uF	16V	B	GRM188B11C104KA01D	K22124805		1-	A	C2
C 4144	CHIP TA.CAP.	4.7uF	16V		TEESVA1C475M8R	K78120031		1-	A	C2
C 4145	CHIP TA.CAP.	1uF	35V		TEESVA1V105M8R	K78160032		1-	A	B2
C 4146	CHIP CAP.	0.01uF	50V	B	GRM188B11H103KA01D	K22174823		1-	A	C2
C 4147	CHIP CAP.	0.1uF	16V	B	GRM188B11C104KA01D	K22124805		1-	A	D2
C 4148	CHIP CAP.	0.1uF	16V	B	GRM188B11C104KA01D	K22124805		1-	A	D2
C 4149	CHIP CAP.	0.001uF	50V	B	GRM188B11H102KA01D	K22174821		1-	A	C1
C 4150	CHIP CAP.	1pF	50V	CK	GRM1884C1H1R0CZ01D	K22174202		1-	A	D1
C 4151	CHIP CAP.	0.001uF	50V	B	GRM188B11H102KA01D	K22174821		1-	A	C1
C 4152	CHIP CAP.	0.01uF	50V	B	GRM188B11H103KA01D	K22174823		1-	A	C1
C 4153	CHIP CAP.	82pF	50V	CH	GRM1882C1H820JA01D	K22174233		1-	A	C1
C 4154	CHIP CAP.	22pF	50V	CH	GRM1882C1H220JA01D	K22174219		1-	A	C1
C 4155	CHIP CAP.	10pF	50V	CH	GRM1882C1H100JA01D	K22174211		1-	A	D2
C 4156	CHIP CAP.	10pF	50V	CH	GRM1882C1H100JA01D	K22174211		1-	A	C2
C 4157	CHIP CAP.	18pF	50V	CH	GRM1882C1H180JA01D	K22174217		1-	A	D1
C 4158	CHIP CAP.	0.01uF	50V	B	GRM188B11H103KA01D	K22174823		1-	A	D1
C 4159	CHIP CAP.	0.01uF	50V	B	GRM188B11H103KA01D	K22174823		1-	A	C2
C 4160	CHIP CAP.	10pF	50V	CH	GRM1882C1H100JA01D	K22174211		1-	A	C2
C 4161	CHIP CAP.	18pF	50V	CH	GRM1882C1H180JA01D	K22174217		1-	A	D1
C 4162	CHIP TA.CAP.	10uF	16V		TEESVA1C106M8R	K78120077		1-	A	C2

LOCAL Unit

Parts List

REF	DESCRIPTION	VALUE	V/W	TOL.	MFR'S DESIG	VXSTD P/N	VERS.	LOT	SIDE	LAY ADR
C 4163	CHIP TA.CAP.	1uF	35V		TEESVA1V105M8R	K78160032		1-	A	C2
C 4164	CHIP CAP.	0.01uF	50V	B	GRM188B11H103KA01D	K22174823		1-	A	C2
C 4165	CHIP TA.CAP.	0.1uF	35V		TEESVA1V104M8R	K78160025		1-	A	D1
C 4167	CHIP CAP.	0.01uF	50V	B	GRM188B11H103KA01D	K22174823		1-	A	D1
C 4168	CHIP CAP.	0.01uF	50V	B	GRM188B11H103KA01D	K22174823		1-	A	C2
C 4169	CHIP CAP.	33pF	50V	CH	GRM1882C1H330JA01D	K22174223		1-	A	C2
C 4170	CHIP CAP.	0.01uF	50V	B	GRM188B11H103KA01D	K22174823		1-	A	C1
C 4171	CHIP CAP.	82pF	50V	CH	GRM1882C1H820JA01D	K22174233		1-	A	C1
C 4172	CHIP CAP.	0.001uF	50V	B	GRM188B11H102KA01D	K22174821		1-	A	C1
C 4173	CHIP CAP.	0.01uF	50V	B	GRM188B11H103KA01D	K22174823		1-	A	D2
C 4174	CHIP CAP.	18pF	50V	CH	GRM1882C1H180JA01D	K22174217		1-	A	D2
C 4175	CHIP CAP.	0.01uF	50V	B	GRM188B11H103KA01D	K22174823		1-	A	D2
C 4176	CHIP TA.CAP.	10uF	16V		TEESVA1C106M8R	K78120077		1-	A	C2
CF4001	CERAMIC FILTER				SFCEP10M7GA00-R0	H3900514		1-	A	B1
D 4002	DIODE				1SV323(TPH3.F)	G2071006		1-	A	A1
D 4003	DIODE				1SV323(TPH3.F)	G2071006		1-	A	A1
D 4004	DIODE				1SV323(TPH3.F)	G2071006		1-	A	A1
D 4005	DIODE				1SV323(TPH3.F)	G2071006		1-	A	A1
D 4006	DIODE				1SV323(TPH3.F)	G2071006		1-	A	A1
D 4007	DIODE				1SV323(TPH3.F)	G2071006		1-	A	A2
D 4008	DIODE				1SV323(TPH3.F)	G2071006		1-	A	A1
D 4009	DIODE				1SV323(TPH3.F)	G2071006		1-	A	A2
D 4011	DIODE				1SV323(TPH3.F)	G2071006		1-	A	A2
D 4012	DIODE				1SV323(TPH3.F)	G2071006		1-	A	A2
D 4014	DIODE				1SV323(TPH3.F)	G2071006		1-	A	A2
D 4015	DIODE				1SV323(TPH3.F)	G2071006		1-	A	A2
D 4017	DIODE				1SV325(TPH3.F)	G2070848		1-	A	A2
D 4018	DIODE				1SV325(TPH3.F)	G2070848		1-	A	A2
D 4019	DIODE				1SV325(TPH3.F)	G2070848		1-	A	A2
D 4020	DIODE				1SV325(TPH3.F)	G2070848		1-	A	A2
D 4022	DIODE				UDZS TE-17 6.2B	G2070912		1-	A	C1
D 4023	DIODE				UDZS TE-17 8.2B	G2070890		1-	A	B2
D 4024	DIODE				HSC277TRF-E	G2070584		1-	A	C1
FB4001	FERRITE BEADS				BLM18BD601SN1D	L9190143		1-	A	D1
FB4002	FERRITE BEADS				BLM18BD601SN1D	L9190143		1-	A	D1
FB4003	FERRITE BEADS				BLM18BD601SN1D	L9190143		1-	A	D1
FB4004	FERRITE BEADS				BLM18BD601SN1D	L9190143		1-	A	D1
FB4005	FERRITE BEADS				BLM18BD601SN1D	L9190143		1-	A	D1
FB4006	FERRITE BEADS				BLM18BD601SN1D	L9190143		1-	A	D1
FB4007	FERRITE BEADS				BLM18BD601SN1D	L9190143		1-	A	D1
FB4008	FERRITE BEADS				BLM18BD601SN1D	L9190143		1-	A	D1
FB4009	FERRITE BEADS				BLM18BD601SN1D	L9190143		1-	A	D1
FB4010	FERRITE BEADS				BLM18BD601SN1D	L9190143		1-	A	D1
FB4011	FERRITE BEADS				BLM18BD601SN1D	L9190143		1-	A	D1
FB4012	FERRITE BEADS				BLM18BD601SN1D	L9190143		1-	A	D1
FB4013	FERRITE BEADS				BLM18BD601SN1D	L9190143		1-	A	D1
FB4015	FERRITE BEADS				BLM18BD601SN1D	L9190143		1-	A	D1
FB4016	FERRITE BEADS				BLM18BD601SN1D	L9190143		1-	A	D1
FB4017	FERRITE BEADS				BLM18BD601SN1D	L9190143		1-	A	D1
J 4001	CONNECTOR				30FLT-SM2-TB(LF)(SN)(M)	P1091142		1-	A	D1
J 4002	CONNECTOR				TMP-J01X-V6	P1090210		1-	A	A1
J 4003	CONNECTOR				TMP-J01X-V6	P1090210		1-	A	D2
J 4004	CONNECTOR				TMP-J01X-V6	P1090210		1-	A	C1
J 4005	CONNECTOR				TMP-J01X-V6	P1090210		1-	A	D2
J 4006	CONNECTOR				TMP-J01X-V6	P1090210		1-	A	A1
L 4001	M.RFC	0.15uH		2%	C2012C-R15G-RA	L1690778		1-	A	A1
L 4002	M.RFC	0.22uH		2%	C2012C-R22G-RA	L1690780		1-	A	A1
L 4003	M.RFC	0.22uH		2%	C2012C-R22G-RA	L1690780		1-	A	A2
L 4004	M.RFC	0.33uH		5%	C2012C-R33J	L1691018		1-	A	A2
L 4005	M.RFC	0.15uH		2%	C2012C-R15G-RA	L1690778		1-	A	A1
L 4006	COIL	0.014uH			AS050425-14NJ	L0022827		1-	A	A1
L 4007	M.RFC	0.15uH		2%	C2012C-R15G-RA	L1690778		1-	A	B1
L 4009	COIL	0.0195uH			AS050525-19R5NJ	L0022849		1-	A	A1
L 4010	M.RFC	0.22uH		2%	C2012C-R22G-RA	L1690780		1-	A	A1
L 4012	COIL	0.03uH			AS050530-30N	L0022997		1-	A	A2
L 4013	M.RFC	0.22uH		2%	C2012C-R22G-RA	L1690780		1-	A	B1
L 4014	M.RFC	0.22uH		2%	C2012C-R22G-RA	L1690780		1-	A	A2
L 4016	M.RFC	0.22uH		2%	C2012C-R22G-RA	L1690780		1-	A	B2
L 4017	M.RFC	0.33uH		5%	C2012C-R33J	L1691018		1-	A	A2
L 4019	COIL	0.038uH			AS050630-38N	L0022818		1-	A	A2
L 4020	M.RFC	0.33uH		5%	C2012C-R33J	L1691018		1-	A	B2
L 4021	M.RFC	0.15uH		2%	C2012C-R15G-RA	L1690778		1-	A	B1
L 4022	M.RFC	0.22uH		2%	C2012C-R22G-RA	L1690780		1-	A	B1

LOCAL Unit

Parts List

REF	DESCRIPTION	VALUE	V/W	TOL.	MFR'S DESIG	VXSTD P/N	VERS.	LOT	SIDE	LAY ADR
L 4023	M.RFC	0.22uH		2%	C2012C-R22G-RA	L1690780		1-	A	B2
L 4024	M.RFC	0.33uH		5%	C2012C-R33J	L1691018		1-	A	B2
L 4025	M.RFC	0.1uH			HK1608 R10J-T	L1690528		1-	A	B1
L 4026	M.RFC	1uH			LK1608 1R0K-T	L1690687		1-	A	C2
L 4027	M.RFC	1uH			LK1608 1R0K-T	L1690687		1-	A	C2
L 4028	M.RFC	1uH			LK1608 1R0K-T	L1690687		1-	A	B1
L 4029	M.RFC	1uH			LK1608 1R0K-T	L1690687		1-	A	C1
L 4030	M.RFC	1uH			LK1608 1R0K-T	L1690687		1-	A	B1
L 4031	M.RFC	56uH			LLM3225-560J	L1691142		1-	A	D2
L 4032	M.RFC	68uH			LLM3225-680J	L1691143		1-	A	D2
L 4033	M.RFC	56uH			LLM3225-560J	L1691142		1-	A	D2
L 4034	M.RFC	1uH			LK1608 1R0K-T	L1690687		1-	A	B1
L 4035	M.RFC	0.22uH		5%	C2012C-R22J	L1690796		1-	A	C1
L 4036	M.RFC	0.1uH			HK1608 R10J-T	L1690528		1-	A	A1
L 4037	M.RFC	0.1uH			HK1608 R10J-T	L1690528		1-	A	A1
L 4038	M.RFC	1uH			LK1608 1R0K-T	L1690687		1-	A	C2
L 4039	M.RFC	1uH			LK1608 1R0K-T	L1690687		1-	A	C2
L 4040	M.RFC	0.22uH		5%	C2012C-R22J	L1690796		1-	A	C1
Q 4001	FET				2SK508-T2B K52 A	G3805087B		1-	A	B1
Q 4002	FET				2SK508-T2B K52 A	G3805087B		1-	A	B2
Q 4003	TRANSISTOR				DTC114EUA T106	G3070084		1-	A	B1
Q 4004	TRANSISTOR				DTC114EUA T106	G3070084		1-	A	B1
Q 4005	FET				2SK508-T2B K52 A	G3805087B		1-	A	B2
Q 4006	TRANSISTOR				DTC114EUA T106	G3070084		1-	A	B2
Q 4007	FET				2SK508-T2B K52 A	G3805087B		1-	A	B2
Q 4008	TRANSISTOR				DTC114EUA T106	G3070084		1-	A	B2
Q 4009	IC				TA4002F(TE85L.F)	G1092813		1-	A	B1
Q 4010	TRANSISTOR				2SC4154-T111-1E	G3341548E		1-	A	C1
Q 4010	TRANSISTOR				2SC4081 T106	G3340818		9-	A	C1
Q 4011	IC				ADF4116BRU(TAPE)	G1093581		1-	A	B1
Q 4012	IC				AD9834BRUZ-REEL7	G1094297		1-	A	C2
Q 4013	IC				UPB1509GV-E1	G1093149		1-	A	B1
Q 4014	TRANSISTOR				DTA144EU T106	G3070079		1-	A	C1
Q 4015	TRANSISTOR				2SC4400-4-TL	G3344008D		1-	A	B1
Q 4016	TRANSISTOR				2SC4400-4-TL	G3344008D		1-	A	C2
Q 4017	TRANSISTOR				DTC144EUA T106	G3070041		1-	A	C2
Q 4018	IC				TA4002F(TE85L.F)	G1092813		1-	A	B1
Q 4019	TRANSISTOR				DTC144EUA T106	G3070041		1-	A	C1
Q 4020	TRANSISTOR				2SC4154-T111-1E	G3341548E		1-	A	D2
Q 4020	TRANSISTOR				2SC4081 T106	G3340818		9-	A	D2
Q 4021	TRANSISTOR				2SC4154-T111-1E	G3341548E		1-	A	D2
Q 4021	TRANSISTOR				2SC4081 T106	G3340818		9-	A	D2
Q 4022	TRANSISTOR				2SC4154-T111-1E	G3341548E		1-	A	B2
Q 4022	TRANSISTOR				2SC4081 T106	G3340818		9-	A	B2
Q 4023	TRANSISTOR				2SC4400-4-TL	G3344008D		1-	A	C2
Q 4024	TRANSISTOR				2SC4400-4-TL	G3344008D		1-	A	D1
Q 4025	IC				AD9834BRUZ-REEL7	G1094297		1-	A	B2
Q 4026	TRANSISTOR				2SC4400-4-TL	G3344008D		1-	A	C1
Q 4027	TRANSISTOR				2SC4400-4-TL	G3344008D		1-	A	C2
Q 4028	IC				UPC2933BT-E1-AZ	G1094338		1-	A	D1
Q 4029	TRANSISTOR				2SC4400-4-TL	G3344008D		1-	A	C2
Q 4030	TRANSISTOR				2SC4400-4-TL	G3344008D		1-	A	D2
Q 4031	IC				TA75S01F(TE85R.F)	G1091593		1-	A	C2
R 4001	CHIP RES.	47	1/16W	5%	RMC1/16 470JATP	J24185470		1-	A	A1
R 4002	CHIP RES.	47	1/16W	5%	RMC1/16 470JATP	J24185470		1-	A	A1
R 4004	CHIP RES.	47	1/16W	5%	RMC1/16 470JATP	J24185470		1-	A	A2
R 4009	CHIP RES.	47	1/16W	5%	RMC1/16 470JATP	J24185470		1-	A	A2
R 4011	CHIP RES.	220	1/16W	5%	RMC1/16 221JATP	J24185221		1-	A	B1
R 4013	CHIP RES.	220	1/16W	5%	RMC1/16 221JATP	J24185221		1-	A	B1
R 4015	CHIP RES.	220	1/16W	5%	RMC1/16 221JATP	J24185221		1-	A	B2
R 4019	CHIP RES.	220	1/16W	5%	RMC1/16 221JATP	J24185221		1-	A	B2
R 4020	CHIP RES.	330	1/16W	5%	RMC1/16 331JATP	J24185331		1-	A	B1
R 4021	CHIP RES.	330	1/16W	5%	RMC1/16 331JATP	J24185331		1-	A	B1
R 4022	CHIP RES.	330	1/16W	5%	RMC1/16 331JATP	J24185331		1-	A	B1
R 4023	CHIP RES.	330	1/16W	5%	RMC1/16 331JATP	J24185331		1-	A	B2
R 4024	CHIP RES.	330	1/16W	5%	RMC1/16 331JATP	J24185331		1-	A	B2
R 4025	CHIP RES.	100	1/16W	5%	RMC1/16 101JATP	J24185101		1-	A	C1
R 4026	CHIP RES.	100	1/16W	5%	RMC1/16 101JATP	J24185101		1-	A	B1
R 4027	CHIP RES.	100	1/16W	5%	RMC1/16 101JATP	J24185101		1-	A	B1
R 4028	CHIP RES.	470	1/16W	5%	RMC1/16 471JATP	J24185471		1-	A	B1
R 4029	CHIP RES.	1k	1/16W	5%	RMC1/16 102JATP	J24185102		1-	A	B1
R 4030	CHIP RES.	10k	1/16W	5%	RMC1/16 103JATP	J24185103		1-	A	B1
R 4031	CHIP RES.	200	1/16W	1%	RMC1/16 201FTP	J24183201		1-	A	D2

LOCAL Unit

Parts List

REF	DESCRIPTION	VALUE	V/W	TOL.	MFR'S DESIG	VXSTD P/N	VERS.	LOT	SIDE	LAY ADR
R 4032	CHIP RES.	6.8k	1/16W	5%	RMC1/16 682JATP	J24185682		1-	A	D2
R 4033	CHIP RES.	200	1/16W	1%	RMC1/16 201FTP	J24183201		1-	A	C2
R 4034	CHIP RES.	100	1/16W	5%	RMC1/16 101JATP	J24185101		1-	A	C2
R 4035	CHIP RES.	100	1/16W	5%	RMC1/16 101JATP	J24185101		1-	A	C2
R 4036	CHIP RES.	100	1/16W	5%	RMC1/16 101JATP	J24185101		1-	A	C2
R 4037	CHIP RES.	1k	1/16W	5%	RMC1/16 102JATP	J24185102		1-	A	C2
R 4038	CHIP RES.	100	1/16W	5%	RMC1/16 101JATP	J24185101		1-	A	B1
R 4039	CHIP RES.	100	1/16W	5%	RMC1/16 101JATP	J24185101		1-	A	C1
R 4040	CHIP RES.	100	1/16W	5%	RMC1/16 101JATP	J24185101		1-	A	C1
R 4041	CHIP RES.	100	1/16W	5%	RMC1/16 101JATP	J24185101		1-	A	C1
R 4042	CHIP RES.	100k	1/16W	5%	RMC1/16 104JATP	J24185104		1-	A	C1
R 4043	CHIP RES.	47	1/16W	5%	RMC1/16 470JATP	J24185470		1-	A	B1
R 4044	CHIP RES.	220	1/16W	5%	RMC1/16 221JATP	J24185221		1-	A	B1
R 4045	CHIP RES.	33k	1/16W	5%	RMC1/16 333JATP	J24185333		1-	A	B1
R 4046	CHIP RES.	4.7k	1/16W	5%	RMC1/16 472JATP	J24185472		1-	A	C2
R 4047	CHIP RES.	100k	1/16W	5%	RMC1/16 104JATP	J24185104		1-	A	C2
R 4048	CHIP RES.	220	1/16W	5%	RMC1/16 221JATP	J24185221		1-	A	C2
R 4049	CHIP RES.	33k	1/16W	5%	RMC1/16 333JATP	J24185333		1-	A	C2
R 4050	CHIP RES.	47	1/16W	5%	RMC1/16 470JATP	J24185470		1-	A	C2
R 4051	CHIP RES.	150	1/16W	5%	RMC1/16 151JATP	J24185151		1-	A	B1
R 4053	CHIP RES.	3.3k	1/16W	5%	RMC1/16 332JATP	J24185332		1-	A	C1
R 4054	CHIP RES.	33k	1/16W	5%	RMC1/16 333JATP	J24185333		1-	A	C1
R 4055	CHIP RES.	200	1/16W	1%	RMC1/16 201FTP	J24183201		1-	A	B2
R 4056	CHIP RES.	200	1/16W	1%	RMC1/16 201FTP	J24183201		1-	A	B2
R 4058	CHIP RES.	220	1/16W	5%	RMC1/16 221JATP	J24185221		1-	A	D2
R 4059	CHIP RES.	100k	1/16W	5%	RMC1/16 104JATP	J24185104		1-	A	D2
R 4060	CHIP RES.	470	1/16W	5%	RMC1/16 471JATP	J24185471		1-	A	D2
R 4061	CHIP RES.	2.2k	1/16W	5%	RMC1/16 222JATP	J24185222		1-	A	D2
R 4062	CHIP RES.	470	1/16W	5%	RMC1/16 471JATP	J24185471		1-	A	D2
R 4063	CHIP RES.	47	1/16W	5%	RMC1/16 470JATP	J24185470		1-	A	B2
R 4064	CHIP RES.	470	1/16W	5%	RMC1/16 471JATP	J24185471		1-	A	C2
R 4065	CHIP RES.	6.8k	1/16W	5%	RMC1/16 682JATP	J24185682		1-	A	D1
R 4066	CHIP RES.	22k	1/16W	5%	RMC1/16 223JATP	J24185223		1-	A	D1
R 4067	CHIP RES.	2.2k	1/16W	5%	RMC1/16 222JATP	J24185222		1-	A	C2
R 4068	CHIP RES.	100k	1/16W	5%	RMC1/16 104JATP	J24185104		1-	A	C2
R 4069	CHIP RES.	220	1/16W	5%	RMC1/16 221JATP	J24185221		1-	A	C2
R 4070	CHIP RES.	100	1/16W	5%	RMC1/16 101JATP	J24185101		1-	A	B2
R 4071	CHIP RES.	100	1/16W	5%	RMC1/16 101JATP	J24185101		1-	A	B2
R 4072	CHIP RES.	100	1/16W	5%	RMC1/16 101JATP	J24185101		1-	A	B2
R 4073	CHIP RES.	6.8k	1/16W	5%	RMC1/16 682JATP	J24185682		1-	A	C2
R 4074	CHIP RES.	47	1/16W	5%	RMC1/16 470JATP	J24185470		1-	A	D2
R 4075	CHIP RES.	22k	1/16W	5%	RMC1/16 223JATP	J24185223		1-	A	C1
R 4076	CHIP RES.	22k	1/16W	5%	RMC1/16 223JATP	J24185223		1-	A	C1
R 4077	CHIP RES.	470	1/16W	5%	RMC1/16 471JATP	J24185471		1-	A	C1
R 4078	CHIP RES.	47	1/16W	5%	RMC1/16 470JATP	J24185470		1-	A	C1
R 4079	CHIP RES.	330	1/16W	5%	RMC1/16 331JATP	J24185331		1-	A	C1
R 4080	CHIP RES.	47	1/16W	5%	RMC1/16 470JATP	J24185470		1-	A	D1
R 4081	CHIP RES.	10k	1/16W	5%	RMC1/16 103JATP	J24185103		1-	A	C2
R 4082	CHIP RES.	6.8k	1/16W	5%	RMC1/16 682JATP	J24185682		1-	A	D2
R 4083	CHIP RES.	1.5k	1/16W	1%	RMC1/16 152FTP	J24183152		1-	A	C2
R 4084	CHIP RES.	22k	1/16W	5%	RMC1/16 223JATP	J24185223		1-	A	D2
R 4085	CHIP RES.	47	1/16W	5%	RMC1/16 470JATP	J24185470		1-	A	C2
R 4086	CHIP RES.	100k	1/16W	5%	RMC1/16 104JATP	J24185104		1-	A	B2
R 4087	CHIP RES.	220	1/16W	5%	RMC1/16 221JATP	J24185221		1-	A	C2
R 4088	CHIP RES.	33k	1/16W	5%	RMC1/16 333JATP	J24185333		1-	A	C2
R 4089	CHIP RES.	1k	1/16W	5%	RMC1/16 102JATP	J24185102		1-	A	C1
R 4090	CHIP RES.	1k	1/16W	5%	RMC1/16 102JATP	J24185102		1-	A	D2
R 4091	CHIP RES.	1.5k	1/16W	1%	RMC1/16 152FTP	J24183152		1-	A	C2
R 4092	CHIP RES.	10	1/16W	5%	RMC1/16 100JATP	J24185100		1-	A	C2
R 4093	CHIP RES.	47	1/16W	5%	RMC1/16 470JATP	J24185470		1-	A	D2
R 4094	CHIP RES.	10k	1/16W	1%	RMC1/16 103FTP	J24183103		1-	A	C2
R 4095	CHIP RES.	10k	1/16W	1%	RMC1/16 103FTP	J24183103		1-	A	C2
R 4096	CHIP RES.	10k	1/16W	1%	RMC1/16 103FTP	J24183103		1-	A	C2
R 4097	CHIP RES.	56	1/16W	5%	RMC1/16 560JATP	J24185560		1-	A	A1
T 4001	BALUN TRANSFORMERS				#617DS-1710	L0190275		1-	A	B1
T 4002	BALUN TRANSFORMERS				#458PT-1565	L0190273		1-	A	B2
T 4003	COIL 05RF				74.62M 010812302	L0022781		1-	A	D1
T 4004	COIL 05RF				74.62M 010812302	L0022781		1-	A	D2
T 4005	COIL 05RF				74.62M 010812302	L0022781		1-	A	D2
TC4001	TRIMMER CAP.	10pF			TZB4Z100AB10R00	K91000279		1-	A	A1
TC4002	TRIMMER CAP.	10pF			TZB4Z100AB10R00	K91000279		1-	A	A2
TC4003	TRIMMER CAP.	10pF			TZB4Z100AB10R00	K91000279		1-	A	A2
TC4004	TRIMMER CAP.	10pF			TZB4Z100AB10R00	K91000279		1-	A	A2

PA-A Unit Circuit Diagram

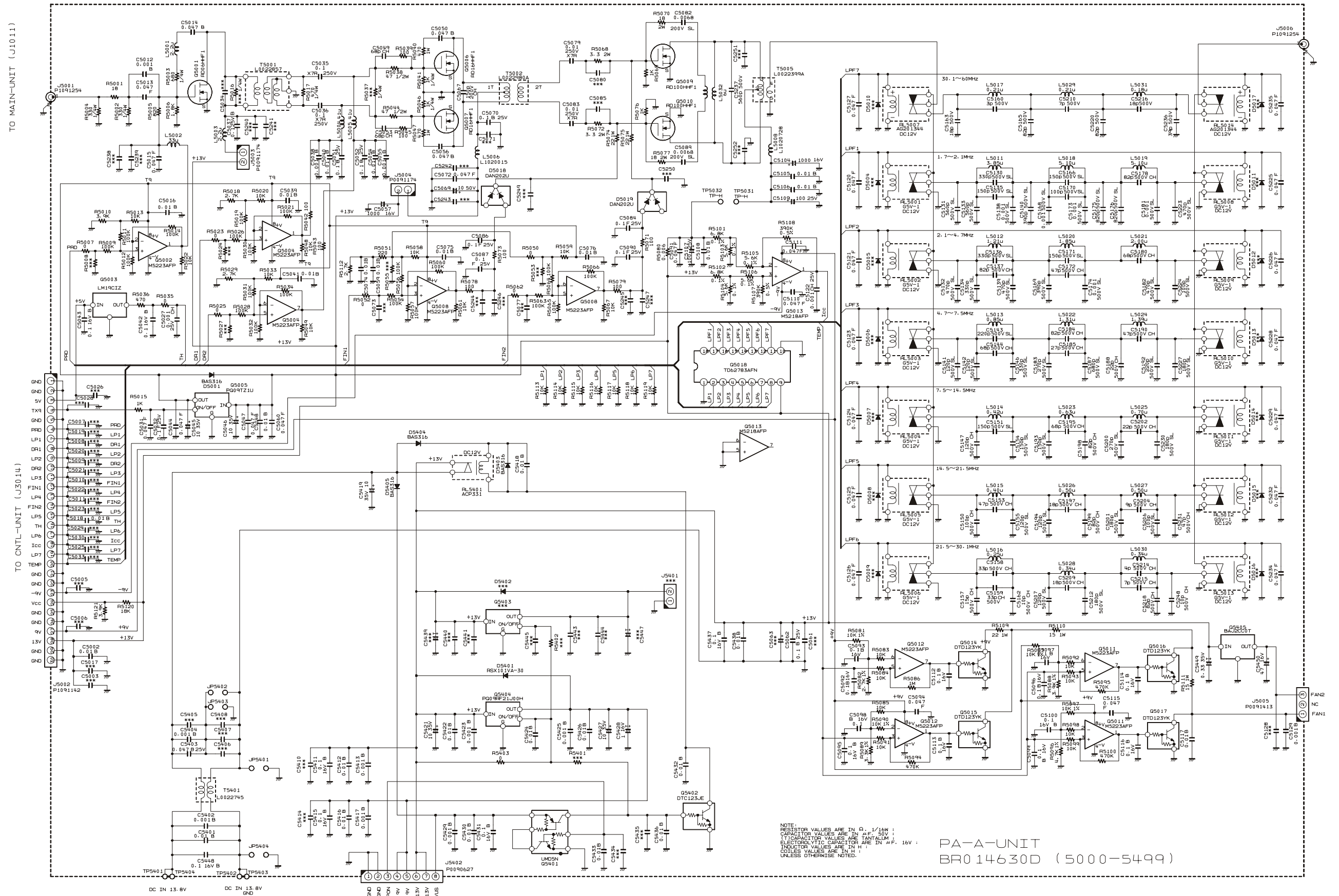

NOTE:
RESISTOR VALUES ARE IN Ω, K, M, 1/16W
CAPACITOR VALUES ARE IN pF, nF, μF, 50V
ELECTROLYTIC CAPACITORS IN μF, 50V
COLOR CODES FOR RESISTORS ARE IN A.P.P.
COLOR CODES FOR CAPACITORS ARE IN A.P.P.
UNLESS OTHERWISE NOTED.

PA-A-UNIT
BR014630D (5000-5499)

PA-A Unit

Note

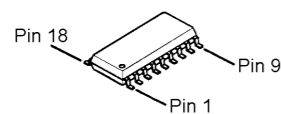

TD62783AFN
(Q5018)

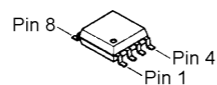

M5223AFP 600C
(Q5002, 5004, 5008,
5011, 5012)

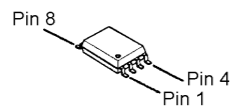

M5218AFP
(Q5013)

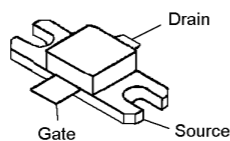

RD100HHF1
(Q5009, 5010)

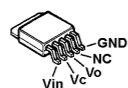

PQ09TZ1U
(Q5005)

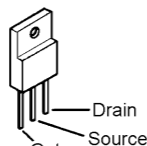

RD06HHF
(Q5001)

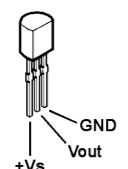

LM19CIZ
(Q5003)

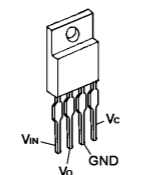

PQ09RF21
(Q5404)

PQ12DZ5UJ00H (Lot.5-)
(Q5003)

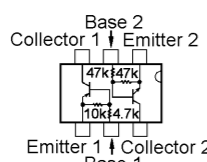

UMD5N
(Q5401)

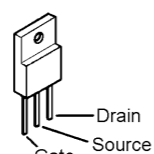

RD16HHF1
(Q5006, 5007)

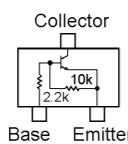

DTD123YK (F62)
(Q5014, 5015, 5016,
5017)

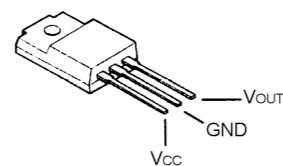

BAJ2CC0T (Lot.1-4)
(Q5405)

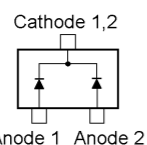

DAN202U (N)
(D5018, 5019)

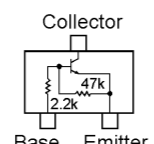

DTC123JE (E42)
(Q5402)

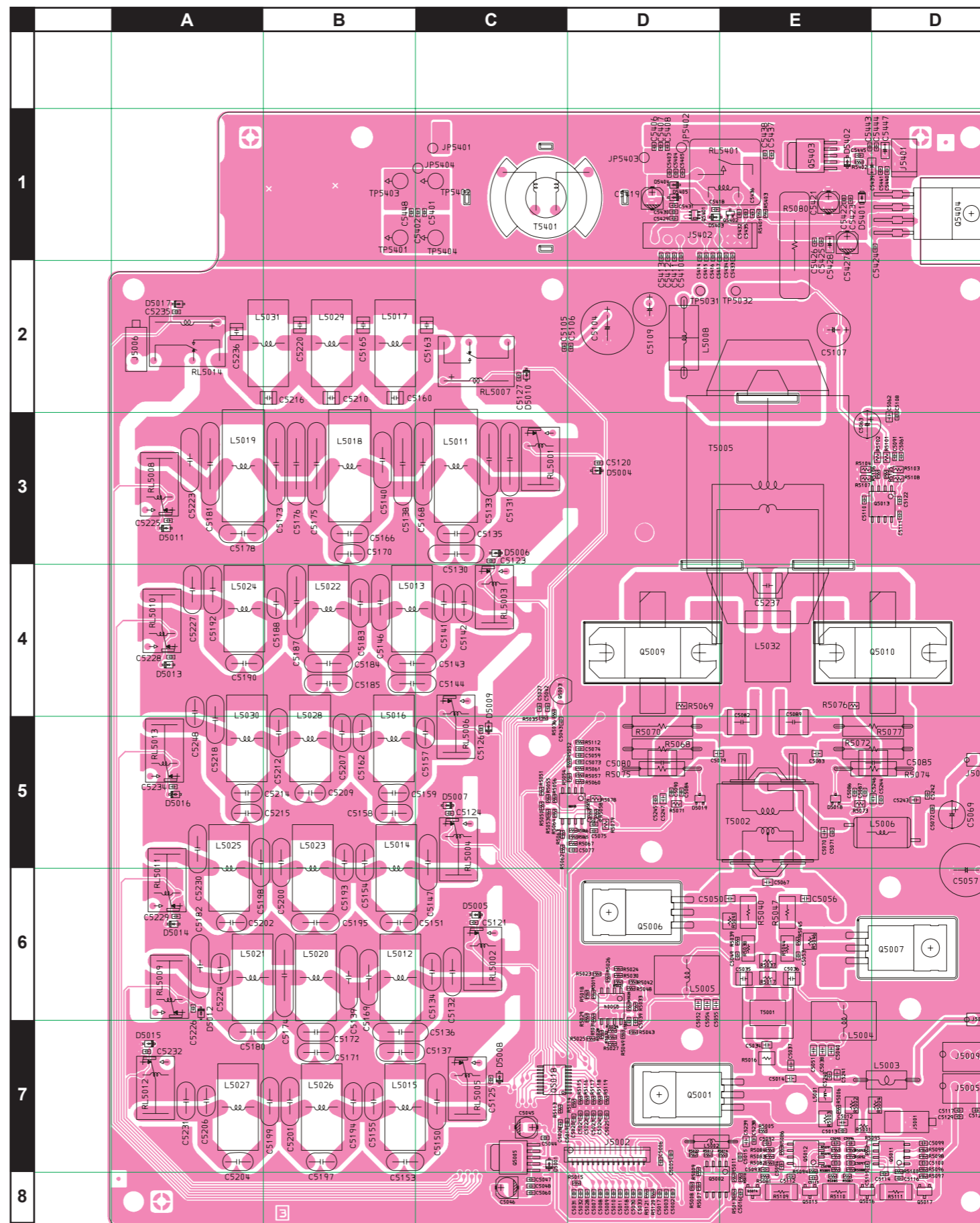

PA-A Unit

Parts Layout (Side B)

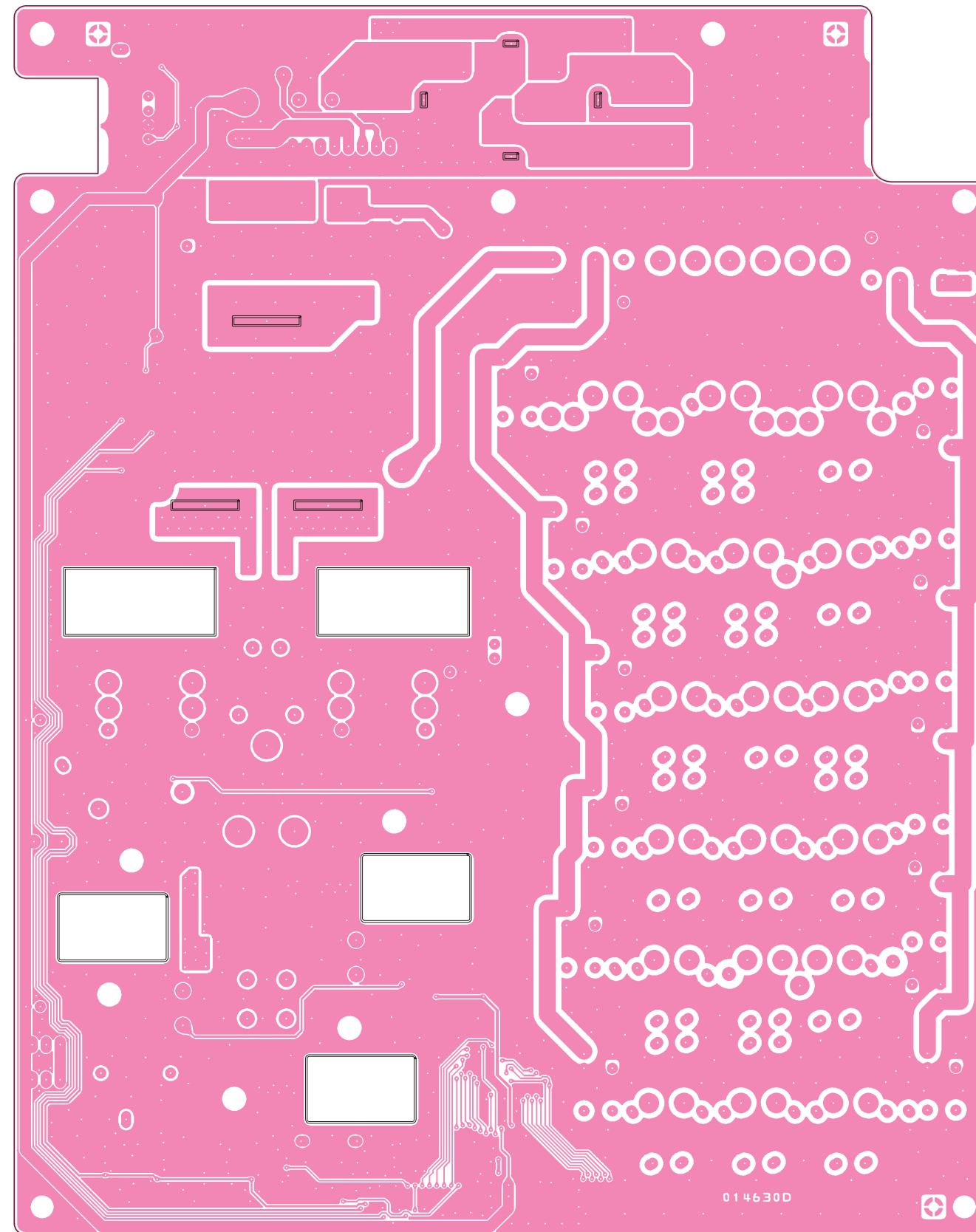

REF	DESCRIPTION	VALUE	V/W	TOL.	MFR'S DESIG	VXSTD P/N	VERS.	LOT	SIDE	LAY ADR
PCB with Components						CS1968001				
Printed Circuit Board						FR014630D		1-		
C 5002	CHIP CAP.	0.01uF	50V	B	GRM188B11H103KA01D	K22174823		1-	A	D7
C 5012	CHIP CAP.	0.001uF	50V	B	GRM216B11H102KA01D	K22170825		1-	A	E7
C 5013	CHIP CAP.	0.047uF	50V	F	GRM188F11H473ZA01D	K22175001		1-	A	E7
C 5014	CHIP CAP.	0.047uF	50V	B	GRM21BB11H473KA01L	K22170823		1-	A	E7
C 5015	CHIP CAP.	0.047uF	50V	F	GRM188F11H473ZA01D	K22175001		1-	A	E7
C 5016	CHIP CAP.	0.01uF	50V	B	GRM188B11H103KA01D	K22174823		1-	A	E7
C 5018	CHIP CAP.	0.01uF	50V	B	GRM188B11H103KA01D	K22174823		1-	A	D7
C 5027	CHIP CAP.	0.001uF	25V	CH	GRM1882C1E102JA01D	K22144204		1-	A	C4
C 5031	CHIP CAP.	0.047uF	50V	F	GRM188F11H473ZA01D	K22175001		1-	A	D7
C 5032	CHIP CAP.	0.1uF	25V	F	GRM188F11E104ZA01D	K22145001		1-	A	D7
C 5035	CHIP CAP.	0.1uF	250V	X7R	GRM32DR72E104KW01L	K22245801		1-	A	E6
C 5036	CHIP CAP.	0.1uF	250V	X7R	GRM32DR72E104KW01L	K22245801		1-	A	E6
C 5037	CHIP CAP.	0.1uF	25V	B	GRM21BB11E104KA01L	K22140811		1-	A	E7
C 5038	CHIP CAP.	0.001uF	50V	B	GRM216B11H102KA01D	K22170825		1-	A	E6
C 5039	CHIP CAP.	0.01uF	50V	B	GRM188B11H103KA01D	K22174823		1-	A	D6
C 5040	CHIP CAP.	0.01uF	50V	B	GRM40B103K50PT	K22170826		1-	A	E6
C 5041	CHIP CAP.	0.01uF	50V	B	GRM188B11H103KA01D	K22174823		1-	A	D6
C 5042	CHIP CAP.	0.1uF	16V	B	GRM188B11C104KA01D	K22124805		1-	A	C4
C 5043	CHIP CAP.	0.1uF	16V	B	GRM188B11C104KA01D	K22124805		1-	A	C4
C 5044	CHIP CAP.	0.047uF	50V	F	GRM188F11H473ZA01D	K22175001		1-	A	C7
C 5045	AL.ELECTRO.CAP.	10uF	35V		EEE1VA100WR	K48160006		1-	A	C7
C 5046	AL.ELECTRO.CAP.	10uF	35V		EEE1VA100WR	K48160006		1-	A	C7
C 5047	CHIP CAP.	0.047uF	50V	F	GRM188F11H473ZA01D	K22175001		1-	A	C7
C 5048	CHIP CAP.	0.01uF	50V	B	GRM188B11H103KA01D	K22174823		1-	A	C7
C 5049	CHIP CAP.	68pF	50V	CH	GRM1882C1H680JA01D	K22174231		1-	A	E6
C 5050	CHIP CAP.	0.047uF	50V	B	GRM21BB11H473KA01L	K22170823		1-	A	E5
C 5051	CHIP CAP.	0.1uF	25V	B	GRM21BB11E104KA01L	K22140811		1-	A	E6
C 5052	CHIP CAP.	0.1uF	25V	B	GRM21BB11E104KA01L	K22140811		1-	A	D6
C 5053	CHIP CAP.	68pF	50V	CH	GRM1882C1H680JA01D	K22174231		1-	A	E6
C 5054	CHIP CAP.	0.01uF	50V	B	GRM40B103K50PT	K22170826		1-	A	D6
C 5055	CHIP CAP.	0.001uF	50V	B	GRM216B11H102KA01D	K22170825		1-	A	D6
C 5056	CHIP CAP.	0.047uF	50V	B	GRM21BB11H473KA01L	K22170823		1-	A	E5
C 5057	AL.ELECTRO.CAP.	1000uF	16V		RE3-16V102MH3#	K40129096		1-	A	F5
C 5059	CHIP CAP.	0.01uF	50V	B	GRM188B11H103KA01D	K22174823		1-	A	D5
C 5060	CHIP CAP.	0.047uF	50V	F	GRM188F11H473ZA01D	K22175001		1-	A	C7
C 5062	CHIP CAP.	0.1uF	25V	B	GRM21BB11E104KA01L	K22140811		1-	A	F2
C 5067	CHIP CAP.	150pF	200V	CH	GRM21B2C2D151JV01L	K22230230		1-	A	E5
C 5069	AL.ELECTRO.CAP.	10uF	50V		RE2-50V100ME3#-T2	K46170021		1-	A	F5
C 5070	CHIP CAP.	0.1uF	25V	B	GRM21BB11E104KA01L	K22140811		1-	A	E5
C 5072	CHIP CAP.	0.047uF	50V	F	GRM188F11H473ZA01D	K22175001		1-	A	F5
C 5074	CHIP CAP.	0.01uF	50V	B	GRM188B11H103KA01D	K22174823		1-	A	D4
C 5075	CHIP CAP.	0.01uF	50V	B	GRM188B11H103KA01D	K22174823		1-	A	D5
C 5076	CHIP CAP.	0.01uF	50V	B	GRM188B11H103KA01D	K22174823		1-	A	D5
C 5079	CHIP CAP.	0.01uF	250V	X7R	GRM21BR72E103KW03L	K22240801		1-	A	E4
C 5082	CERAMIC CAP.	0.0068uF	200V	SL	GRM55R1X2D682JV01L	K22236101		1-	A	E4
C 5083	CHIP CAP.	0.01uF	250V	X7R	GRM21BR72E103KW03L	K22240801		1-	A	E4
C 5084	CHIP CAP.	0.1uF	25V	F	GRM188F11E104ZA01D	K22145001		1-	A	D5
C 5086	CHIP CAP.	0.1uF	25V	F	GRM188F11E104ZA01D	K22145001		1-	A	E5
C 5087	CHIP CAP.	0.1uF	25V	F	GRM188F11E104ZA01D	K22145001		1-	A	E5
C 5089	CERAMIC CAP.	0.0068uF	200V	SL	GRM55R1X2D682JV01L	K22236101		1-	A	E4
C 5090	CHIP CAP.	0.1uF	25V	F	GRM188F11E104ZA01D	K22145001		1-	A	D5
C 5091	CHIP CAP.	0.047uF	50V	F	GRM188F11H473ZA01D	K22175001		1-	A	F3
C 5092	CHIP CAP.	0.1uF	16V	B	GRM188B11C104KA01D	K22124805		1-	A	E7
C 5093	CHIP CAP.	0.1uF	16V	B	GRM188B11C104KA01D	K22124805		1-	A	E7
C 5094	CHIP CAP.	0.047uF	50V	F	GRM188F11H473ZA01D	K22175001		1-	A	E7
C 5095	CHIP CAP.	0.1uF	16V	B	GRM188B11C104KA01D	K22124805		1-	A	E7
C 5096	CHIP CAP.	0.1uF	16V	B	GRM188B11C104KA01D	K22124805		1-	A	E7
C 5097	CHIP CAP.	0.1uF	16V	B	GRM188B11C104KA01D	K22124805		1-	A	E7
C 5098	CHIP CAP.	0.1uF	16V	B	GRM188B11C104KA01D	K22124805		1-	A	E7
C 5099	CHIP CAP.	0.1uF	16V	B	GRM188B11C104KA01D	K22124805		1-	A	F7
C 5100	CHIP CAP.	0.1uF	16V	B	GRM188B11C104KA01D	K22124805		1-	A	F7
C 5104	AL.ELECTRO.CAP.	1000uF	16V		RE3-16V102MH3#	K40129096		1-	A	D2
C 5105	CHIP CAP.	0.01uF	50V	B	GRM188B11H103KA01D	K22174823		1-	A	C2
C 5106	CHIP CAP.	0.01uF	50V	B	GRM188B11H103KA01D	K22174823		1-	A	D2
C 5107	AL.ELECTRO.CAP.	100uF	25V		RE2-25V101MH3#	K40149028		1-	A	E2
C 5108	CHIP CAP.	0.01uF	50V	B	GRM188B11H103KA01D	K22174823		1-	A	F3
C 5109	AL.ELECTRO.CAP.	100uF	25V		RE2-25V101MH3#	K40149028		1-	A	D2
C 5110	CHIP CAP.	0.047uF	50V	F	GRM188F11H473ZA01D	K22175001		1-	A	E3
C 5111	CHIP CAP.	0.047uF	50V	F	GRM188F11H473ZA01D	K22175001		1-	A	F3
C 5112	CHIP CAP.	0.1uF	16V	B	GRM188B11C104KA01D	K22124805		1-	A	E7
C 5113	CHIP CAP.	0.1uF	16V	B	GRM188B11C104KA01D	K22124805		1-	A	E7

PA-A Unit

Parts List

REF	DESCRIPTION	VALUE	V/W	TOL.	MFR'S DESIG	VXSTD P/N	VERS.	LOT	SIDE	LAY ADR
C 5114	CHIP CAP.	0.1uF	16V	B	GRM188B11C104KA01D	K22124805		1-	A	F7
C 5115	CHIP CAP.	0.047uF	50V	F	GRM188F11H473ZA01D	K22175001		1-	A	E7
C 5116	CHIP CAP.	0.1uF	16V	B	GRM188B11C104KA01D	K22124805		1-	A	F7
C 5117	CHIP CAP.	0.01uF	50V	B	GRM188B11H103KA01D	K22174823		1-	A	F7
C 5120	CHIP CAP.	0.047uF	50V	F	GRM188F11H473ZA01D	K22175001		1-	A	D3
C 5121	CHIP CAP.	0.047uF	50V	F	GRM188F11H473ZA01D	K22175001		1-	A	C6
C 5122	CHIP CAP.	0.001uF	25V	CH	GRM1882C1E102JA01D	K22144204		1-	A	F3
C 5123	CHIP CAP.	0.047uF	50V	F	GRM188F11H473ZA01D	K22175001		1-	A	C3
C 5124	CHIP CAP.	0.047uF	50V	F	GRM188F11H473ZA01D	K22175001		1-	A	C5
C 5125	CHIP CAP.	0.047uF	50V	F	GRM188F11H473ZA01D	K22175001		1-	A	C7
C 5126	CHIP CAP.	0.047uF	50V	F	GRM188F11H473ZA01D	K22175001		1-	A	C4
C 5127	CHIP CAP.	0.047uF	50V	F	GRM188F11H473ZA01D	K22175001		1-	A	C2
C 5129	CHIP CAP.	0.001uF	50V	B	GRM188B11H102KA01D	K22174821		1-	A	F7
C 5130	CERAMIC CAP.	330pF	500V	SL	RT-HM11SKSL331J	K26270063		1-	A	C3
C 5131	CERAMIC CAP.	560pF	500V	SL	HM15SJSL561J	K00279025		1-	A	C2
C 5132	CERAMIC CAP.	470pF	500V	SL	HM13SJSL471J	K00279024		1-	A	C6
C 5133	CERAMIC CAP.	560pF	500V	SL	HM15SJSL561J	K00279025		1-	A	C2
C 5134	CERAMIC CAP.	330pF	500V	SL	RT-HM11SKSL331J	K26270063		1-	A	C6
C 5135	CERAMIC CAP.	150pF	500V	SL	RT-HM74SKSL151J	K26270059		1-	A	C3
C 5136	CERAMIC CAP.	330pF	500V	SL	RT-HM11SKSL331J	K26270063		1-	A	B6
C 5137	CERAMIC CAP.	82pF	500V	CH	RT-HM95SKCH820J	K26270162		1-	A	B6
C 5138	CERAMIC CAP.	0.001uF	500V	SL	HM17SJSL102J	K00279028		1-	A	B3
C 5139	CERAMIC CAP.	470pF	500V	SL	HM13SJSL471J	K00279024		1-	A	B6
C 5140	CERAMIC CAP.	390pF	500V	SL	RT-HM11SKSL391J	K26270064		1-	A	B2
C 5141	CERAMIC CAP.	120pF	500V	SL	RT-HM74SKSL121J	K26270058		1-	A	C3
C 5142	CERAMIC CAP.	120pF	500V	SL	RT-HM74SKSL121J	K26270058		1-	A	C3
C 5143	CERAMIC CAP.	220pF	500V	SL	RT-HM95SKSL221J	K26270061		1-	A	C4
C 5144	CERAMIC CAP.	68pF	500V	CH	RT-HM95SKCH680J	K26270161		1-	A	C4
C 5146	CERAMIC CAP.	330pF	500V	SL	RT-HM11SKSL331J	K26270063		1-	A	B3
C 5147	CERAMIC CAP.	120pF	500V	CH	RT-HM11SKCH121J	K26270164		1-	A	C5
C 5150	CERAMIC CAP.	100pF	500V	CH	RT-HM11SKCH101J	K26270163		1-	A	C7
C 5151	CERAMIC CAP.	150pF	500V	SL	RT-HM74SKSL151J	K26270059		1-	A	B6
C 5153	CERAMIC CAP.	47pF	500V	CH	RT-HM74SKCH470J	K26270159		1-	A	C7
C 5154	CERAMIC CAP.	150pF	500V	SL	RT-HM74SKSL151J	K26270059		1-	A	B5
C 5155	CERAMIC CAP.	120pF	500V	SL	RT-HM74SKSL121J	K26270058		1-	A	B7
C 5157	CERAMIC CAP.	15pF	500V	CH	RT-HM60SKCH150J	K26270153		1-	A	C4
C 5158	CERAMIC CAP.	33pF	500V	CH	RT-HM74SKCH330J	K26270157		1-	A	B5
C 5159	CERAMIC CAP.	33pF	500V	CH	RT-HM74SKCH330J	K26270157		1-	A	B5
C 5160	FILM CAP.	3pF	500V		UC232H0030D-T	K33279027		1-	A	B2
C 5162	CERAMIC CAP.	10pF	500V	CH	RT-HM60SKCH100D	K26270151		1-	A	B4
C 5163	FILM CAP.	18pF	500V		UC232H0180J-T	K33279029		1-	A	C2
C 5165	FILM CAP.	82pF	500V		UC232H0820J-T	K33279033		1-	A	B2
C 5166	CERAMIC CAP.	150pF	500V	SL	RT-HM74SKSL151J	K26270059		1-	A	B3
C 5168	CERAMIC CAP.	0.001uF	500V	SL	HM17SJSL102J	K00279028		1-	A	C3
C 5169	CERAMIC CAP.	390pF	500V	SL	RT-HM11SKSL391J	K26270064		1-	A	B6
C 5170	CERAMIC CAP.	100pF	500V	SL	RT-HM60SKSL101J	K26270057		1-	A	B3
C 5171	CERAMIC CAP.	150pF	500V	SL	RT-HM74SKSL151J	K26270059		1-	A	B6
C 5172	CERAMIC CAP.	47pF	500V	CH	RT-HM74SKCH470J	K26270159		1-	A	B6
C 5173	CERAMIC CAP.	0.001uF	500V	SL	HM17SJSL102J	K00279028		1-	A	B2
C 5174	CERAMIC CAP.	0.001uF	500V	SL	HM17SJSL102J	K00279028		1-	A	B6
C 5175	CERAMIC CAP.	820pF	500V	SL	HM17SJSL821J	K00279027		1-	A	B2
C 5176	CERAMIC CAP.	820pF	500V	SL	HM17SJSL821J	K00279027		1-	A	B2
C 5178	CERAMIC CAP.	82pF	500V	CH	RT-HM95SKCH820J	K26270162		1-	A	A3
C 5180	CERAMIC CAP.	68pF	500V	CH	RT-HM95SKCH680J	K26270161		1-	A	B6
C 5181	CERAMIC CAP.	0.001uF	500V	SL	HM17SJSL102J	K00279028		1-	A	A2
C 5182	CERAMIC CAP.	470pF	500V	SL	HM13SJSL471J	K00279024		1-	A	A6
C 5183	CERAMIC CAP.	270pF	500V	SL	RT-HM95SKSL271J	K26270062		1-	A	B3
C 5184	CERAMIC CAP.	82pF	500V	CH	RT-HM95SKCH820J	K26270162		1-	A	B4
C 5185	CERAMIC CAP.	27pF	500V	CH	RT-HM60SKCH270J	K26270156		1-	A	B4
C 5187	CERAMIC CAP.	680pF	500V	SL	HM15SJSL681J	K00279026		1-	A	B3
C 5188	CERAMIC CAP.	22pF	500V	CH	RT-HM60SKCH220J	K26270155		1-	A	B3
C 5190	CERAMIC CAP.	47pF	500V	CH	RT-HM74SKCH470J	K26270159		1-	A	A4
C 5192	CERAMIC CAP.	220pF	500V	SL	RT-HM95SKSL221J	K26270061		1-	A	A3
C 5193	CERAMIC CAP.	150pF	500V	SL	RT-HM74SKSL151J	K26270059		1-	A	B5
C 5194	CERAMIC CAP.	120pF	500V	SL	RT-HM74SKSL121J	K26270058		1-	A	B7
C 5195	CERAMIC CAP.	68pF	500V	CH	RT-HM95SKCH680J	K26270161		1-	A	B6
C 5197	CERAMIC CAP.	18pF	500V	CH	RT-HM60SKCH180J	K26270154		1-	A	B7
C 5198	CERAMIC CAP.	82pF	500V	CH	RT-HM95SKCH820J	K26270162		1-	A	A5
C 5199	CERAMIC CAP.	82pF	500V	CH	RT-HM95SKCH820J	K26270162		1-	A	B7
C 5200	CERAMIC CAP.	270pF	500V	SL	RT-HM95SKSL271J	K26270062		1-	A	B5
C 5201	CERAMIC CAP.	180pF	500V	SL	RT-HM95SKSL181J	K26270060		1-	A	B7
C 5202	CERAMIC CAP.	22pF	500V	CH	RT-HM60SKCH220J	K26270155		1-	A	A6
C 5204	CERAMIC CAP.	9pF	500V	CH	RT-HM60SKCH090D	K26270150		1-	A	A7

REF	DESCRIPTION	VALUE	V/W	TOL.	MFR'S DESIG	VXSTD P/N	VERS.	LOT	SIDE	LAY ADR
C 5206	CERAMIC CAP.	100pF	500V	SL	RT-HM60SKSL101J	K26270057		1-	A	A7
C 5207	CERAMIC CAP.	120pF	500V	SL	RT-HM74SKSL121J	K26270058		1-	A	B4
C 5209	CERAMIC CAP.	18pF	500V	CH	RT-HM60SKCH180J	K26270154		1-	A	B5
C 5210	FILM CAP.	7pF	500V		UC232H0070D-T	K33279046		1-	A	B2
C 5212	CERAMIC CAP.	180pF	500V	SL	RT-HM95SKSL181J	K26270060		1-	A	B4
C 5214	CERAMIC CAP.	4pF	500V	CH	RT-HM60SKCH040C	K26270145		1-	A	A5
C 5215	CERAMIC CAP.	7pF	500V	CH	RT-HM60SKCH070D	K26270148		1-	A	A5
C 5216	FILM CAP.	18pF	500V		UC232H0180J-T	K33279029		1-	A	B2
C 5218	CERAMIC CAP.	82pF	500V	CH	RT-HM95SKCH820J	K26270162		1-	A	A4
C 5220	FILM CAP.	82pF	500V		UC232H0820J-T	K33279033		1-	A	B2
C 5223	CERAMIC CAP.	470pF	500V	SL	HM13SJSJL471J	K00279024		1-	A	A2
C 5224	CERAMIC CAP.	100pF	500V	SL	RT-HM60SKSL101J	K26270057		1-	A	A6
C 5225	CHIP CAP.	0.047uF	50V	F	GRM188F11H473ZA01D	K22175001		1-	A	A3
C 5226	CHIP CAP.	0.047uF	50V	F	GRM188F11H473ZA01D	K22175001		1-	A	A6
C 5227	CERAMIC CAP.	180pF	500V	SL	RT-HM95SKSL181J	K26270060		1-	A	A3
C 5228	CHIP CAP.	0.047uF	50V	F	GRM188F11H473ZA01D	K22175001		1-	A	A4
C 5229	CHIP CAP.	0.047uF	50V	F	GRM188F11H473ZA01D	K22175001		1-	A	A6
C 5230	CERAMIC CAP.	180pF	500V	SL	RT-HM95SKSL181J	K26270060		1-	A	A5
C 5231	CERAMIC CAP.	47pF	500V	CH	RT-HM74SKCH470J	K26270159		1-	A	A7
C 5232	CHIP CAP.	0.047uF	50V	F	GRM188F11H473ZA01D	K22175001		1-	A	A6
C 5234	CHIP CAP.	0.047uF	50V	F	GRM188F11H473ZA01D	K22175001		1-	A	A5
C 5235	CHIP CAP.	0.047uF	50V	F	GRM188F11H473ZA01D	K22175001		1-	A	A2
C 5236	FILM CAP.	39pF	500V		UC232H0390J-T	K33279038		1-	A	A2
C 5237	FILM CAP.	560pF	500V		UC552H5600J-T	K33279041		1-	A	E3
C 5248	CERAMIC CAP.	10pF	500V	CH	RT-HM60SKCH100D	K26270151		1-	A	A4
C 5401	CHIP CAP.	0.01uF	50V	B	GRM188B11H103KA01D	K22174823		1-	A	C1
C 5402	CHIP CAP.	0.001uF	50V	B	GRM188B11H102KA01D	K22174821		1-	A	C1
C 5403	CHIP CAP.	0.047uF	25V	B	GRM188B11E473KA01D	K22144811		1-	A	D1
C 5404	CHIP CAP.	0.001uF	50V	B	GRM188B11H102KA01D	K22174821		1-	A	D1
C 5411	CHIP CAP.	0.1uF	16V	B	GRM188B11C104KA01D	K22124805		1-	A	D1
C 5412	CHIP CAP.	0.01uF	50V	B	GRM188B11H103KA01D	K22174823		1-	A	D1
C 5413	CHIP CAP.	0.001uF	50V	B	GRM188B11H102KA01D	K22174821		1-	A	D1
C 5415	CHIP CAP.	0.1uF	16V	B	GRM188B11C104KA01D	K22124805		1-	A	D1
C 5416	CHIP CAP.	0.01uF	50V	B	GRM188B11H103KA01D	K22174823		1-	A	D1
C 5417	CHIP CAP.	0.001uF	50V	B	GRM188B11H102KA01D	K22174821		1-	A	E1
C 5418	CHIP CAP.	0.01uF	50V	B	GRM188B11H103KA01D	K22174823		1-	A	D1
C 5419	AL.ELECTRO.CAP.	10uF	35V		EEE1VA100WR	K48160006		1-	A	D1
C 5421	AL.ELECTRO.CAP.	10uF	35V		EEE1VA100WR	K48160006		1-	A	E1
C 5422	CHIP CAP.	0.01uF	50V	B	GRM188B11H103KA01D	K22174823		1-	A	E1
C 5423	CHIP CAP.	0.001uF	50V	B	GRM188B11H102KA01D	K22174821		1-	A	E1
C 5424	CHIP CAP.	0.01uF	50V	B	GRM188B11H103KA01D	K22174823		1-	A	F1
C 5425	CHIP CAP.	0.001uF	50V	B	GRM188B11H102KA01D	K22174821		1-	A	E1
C 5426	CHIP CAP.	0.01uF	50V	B	GRM188B11H103KA01D	K22174823		1-	A	E1
C 5427	AL.ELECTRO.CAP.	10uF	35V		EEE1VA100WR	K48160006		1-	A	E1
C 5428	CHIP TA.CAP.	1uF	16V		TEESVA1C105M8R	K78120009		1-	A	E1
C 5429	CHIP CAP.	0.001uF	50V	B	GRM188B11H102KA01D	K22174821		1-	A	D1
C 5430	CHIP CAP.	0.01uF	50V	B	GRM188B11H103KA01D	K22174823		1-	A	D1
C 5431	CHIP CAP.	0.1uF	16V	B	GRM188B11C104KA01D	K22124805		1-	A	D1
C 5432	CHIP CAP.	0.01uF	50V	B	GRM188B11H103KA01D	K22174823		1-	A	E1
C 5433	CHIP CAP.	0.01uF	50V	B	GRM188B11H103KA01D	K22174823		1-	A	E1
C 5436	CHIP CAP.	0.01uF	50V	B	GRM188B11H103KA01D	K22174823		1-	A	E1
C 5437	CHIP CAP.	0.1uF	16V	B	GRM188B11C104KA01D	K22124805		1-	A	E1
C 5438	CHIP CAP.	0.01uF	50V	B	GRM188B11H103KA01D	K22174823		1-	A	E1
C 5439	CHIP TA.CAP.	0.33uF	35V		TEESVA1V334M8R	K78160028		5-	A	F1
C 5440	CHIP CAP.	0.01uF	50V	B	GRM188B11H103KA01D	K22174823		5-	A	F1
C 5441	CHIP CAP.	0.001uF	50V	B	GRM188B11H102KA01D	K22174821		5-	A	F1
C 5443	CHIP CAP.	0.001uF	50V	B	GRM188B11H102KA01D	K22174821		5-	A	E1
C 5444	CHIP CAP.	0.01uF	50V	B	GRM188B11H103KA01D	K22174823		5-	A	F1
C 5445	CHIP CAP.	0.01uF	50V	B	GRM188B11H103KA01D	K22174823		5-	A	E1
C 5448	CHIP CAP.	0.1uF	16V	B	GRM188B11C104KA01D	K22124805		1-	A	B1
C 5449	TANTALUM CAP.	0.33uF	35V		TPDN1VR33M8S(MX0)	K76160018		1-4		
C 5450	AL.ELECTRO.CAP.	47uF	16V		RE2-16V470ME3#	K40129054		1-		
C 5451	AL.ELECTRO.CAP.	47uF	16V		RE2-16V470ME3#	K40129054		5-		
D 5001	DIODE				BAS316	G2070716		1-	A	C7
D 5018	DIODE				DAN202U T106	G2070162		1-	A	E5
D 5019	DIODE				DAN202U T106	G2070162		1-	A	D5
D 5401	DIODE				RSX101VA-30TR	G2070984		1-	A	E1
D 5403	DIODE				BAS316	G2070716		1-	A	D1
D 5404	DIODE				BAS316	G2070716		1-	A	D1
D 5405	DIODE				BAS316	G2070716		1-	A	D1
J 5001	CONNECTOR				TMP-S01X-C1	P1091254		1-	A	F7
J 5002	CONNECTOR				30FLT-SM2-TB(LF)(SN)(M)	P1091142		1-	A	D7
J 5003	CONNECTOR				IMSA-9202B-1-02-T	P0091174		1-	A	F6

PA-A Unit

Parts List

REF	DESCRIPTION	VALUE	V/W	TOL.	MFR'S DESIG	VXSTD P/N	VERS.	LOT	SIDE	LAY ADR
J 5004	CONNECTOR				IMSA-9202B-1-02-T	P0091174		1-	A	F5
J 5005	CONNECTOR				B3B-XH-A(LF)(SN)	P0091413		1-	A	F7
J 5006	CONNECTOR				TMP-S01X-C1	P1091254		1-	A	A2
J 5402	CONNECTOR				SC25-08WS	P0090627		1-	A	E1
JP5001	WIRE ASSY				GRN 20 2/2	T50502000		1-4		
L 5001	CHIP COIL	2.2uH		10%	C2520C-2R2K-RK	L1690731		1-	A	E7
L 5002	M.RFC	33uH			LAL03TA330K	L1790101		1-	A	D7
L 5003	M.RFC	2.2uH			LAL04NA2R2M	L1190319		1-	A	F7
L 5004	TOROIDAL COIL	41uH			41.00U 3A FR9.5°5	L0021432		1-	A	E6
L 5005	TOROIDAL COIL	41uH			41.00U 3A FR9.5°5	L0021432		1-	A	D6
L 5006	RFC WITH BEADS				FB-43-5111	L1020015		1-	A	F5
L 5008	RFC WITH BEADS				3A RI5.8X6.4-2	L1020728		1-	A	D2
L 5008	RFC WITH BEADS				3A RI5.8X6.4-2	L1020728A		6-	A	D2
L 5011	TOROIDAL COIL	3.85uH			3.85U T68-2	L0022963		1-	A	C3
L 5012	TOROIDAL COIL	1.21uH			1.21U T50-2	L0022965		1-	A	C6
L 5013	TOROIDAL COIL	0.85uH			0.85U T50-6	L0022968		1-	A	C4
L 5014	TOROIDAL COIL	0.42uH			0.42U T50-6	L0022971		1-	A	B5
L 5015	TOROIDAL COIL	0.4uH			0.40U T50-6	L0022974		1-	A	C7
L 5016	TOROIDAL COIL	0.25uH			0.25U T50-6	L0022976		1-	A	B4
L 5017	TOROIDAL COIL	0.21uH			0.21U T50-10	L0022979		1-	A	B2
L 5018	TOROIDAL COIL	5.1uH			5.10U T68-2	L0022964		1-	A	B3
L 5019	TOROIDAL COIL	5.1uH			5.10U T68-2	L0022964		1-	A	A3
L 5020	TOROIDAL COIL	1.85uH			1.85U T50-2	L0022966		1-	A	B6
L 5021	TOROIDAL COIL	2uH			2.00U T50-2	L0022967		1-	A	B6
L 5022	TOROIDAL COIL	1.31uH			1.31U T50-6	L0022969		1-	A	B4
L 5023	TOROIDAL COIL	0.63uH			0.63U T50-6	L0022972		1-	A	B5
L 5024	TOROIDAL COIL	1.39uH			1.39U T50-6	L0022970		1-	A	A4
L 5025	TOROIDAL COIL	0.7uH			0.70U T50-6	L0022973		1-	A	A5
L 5026	TOROIDAL COIL	0.5uH			0.50U T50-6	L0022975		1-	A	B7
L 5027	TOROIDAL COIL	0.5uH			0.50U T50-6	L0022975		1-	A	A7
L 5028	TOROIDAL COIL	0.34uH			0.34U T50-6	L0022977		1-	A	B4
L 5029	TOROIDAL COIL	0.21uH			0.21U T50-10	L0022979		1-	A	B2
L 5030	TOROIDAL COIL	0.34uH			0.34U T50-6	L0022977		1-	A	B4
L 5031	TOROIDAL COIL	0.18uH			0.18U T50-10	L0022978		1-	A	B2
L 5032	TOROIDAL COIL	6uH			U 6H3 10X5X5	L0022039		1-	A	E4
P 5001	CONNECTOR				IMSA-9206H-T	P1090988		1-		
P 5002	CONNECTOR				IMSA-9206H-T	P1090988		1-		
P 5003	TERMINAL				B4 AG M3	Q6000114		1-		
P 5004	WIRE ASSY				AH025H 110MM	T9207317		1-		
Q 5001	FET				RD06HHF1-01	G3090145		1-	A	D7
Q 5002	IC				M5223AFP 600C	G1092955		1-	A	D7
Q 5003	IC				LM19CIZ	G1094150		1-	A	C4
Q 5004	IC				M5223AFP 600C	G1092955		1-	A	D6
Q 5005	IC				PQ09TZ1U	G1092599		1-	A	C7
Q 5006	FET				RD16HHF1	G3090148		1-	A	D6
Q 5007	FET				RD16HHF1	G3090148		1-	A	F6
Q 5008	IC				M5223AFP 600C	G1092955		1-	A	D5
Q 5009	FET				RD100HHF1-101	G3090151		1-	A	D4
Q 5010	FET				RD100HHF1-101	G3090151		1-	A	F4
Q 5011	IC				M5223AFP 600C	G1092955		1-	A	F7
Q 5012	IC				M5223AFP 600C	G1092955		1-	A	E7
Q 5013	IC				M5218AFP-600C	G1091607		1-	A	F3
Q 5014	TRANSISTOR				DTD123YK T146	G3070157		1-	A	E7
Q 5015	TRANSISTOR				DTD123YK T146	G3070157		1-	A	E7
Q 5016	TRANSISTOR				DTD123YK T146	G3070157		1-	A	E7
Q 5017	TRANSISTOR				DTD123YK T146	G3070157		1-	A	F7
Q 5018	IC				TD62783AFNG(5.S.EL)	G1092700		1-	A	C7
Q 5401	TRANSISTOR				UMD5N TR	G3070343		1-	A	D1
Q 5402	TRANSISTOR				DTC123JE TL	G3070323		1-	A	E1
Q 5403	IC				PQ12DZ5UJ00H	G1094579		5-	A	E1
Q 5404	IC				PQ09RF21J00H	G1094351		1-	A	F1
Q 5405	IC				BAJ2CC0T	G1094173		1-4		
R 5001	CHIP RES.	18	1/4W	5%	RMC1/4 180JATP	J24245180		1-	A	E7
R 5002	CHIP RES.	330	1/4W	5%	RMC1/4 331JATP	J24245331		1-	A	E7
R 5003	CHIP RES.	680	1/4W	5%	RMC1/4 681JATP	J24245681		1-	A	E7
R 5004	CHIP RES.	330	1/4W	5%	RMC1/4 331JATP	J24245331		1-	A	F7
R 5005	CHIP RES.	820	1/16W	5%	RMC1/16 821JATP	J24185821		1-	A	E7
R 5006	CHIP RES.	1.8k	1/16W	5%	RMC1/16 182JATP	J24185182		1-	A	E7
R 5007	CHIP RES.	0	1/16W	5%	RMC1/16 000JATP	J24185000		1-	A	D7
R 5009	CHIP RES.	100k	1/16W	5%	RMC1/16 104JATP	J24185104		1-	A	D7
R 5010	CHIP RES.	3.9k	1/16W	5%	RMC1/16 392JATP	J24185392		1-	A	E7
R 5011	CHIP RES.	100k	1/16W	5%	RMC1/16 104JATP	J24185104		1-	A	E7
R 5012	CHIP RES.	100k	1/16W	5%	RMC1/16 104JATP	J24185104		1-	A	D7

PA-A Unit

Parts List

REF	DESCRIPTION	VALUE	V/W	TOL.	MFR'S DESIG	VXSTD P/N	VERS.	LOT	SIDE	LAY ADR
R 5013	CHIP RES.	10k	1/16W	5%	RMC1/16 103JATP	J24185103		1-	A	E7
R 5014	CHIP RES.	100k	1/16W	5%	RMC1/16 104JATP	J24185104		1-	A	E7
R 5015	CHIP RES.	1k	1/16W	5%	RMC1/16 102JATP	J24185102		1-	A	D7
R 5017	CHIP RES.	470	1/4W	5%	RMC1/4 471JATP	J24245471		1-	A	E6
R 5018	CHIP RES.	2.7k	1/16W	5%	RMC1/16 272JATP	J24185272		1-	A	D6
R 5019	CHIP RES.	100k	1/16W	5%	RMC1/16 104JATP	J24185104		1-	A	D6
R 5020	CHIP RES.	10k	1/16W	5%	RMC1/16 103JATP	J24185103		1-	A	D6
R 5021	CHIP RES.	100k	1/16W	5%	RMC1/16 104JATP	J24185104		1-	A	D6
R 5022	CHIP RES.	10k	1/16W	5%	RMC1/16 103JATP	J24185103		1-	A	D7
R 5023	CHIP RES.	0	1/16W	5%	RMC1/16 000JATP	J24185000		1-	A	D6
R 5025	CHIP RES.	0	1/16W	5%	RMC1/16 000JATP	J24185000		1-	A	D6
R 5026	CHIP RES.	100k	1/16W	5%	RMC1/16 104JATP	J24185104		1-	A	D6
R 5028	CHIP RES.	100k	1/16W	5%	RMC1/16 104JATP	J24185104		1-	A	D6
R 5029	CHIP RES.	2.7k	1/16W	5%	RMC1/16 272JATP	J24185272		1-	A	D6
R 5030	CHIP RES.	100k	1/16W	5%	RMC1/16 104JATP	J24185104		1-	A	D6
R 5031	CHIP RES.	100k	1/16W	5%	RMC1/16 104JATP	J24185104		1-	A	D6
R 5032	CHIP RES.	100k	1/16W	5%	RMC1/16 104JATP	J24185104		1-	A	D6
R 5033	CHIP RES.	10k	1/16W	5%	RMC1/16 103JATP	J24185103		1-	A	D6
R 5034	CHIP RES.	100k	1/16W	5%	RMC1/16 104JATP	J24185104		1-	A	D6
R 5035	CHIP RES.	0	1/16W	5%	RMC1/16 000JATP	J24185000		1-	A	C4
R 5036	CHIP RES.	470	1/16W	5%	RMC1/16 471JATP	J24185471		1-	A	C4
R 5038	CHIP RES.	47	1/2W	5%	RK73B2HTE47-OHMJ	J24279013		1-	A	E6
R 5039	CHIP RES.	100	1/16W	5%	RMC1/16 101JATP	J24185101		1-	A	E6
R 5040	CHIP RES.	470	1W	5%	RMC1 471JTE	J24305471		1-	A	E6
R 5041	CHIP RES.	1k	1/4W	5%	RMC1/4 102JATP	J24245102		1-	A	E6
R 5042	CHIP RES.	100	1/16W	5%	RMC1/16 101JATP	J24185101		1-	A	D6
R 5043	CHIP RES.	100	1/16W	5%	RMC1/16 101JATP	J24185101		1-	A	D6
R 5044	CHIP RES.	47	1/2W	5%	RK73B2HTE47-OHMJ	J24279013		1-	A	E6
R 5045	CHIP RES.	100	1/16W	5%	RMC1/16 101JATP	J24185101		1-	A	E6
R 5046	CHIP RES.	1k	1/4W	5%	RMC1/4 102JATP	J24245102		1-	A	E6
R 5047	CHIP RES.	470	1W	5%	RMC1 471JTE	J24305471		1-	A	E6
R 5048	CHIP RES.	10k	1/16W	5%	RMC1/16 103JATP	J24185103		1-	A	D6
R 5049	CHIP RES.	10k	1/16W	5%	RMC1/16 103JATP	J24185103		1-	A	D6
R 5050	CHIP RES.	0	1/16W	5%	RMC1/16 000JATP	J24185000		1-	A	C5
R 5051	CHIP RES.	220	1/16W	5%	RMC1/16 221JATP	J24185221		1-	A	C5
R 5052	CHIP RES.	0	1/16W	5%	RMC1/16 000JATP	J24185000		1-	A	D5
R 5054	CHIP RES.	100k	1/16W	5%	RMC1/16 104JATP	J24185104		1-	A	D5
R 5056	CHIP RES.	100k	1/16W	5%	RMC1/16 104JATP	J24185104		1-	A	C5
R 5057	CHIP RES.	100k	1/16W	5%	RMC1/16 104JATP	J24185104		1-	A	D5
R 5058	CHIP RES.	10k	1/16W	5%	RMC1/16 103JATP	J24185103		1-	A	D5
R 5059	CHIP RES.	10k	1/16W	5%	RMC1/16 103JATP	J24185103		1-	A	D5
R 5060	CHIP RES.	100k	1/16W	5%	RMC1/16 104JATP	J24185104		1-	A	D5
R 5061	CHIP RES.	10k	1/16W	5%	RMC1/16 103JATP	J24185103		1-	A	D5
R 5062	CHIP RES.	0	1/16W	5%	RMC1/16 000JATP	J24185000		1-	A	C5
R 5063	CHIP RES.	100k	1/16W	5%	RMC1/16 104JATP	J24185104		1-	A	C5
R 5064	CHIP RES.	100k	1/16W	5%	RMC1/16 104JATP	J24185104		1-	A	C5
R 5065	CHIP RES.	100k	1/16W	5%	RMC1/16 104JATP	J24185104		1-	A	D5
R 5066	CHIP RES.	100k	1/16W	5%	RMC1/16 104JATP	J24185104		1-	A	D5
R 5067	CHIP RES.	10k	1/16W	5%	RMC1/16 103JATP	J24185103		1-	A	D5
R 5068	METAL FILM RES.	3.3	2W	5%	ERX-2SJ3R3P 3.3	J22339003		1-	A	D4
R 5069	CHIP RES.	1k	1/10W	5%	RMC1/10T 102J	J24205102		1-	A	D4
R 5070	METAL FILM RES.	18	2W	5%	ERG-2SJ180P 18	J22339004		1-	A	D4
R 5071	CHIP RES.	100	1/10W	5%	RMC1/10T 101J	J24205101		1-	A	D5
R 5072	METAL FILM RES.	3.3	2W	5%	ERX-2SJ3R3P 3.3	J22339003		1-	A	E4
R 5073	CHIP RES.	100	1/10W	5%	RMC1/10T 101J	J24205101		1-	A	E5
R 5074	METAL FILM RES.	22	1W	5%	ERG-1SJ220 22	J22305220		1-	A	E5
R 5075	METAL FILM RES.	22	1W	5%	ERG-1SJ220 22	J22305220		1-	A	D5
R 5076	CHIP RES.	1k	1/10W	5%	RMC1/10T 102J	J24205102		1-	A	E4
R 5077	METAL FILM RES.	18	2W	5%	ERG-2SJ180P 18	J22339004		1-	A	F4
R 5078	CHIP RES.	100	1/10W	5%	RMC1/10T 101J	J24205101		1-	A	D5
R 5079	CHIP RES.	100	1/10W	5%	RMC1/10T 101J	J24205101		1-	A	D5
R 5080	SHUNT RES.	0.006		5%	R006J	J32009019		1-	A	E1
R 5081	CHIP RES.	10k	1/16W	5%	RMC1/16 103JATP	J24185103		1	A	E7
R 5081	CHIP RES.	10k	1/16W	1%	RMC1/16 103FTP	J24183103		2-	A	E7
R 5082	CHIP RES.	2.7k	1/16W	5%	RMC1/16 272JATP	J24185272		1	A	E7
R 5082	CHIP RES.	2.7k	1/16W	1%	RMC1/16 272FTP	J24183272		2-	A	E7
R 5083	CHIP RES.	10k	1/16W	5%	RMC1/16 103JATP	J24185103		1-	A	E7
R 5084	CHIP RES.	10k	1/16W	5%	RMC1/16 103JATP	J24185103		1-	A	E7
R 5085	CHIP RES.	10k	1/16W	5%	RMC1/16 103JATP	J24185103		1	A	E7
R 5085	CHIP RES.	10k	1/16W	1%	RMC1/16 103FTP	J24183103		2-	A	E7
R 5086	CHIP RES.	1M	1/16W	5%	RMC1/16 105JATP	J24185105		1-	A	E7
R 5087	CHIP RES.	10k	1/16W	5%	RMC1/16 103JATP	J24185103		1	A	E7
R 5087	CHIP RES.	10k	1/16W	1%	RMC1/16 103FTP	J24183103		2-	A	E7

PA-A Unit

Parts List

REF	DESCRIPTION	VALUE	V/W	TOL.	MFR'S DESIG	VXSTD P/N	VERS.	LOT	SIDE	LAY ADR
R 5088	CHIP RES.	3.9k	1/16W	5%	RMC1/16 392JATP	J24185392		1	A	E7
R 5088	CHIP RES.	3.9k	1/16W	1%	RMC1/16 392FTP	J24183392		2-	A	E7
R 5089	CHIP RES.	3.3k	1/16W	5%	RMC1/16 332JATP	J24185332		1	A	E7
R 5089	CHIP RES.	3.3k	1/16W	1%	RMC1/16 332FTP	J24183332		2-	A	E7
R 5090	CHIP RES.	10k	1/16W	5%	RMC1/16 103JATP	J24185103		1-	A	E7
R 5091	CHIP RES.	10k	1/16W	5%	RMC1/16 103JATP	J24185103		1-	A	E7
R 5092	CHIP RES.	10k	1/16W	5%	RMC1/16 103JATP	J24185103		1-	A	E7
R 5093	CHIP RES.	10k	1/16W	5%	RMC1/16 103JATP	J24185103		1-	A	E7
R 5094	CHIP RES.	470k	1/16W	5%	RMC1/16 474JATP	J24185474		1-	A	E7
R 5095	CHIP RES.	470k	1/16W	5%	RMC1/16 474JATP	J24185474		1-	A	E7
R 5096	CHIP RES.	4.7k	1/16W	5%	RMC1/16 472JATP	J24185472		1	A	F7
R 5096	CHIP RES.	4.7k	1/16W	1%	RMC1/16 472FTP	J24183472		2-	A	F7
R 5097	CHIP RES.	10k	1/16W	5%	RMC1/16 103JATP	J24185103		1	A	F7
R 5097	CHIP RES.	10k	1/16W	1%	RMC1/16 103FTP	J24183103		2-	A	F7
R 5098	CHIP RES.	10k	1/16W	5%	RMC1/16 103JATP	J24185103		1-	A	F7
R 5099	CHIP RES.	10k	1/16W	5%	RMC1/16 103JATP	J24185103		1-	A	F7
R 5100	CHIP RES.	470k	1/16W	5%	RMC1/16 474JATP	J24185474		1-	A	F7
R 5101	CHIP RES.	6.8k	1/10W	0.1%	RR1220P-682-B	J24209094		1-	A	F3
R 5102	CHIP RES.	6.8k	1/10W	0.1%	RR1220P-682-B	J24209094		1-	A	F3
R 5103	CHIP RES.	5.6k	1/10W	0.1%	RR1220R-562-B	J24209092		1-	A	F3
R 5104	CHIP RES.	5.6k	1/10W	0.1%	RR1220P-562-B	J24209092		1-	A	E3
R 5105	CHIP RES.	5.6k	1/16W	0.1%	RN731JTTD5601B25	J24189409		1-	A	F3
R 5106	CHIP RES.	5.6k	1/16W	0.1%	RN731JTTD5601B25	J24189409		1-	A	F3
R 5107	CHIP RES.	390k	1/10W	0.5%	RR1220R-394-D-T5	J24209233		1-	A	E3
R 5108	CHIP RES.	390k	1/10W	0.5%	RR1220R-394-D-T5	J24209233		1-	A	F3
R 5109	CHIP RES.	22	1W	5%	RMC1 220JTE	J24305220		1-	A	E7
R 5110	CHIP RES.	15	1W	5%	RMC1 150JTE	J24305150		1-	A	E7
R 5111	CHIP RES.	15	1W	5%	RMC1 150JTE	J24305150		1-	A	F7
R 5112	CHIP RES.	2.7k	1/16W	5%	RMC1/16 272JATP	J24185272		1-	A	D4
R 5113	CHIP RES.	10k	1/16W	5%	RMC1/16 103JATP	J24185103		1-	A	C7
R 5114	CHIP RES.	10k	1/16W	5%	RMC1/16 103JATP	J24185103		1-	A	D7
R 5115	CHIP RES.	10k	1/16W	5%	RMC1/16 103JATP	J24185103		1-	A	D7
R 5116	CHIP RES.	10k	1/16W	5%	RMC1/16 103JATP	J24185103		1-	A	D7
R 5117	CHIP RES.	10k	1/16W	5%	RMC1/16 103JATP	J24185103		1-	A	D7
R 5118	CHIP RES.	10k	1/16W	5%	RMC1/16 103JATP	J24185103		1-	A	D7
R 5119	CHIP RES.	10k	1/16W	5%	RMC1/16 103JATP	J24185103		1-	A	D7
R 5120	CHIP RES.	18k	1/16W	5%	RMC1/16 183JATP	J24185183		1-	A	D7
R 5121	CHIP RES.	3.9k	1/16W	5%	RMC1/16 392JATP	J24185392		1-	A	D7
R 5402	CHIP RES.	0	1/16W	5%	RMC1/16 000JATP	J24185000		5-	A	E1
R 5403	CHIP RES.	0	1/16W	5%	RMC1/16 000JATP	J24185000		1-	A	E1
R 5404	CARBON FILM RES.	330	1/2W	5%	RD12TJ331 330	J01275331		22-		
RL5001	RELAY		DC12V		G5V-1 DC12V	M1190120		1-	A	C2
RL5002	RELAY		DC12V		G5V-1 DC12V	M1190120		1-	A	C6
RL5003	RELAY		DC12V		G5V-1 DC12V	M1190120		1-	A	C3
RL5004	RELAY		DC12V		G5V-1 DC12V	M1190120		1-	A	C5
RL5005	RELAY		DC12V		G5V-1 DC12V	M1190120		1-	A	C7
RL5006	RELAY		DC12V		G5V-1 DC12V	M1190120		1-	A	C4
RL5007	RELAY		DC12V		AG201344 DC12V	M1190124		1-	A	C2
RL5008	RELAY		DC12V		G5V-1 DC12V	M1190120		1-	A	A3
RL5009	RELAY		DC12V		G5V-1 DC12V	M1190120		1-	A	A6
RL5010	RELAY		DC12V		G5V-1 DC12V	M1190120		1-	A	A4
RL5011	RELAY		DC12V		G5V-1 DC12V	M1190120		1-	A	A5
RL5012	RELAY		DC12V		G5V-1 DC12V	M1190120		1-	A	A7
RL5013	RELAY		DC12V		G5V-1 DC12V	M1190120		1-	A	A5
RL5014	RELAY		DC12V		AG201344 DC12V	M1190124		1-	A	A2
RL5401	RELAY		DC12V		ACP331 DC12V	M1190175		1-	A	D1
T 5001	COIL 10WIDE				#223153	L0022857		1-	A	E6
T 5002	COIL PWR-WIDE				D12A RIB10	L0022980A		1-	A	E5
T 5005	COIL PWR-WIDE				D12A RIB16	L0022399A		1-	A	E2
T 5401	TOROIDAL COIL				D12A R116X8X8(H007)	L0022745		1-	A	C1
TP5031	TERMINAL				TP-H MK-10160	Q5000037		1-	A	D1
TP5032	TERMINAL				TP-H MK-10160	Q5000037		1-	A	E1
	SHIELD CASE					R0131670A		1-		
	SHIELD CASE COVER					R0131680		1-		
	LEAF SPRING					R0120250		1-		

TUNER-UNIT
BR016920B (6001-6999)

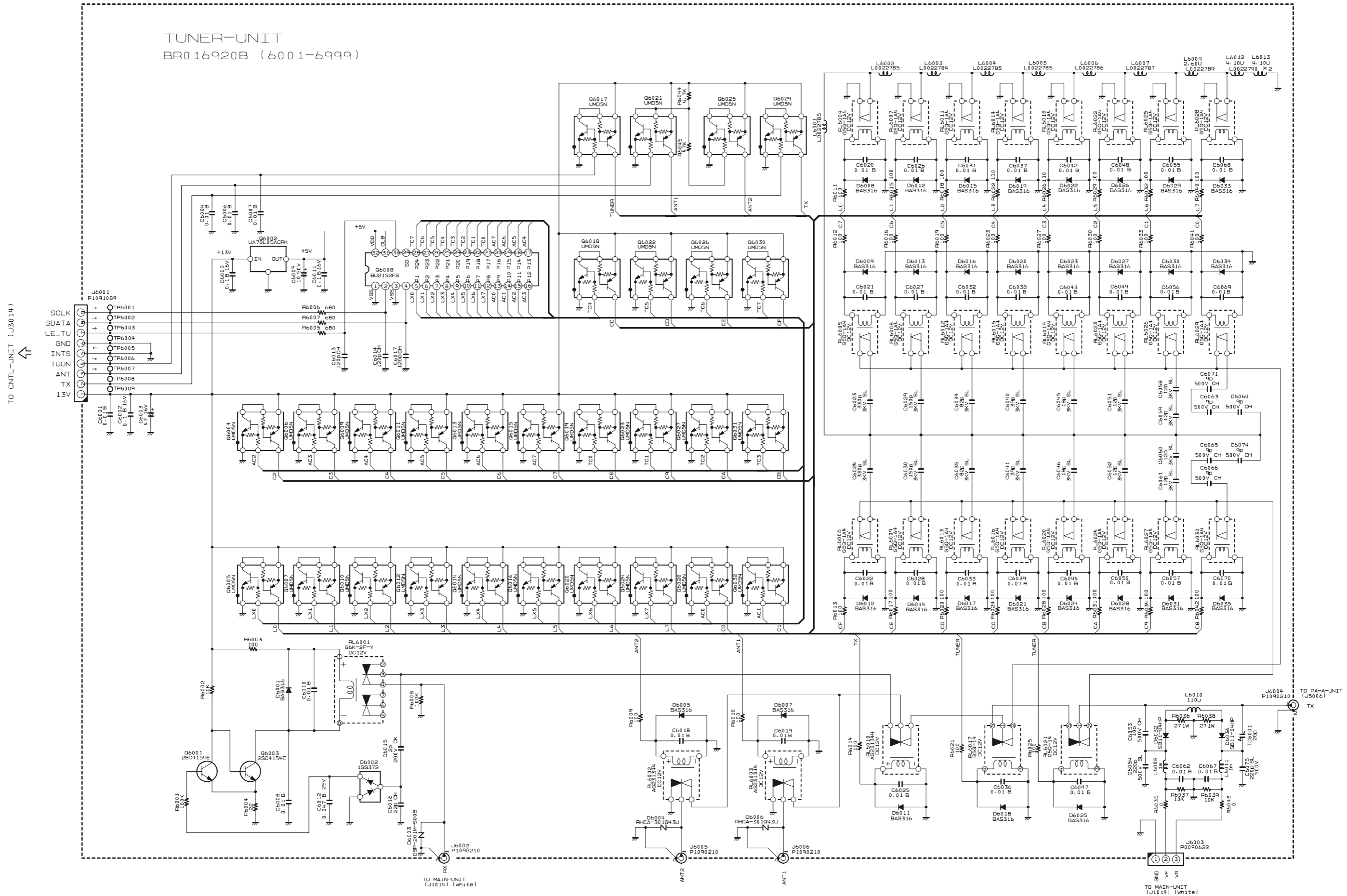

TUNER Unit

Note

Parts Layout (Side A)

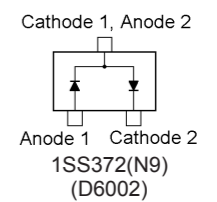
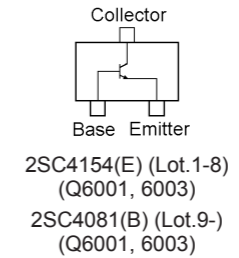
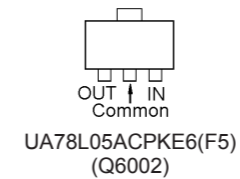
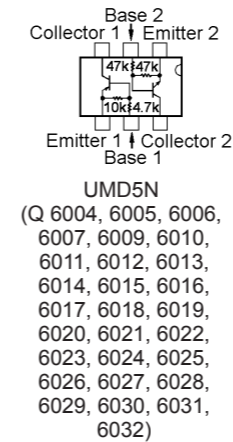
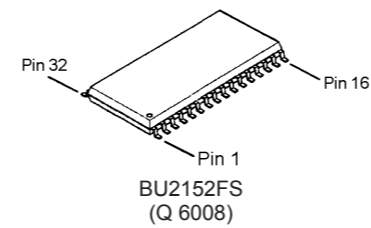
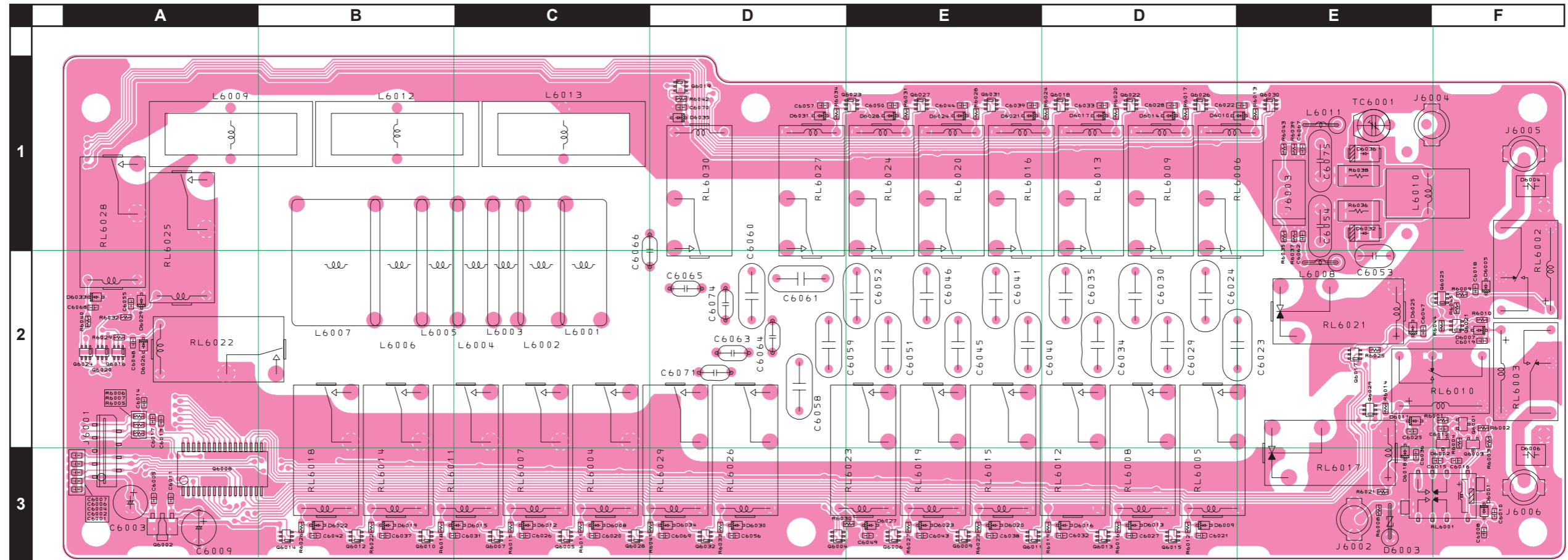

TUNER Unit

Parts Layout (Side B)

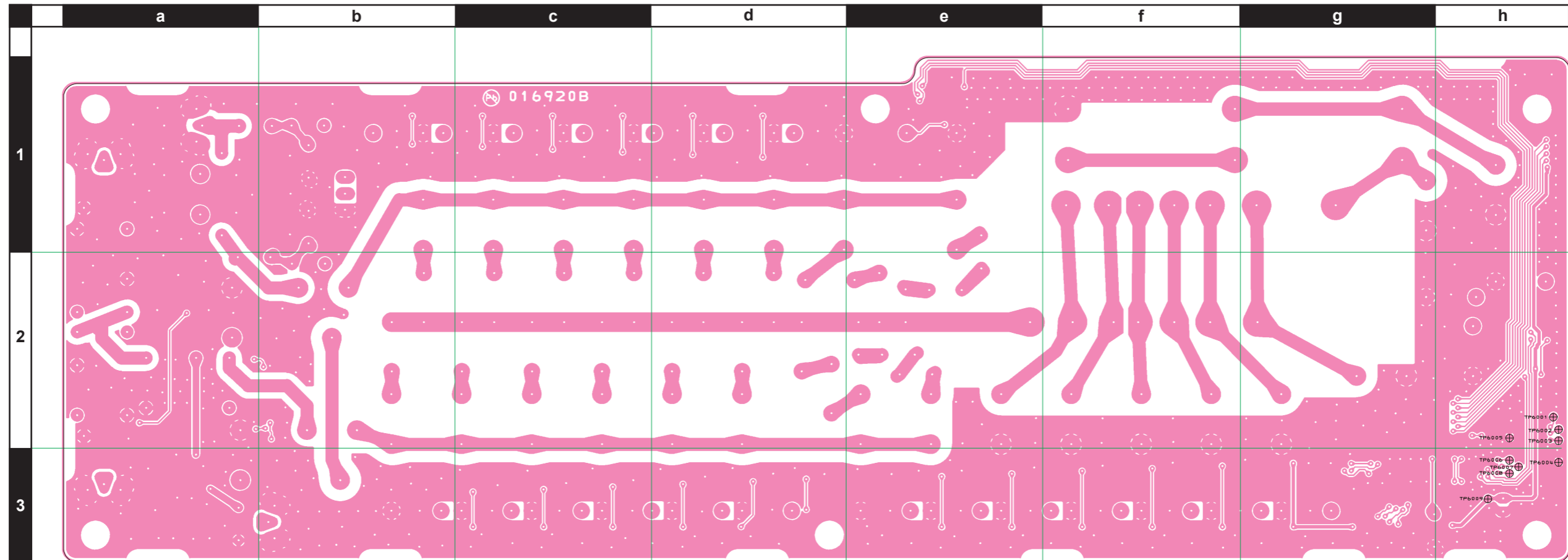

TUNER Unit

Parts List

REF	DESCRIPTION	VALUE	V/W	TOL.	MFR'S DESIG	VXSTD P/N	VERS.	LOT	SIDE	LAY ADR
PCB with Components						CS1969001				
	Printed Circuit Board					FR016920B			1-	
C 6001	CHIP CAP.	0.01uF	50V	B	GRM188B11H103KA01D	K22174823			1-	A A3
C 6002	CHIP CAP.	0.1uF	16V	B	GRM188B11C104KA01D	K22124805			1-	A A3
C 6003	AL.ELECTRO.CAP.	47uF	16V		RE2-16V470ME3#	K40129054			1-	A A3
C 6004	CHIP CAP.	0.01uF	50V	B	GRM188B11H103KA01D	K22174823			1-	A A3
C 6005	CHIP CAP.	0.1uF	16V	B	GRM188B11C104KA01D	K22124805			1-	A A3
C 6006	CHIP CAP.	0.01uF	50V	B	GRM188B11H103KA01D	K22174823			1-	A A3
C 6007	CHIP CAP.	0.01uF	50V	B	GRM188B11H103KA01D	K22174823			1-	A A3
C 6008	CHIP CAP.	0.01uF	50V	B	GRM188B11H103KA01D	K22174823			1-	A H3
C 6009	AL.ELECTRO.CAP.	10uF	50V		RE2-50V100ME3#-T2	K46170021			1-	A A3
C 6010	CHIP CAP.	0.01uF	50V	B	GRM188B11H103KA01D	K22174823			1-	A H3
C 6011	CHIP CAP.	0.1uF	16V	B	GRM188B11C104KA01D	K22124805			1-	A A3
C 6012	CHIP CAP.	0.047uF	25V	B	GRM188B11E473KA01D	K22144811			1-	A H2
C 6013	CHIP CAP.	120pF	50V	CH	GRM1882C1H121JA01D	K22174237			1-	A A2
C 6014	CHIP CAP.	120pF	50V	CH	GRM1882C1H121JA01D	K22174237			1-	A A2
C 6015	CHIP CAP.	2pF	200V	CK	GRM1884C2D2R0CV01D	K22234204			1-	A H3
C 6016	CHIP CAP.	22pF	50V	CH	GRM1882C1H220JA01D	K22174219			1-	A H3
C 6017	CHIP CAP.	120pF	50V	CH	GRM1882C1H121JA01D	K22174237			1-	A A2
C 6018	CHIP CAP.	0.01uF	50V	B	GRM188B11H103KA01D	K22174823			1-	A H2
C 6019	CHIP CAP.	0.01uF	50V	B	GRM188B11H103KA01D	K22174823			1-	A H2
C 6020	CHIP CAP.	0.01uF	50V	B	GRM188B11H103KA01D	K22174823			1-	A C3
C 6021	CHIP CAP.	0.01uF	50V	B	GRM188B11H103KA01D	K22174823			1-	A F3
C 6022	CHIP CAP.	0.01uF	50V	B	GRM188B11H103KA01D	K22174823			1-	A G1
C 6023	CERAMIC CAP.	330pF	3KV	SL	CC45SL3FD331JYNN	K00359031			1-	A F2
C 6024	CERAMIC CAP.	330pF	3KV	SL	CC45SL3FD331JYNN	K00359031			1-	A F2
C 6025	CHIP CAP.	0.01uF	50V	B	GRM188B11H103KA01D	K22174823			1-	A G2
C 6026	CHIP CAP.	0.01uF	50V	B	GRM188B11H103KA01D	K22174823			1-	A C3
C 6027	CHIP CAP.	0.01uF	50V	B	GRM188B11H103KA01D	K22174823			1-	A F3
C 6028	CHIP CAP.	0.01uF	50V	B	GRM188B11H103KA01D	K22174823			1-	A F1
C 6029	CERAMIC CAP.	150pF	3KV	SL	CC45SL3FD151KYAN	K00359030			1-	A F2
C 6029	CERAMIC CAP.	150pF	3KV	SL	CC45SL3FD151JYNN	K00359035			3-	A F2
C 6030	CERAMIC CAP.	150pF	3KV	SL	CC45SL3FD151KYAN	K00359030			1-	A F2
C 6030	CERAMIC CAP.	150pF	3KV	SL	CC45SL3FD151JYNN	K00359035			3-	A F2
C 6031	CHIP CAP.	0.01uF	50V	B	GRM188B11H103KA01D	K22174823			1-	A B3
C 6032	CHIP CAP.	0.01uF	50V	B	GRM188B11H103KA01D	K22174823			1-	A F3
C 6033	CHIP CAP.	0.01uF	50V	B	GRM188B11H103KA01D	K22174823			1-	A F1
C 6034	CERAMIC CAP.	82pF	3KV	SL	CC45SL3FD820KYAN	K00359029			1-	A F2
C 6034	CERAMIC CAP.	82pF	3KV	SL	CC45SL3FD820JYNN	K00359034			3-	A F2
C 6035	CERAMIC CAP.	82pF	3KV	SL	CC45SL3FD820KYAN	K00359029			1-	A F2
C 6035	CERAMIC CAP.	82pF	3KV	SL	CC45SL3FD820JYNN	K00359034			3-	A F2
C 6036	CHIP CAP.	0.01uF	50V	B	GRM188B11H103KA01D	K22174823			1-	A G3
C 6037	CHIP CAP.	0.01uF	50V	B	GRM188B11H103KA01D	K22174823			1-	A B3
C 6038	CHIP CAP.	0.01uF	50V	B	GRM188B11H103KA01D	K22174823			1-	A E3
C 6039	CHIP CAP.	0.01uF	50V	B	GRM188B11H103KA01D	K22174823			1-	A E1
C 6040	CERAMIC CAP.	39pF	3KV	SL	CC45SL3FD390JYVN	K26350001			1-	A E2
C 6040	CERAMIC CAP.	39pF	3KV	SL	CC45SL3FD390JYNN	K00359033			3-	A E2
C 6041	CERAMIC CAP.	39pF	3KV	SL	CC45SL3FD390JYVN	K26350001			1-	A E2
C 6041	CERAMIC CAP.	39pF	3KV	SL	CC45SL3FD390JYNN	K00359033			3-	A E2
C 6042	CHIP CAP.	0.01uF	50V	B	GRM188B11H103KA01D	K22174823			1-	A B3
C 6043	CHIP CAP.	0.01uF	50V	B	GRM188B11H103KA01D	K22174823			1-	A E3
C 6044	CHIP CAP.	0.01uF	50V	B	GRM188B11H103KA01D	K22174823			1-	A E1
C 6045	CERAMIC CAP.	18pF	3KV	SL	CC45SL3FD180JYNN	K00359028			1-	A E2
C 6046	CERAMIC CAP.	18pF	3KV	SL	CC45SL3FD180JYNN	K00359028			1-	A E2
C 6047	CHIP CAP.	0.01uF	50V	B	GRM188B11H103KA01D	K22174823			1-	A A2
C 6048	CHIP CAP.	0.01uF	50V	B	GRM188B11H103KA01D	K22174823			1-	A A2
C 6049	CHIP CAP.	0.01uF	50V	B	GRM188B11H103KA01D	K22174823			1-	A E3
C 6050	CHIP CAP.	0.01uF	50V	B	GRM188B11H103KA01D	K22174823			1-	A E1
C 6051	CERAMIC CAP.	12pF	3KV	SL	CC45SL3FD120JYAN	K00359027			1-	A E2
C 6051	CERAMIC CAP.	12pF	3KV	SL	CC45SL3FD120JYNN	K00359032			3-	A E2
C 6052	CERAMIC CAP.	12pF	3KV	SL	CC45SL3FD120JYAN	K00359027			1-	A E2
C 6052	CERAMIC CAP.	12pF	3KV	SL	CC45SL3FD120JYNN	K00359032			3-	A E2
C 6053	CERAMIC CAP.	10pF	500V	CH	RT-HM60SKCH100D	K26270151			1-	A G2
C 6054	CERAMIC CAP.	220pF	500V	SL	RT-HM95SKSL221J	K26270061			1-	A G1
C 6055	CHIP CAP.	0.01uF	50V	B	GRM188B11H103KA01D	K22174823			1-	A A2
C 6056	CHIP CAP.	0.01uF	50V	B	GRM188B11H103KA01D	K22174823			1-	A D3
C 6057	CHIP CAP.	0.01uF	50V	B	GRM188B11H103KA01D	K22174823			1-	A D1
C 6058	CERAMIC CAP.	12pF	3KV	SL	CC45SL3FD120JYAN	K00359027			1-	A D2
C 6058	CERAMIC CAP.	12pF	3KV	SL	CC45SL3FD120JYNN	K00359032			3-	A D2
C 6059	CERAMIC CAP.	12pF	3KV	SL	CC45SL3FD120JYAN	K00359027			1-	A D2
C 6059	CERAMIC CAP.	12pF	3KV	SL	CC45SL3FD120JYNN	K00359032			3-	A D2
C 6060	CERAMIC CAP.	12pF	3KV	SL	CC45SL3FD120JYAN	K00359027			1-	A D2
C 6060	CERAMIC CAP.	12pF	3KV	SL	CC45SL3FD120JYNN	K00359032			3-	A D2

TUNER Unit

Parts List

REF	DESCRIPTION	VALUE	V/W	TOL.	MFR'S DESIG	VXSTD P/N	VERS.	LOT	SIDE	LAY ADR
C 6061	CERAMIC CAP.	12pF	3KV	SL	CC45SL3FD120JYAN	K00359027		1-	A	D2
C 6061	CERAMIC CAP.	12pF	3KV	SL	CC45SL3FD120JYNN	K00359032		3-	A	D2
C 6062	CHIP CAP.	0.01uF	50V	B	GRM188B11H103KA01D	K22174823		1-	A	G1
C 6063	CERAMIC CAP.	9pF	500V	CH	RT-HM60SKCH090D	K26270150		1-	A	D2
C 6064	CERAMIC CAP.	9pF	500V	CH	RT-HM60SKCH090D	K26270150		1-	A	D2
C 6065	CERAMIC CAP.	9pF	500V	CH	RT-HM60SKCH090D	K26270150		1-	A	D2
C 6066	CERAMIC CAP.	9pF	500V	CH	RT-HM60SKCH090D	K26270150		1-	A	C2
C 6067	CHIP CAP.	0.01uF	50V	B	GRM188B11H103KA01D	K22174823		1-	A	G1
C 6068	CHIP CAP.	0.01uF	50V	B	GRM188B11H103KA01D	K22174823		1-	A	A2
C 6069	CHIP CAP.	0.01uF	50V	B	GRM188B11H103KA01D	K22174823		1-	A	D3
C 6070	CHIP CAP.	0.01uF	50V	B	GRM188B11H103KA01D	K22174823		1-	A	D1
C 6071	CERAMIC CAP.	9pF	500V	CH	RT-HM60SKCH090D	K26270150		1-	A	D2
C 6074	CERAMIC CAP.	9pF	500V	CH	RT-HM60SKCH090D	K26270150		1-	A	D2
C 6075	CERAMIC CAP.	220pF	500V	SL	RT-HM95SKSL221J	K26270061		1-	A	G1
D 6001	DIODE				BAS316	G2070716		1-	A	H3
D 6002	DIODE				1SS372(TE85R.F)	G2070632		1-	A	H2
D 6003	SURGE ABSORBER				DSP201M-S00B	Q9000375		1-	A	G3
D 6004	SURGE ABSORBER				RHCA-301Q43U	Q9000827		1-	A	H1
D 6005	DIODE				BAS316	G2070716		1-	A	H2
D 6006	SURGE ABSORBER				RHCA-301Q43U	Q9000827		1-	A	H3
D 6007	DIODE				BAS316	G2070716		1-	A	H2
D 6008	DIODE				BAS316	G2070716		1-	A	C3
D 6009	DIODE				BAS316	G2070716		1-	A	F3
D 6010	DIODE				BAS316	G2070716		1-	A	G1
D 6011	DIODE				BAS316	G2070716		1-	A	G2
D 6012	DIODE				BAS316	G2070716		1-	A	C3
D 6013	DIODE				BAS316	G2070716		1-	A	F3
D 6014	DIODE				BAS316	G2070716		1-	A	F1
D 6015	DIODE				BAS316	G2070716		1-	A	C3
D 6016	DIODE				BAS316	G2070716		1-	A	F3
D 6017	DIODE				BAS316	G2070716		1-	A	F1
D 6018	DIODE				BAS316	G2070716		1-	A	G3
D 6019	DIODE				BAS316	G2070716		1-	A	B3
D 6020	DIODE				BAS316	G2070716		1-	A	E3
D 6021	DIODE				BAS316	G2070716		1-	A	E1
D 6022	DIODE				BAS316	G2070716		1-	A	B3
D 6023	DIODE				BAS316	G2070716		1-	A	E3
D 6024	DIODE				BAS316	G2070716		1-	A	E1
D 6025	DIODE				BAS316	G2070716		1-	A	G2
D 6026	DIODE				BAS316	G2070716		1-	A	A2
D 6027	DIODE				BAS316	G2070716		1-	A	E3
D 6028	DIODE				BAS316	G2070716		1-	A	E1
D 6029	DIODE				BAS316	G2070716		1-	A	A2
D 6030	DIODE				BAS316	G2070716		1-	A	D3
D 6031	DIODE				BAS316	G2070716		1-	A	D1
D 6032	DIODE				SB11-04HP-TR	G2070866		1-	A	G1
D 6033	DIODE				BAS316	G2070716		1-	A	A2
D 6034	DIODE				BAS316	G2070716		1-	A	D3
D 6035	DIODE				BAS316	G2070716		1-	A	D1
D 6036	DIODE				SB11-04HP-TR	G2070866		1-	A	G1
J 6001	CONNECTOR				09FMN-BMTTN-TFT(LF)(SN)	P1091089		1-	A	A3
J 6002	CONNECTOR				TMP-J01X-V6	P1090210		1-	A	G3
J 6003	CONNECTOR				SC25-03WS	P0090622		1-	A	G1
J 6004	CONNECTOR				TMP-J01X-V6	P1090210		1-	A	G1
J 6005	CONNECTOR				TMP-J01X-V6	P1090210		1-	A	H1
J 6006	CONNECTOR				TMP-J01X-V6	P1090210		1-	A	H3
L 6001	COIL A1				2.5T16D1.6PEW R	L0022785		1-	A	C2
L 6002	COIL A1				2.5T16D1.6PEW R	L0022785		1-	A	C2
L 6003	COIL A1				1.5T16D1.6PEW R	L0022784		1-	A	C2
L 6004	COIL A1				2.5T16D1.6PEW R	L0022785		1-	A	C2
L 6005	COIL A1				2.5T16D1.6PEW R	L0022785		1-	A	C2
L 6006	COIL A1				3.5T16D1.6PEW R	L0022786		1-	A	B2
L 6007	COIL A1				6.5T16D1.6PEW R	L0022787		1-	A	B2
L 6008	M.RFC	1mH			LAL03NA102K	L1190189		1-	A	G2
L 6009	TOROIDAL COIL	2.6uH			2.60U T80-6	L0022789		1-	A	A1
L 6010	TOROIDAL COIL	110uH			110U R19.3-4.8-5	L0021859		1-	A	G1
L 6011	M.RFC	1mH			LAL03NA102K	L1190189		1-	A	G1
L 6012	TOROIDAL COIL	4.1uH			4.10U T80-2	L0022790		1-	A	B1
L 6013	TOROIDAL COIL	4.1uH			4.10U T80-2	L0022790		1-	A	C1
Q 6001	TRANSISTOR				2SC4154-T111-1E	G3341548E		1-	A	H2
Q 6001	TRANSISTOR				2SC4081 T106	G3340818		9-	A	H2
Q 6002	IC				UA78L05ACPKE6(TAPE)	G1094229		1-	A	A3
Q 6003	TRANSISTOR				2SC4154-T111-1E	G3341548E		1-	A	H2

TUNER Unit

Parts List

REF	DESCRIPTION	VALUE	V/W	TOL.	MFR'S DESIG	VXSTD P/N	VERS.	LOT	SIDE	LAY ADR
Q 6003	TRANSISTOR				2SC4081 T106	G3340818		9-	A	H2
Q 6004	TRANSISTOR				UMD5N TR	G3070343		1-	A	D3
Q 6005	TRANSISTOR				UMD5N TR	G3070343		1-	A	C3
Q 6006	TRANSISTOR				UMD5N TR	G3070343		1-	A	E3
Q 6007	TRANSISTOR				UMD5N TR	G3070343		1-	A	C3
Q 6008	IC				BU2152FS(TAPE)	G1093942		1-	A	A3
Q 6009	TRANSISTOR				UMD5N TR	G3070343		1-	A	E3
Q 6010	TRANSISTOR				UMD5N TR	G3070343		1-	A	B3
Q 6011	TRANSISTOR				UMD5N TR	G3070343		1-	A	E3
Q 6012	TRANSISTOR				UMD5N TR	G3070343		1-	A	B3
Q 6013	TRANSISTOR				UMD5N TR	G3070343		1-	A	F3
Q 6014	TRANSISTOR				UMD5N TR	G3070343		1-	A	B3
Q 6015	TRANSISTOR				UMD5N TR	G3070343		1-	A	F3
Q 6016	TRANSISTOR				UMD5N TR	G3070343		1-	A	A2
Q 6017	TRANSISTOR				UMD5N TR	G3070343		1-	A	G2
Q 6018	TRANSISTOR				UMD5N TR	G3070343		1-	A	F1
Q 6019	TRANSISTOR				UMD5N TR	G3070343		1-	A	D1
Q 6020	TRANSISTOR				UMD5N TR	G3070343		1-	A	A2
Q 6021	TRANSISTOR				UMD5N TR	G3070343		1-	A	H2
Q 6022	TRANSISTOR				UMD5N TR	G3070343		1-	A	F1
Q 6023	TRANSISTOR				UMD5N TR	G3070343		1-	A	E1
Q 6024	TRANSISTOR				UMD5N TR	G3070343		1-	A	A2
Q 6025	TRANSISTOR				UMD5N TR	G3070343		1-	A	H2
Q 6026	TRANSISTOR				UMD5N TR	G3070343		1-	A	F1
Q 6027	TRANSISTOR				UMD5N TR	G3070343		1-	A	E1
Q 6028	TRANSISTOR				UMD5N TR	G3070343		1-	A	C3
Q 6029	TRANSISTOR				UMD5N TR	G3070343		1-	A	G2
Q 6030	TRANSISTOR				UMD5N TR	G3070343		1-	A	G1
Q 6031	TRANSISTOR				UMD5N TR	G3070343		1-	A	E1
Q 6032	TRANSISTOR				UMD5N TR	G3070343		1-	A	D3
R 6001	CHIP RES.	100k	1/16W	5%	RMC1/16 104JATP	J24185104		1-	A	H2
R 6002	CHIP RES.	10k	1/16W	5%	RMC1/16 103JATP	J24185103		1-	A	H2
R 6003	CHIP RES.	100	1/16W	5%	RMC1/16 101JATP	J24185101		1-	A	H2
R 6004	CHIP RES.	22	1/16W	5%	RMC1/16 220JATP	J24185220		1-	A	H2
R 6005	CHIP RES.	680	1/16W	5%	RMC1/16 681JATP	J24185681		1-	A	A2
R 6006	CHIP RES.	680	1/16W	5%	RMC1/16 681JATP	J24185681		1-	A	A2
R 6007	CHIP RES.	680	1/16W	5%	RMC1/16 681JATP	J24185681		1-	A	A2
R 6008	CHIP RES.	100k	1/16W	5%	RMC1/16 104JATP	J24185104		1-	A	G3
R 6009	CHIP RES.	100	1/16W	5%	RMC1/16 101JATP	J24185101		1-	A	H2
R 6010	CHIP RES.	100	1/16W	5%	RMC1/16 101JATP	J24185101		1-	A	H2
R 6011	CHIP RES.	100	1/16W	5%	RMC1/16 101JATP	J24185101		1-	A	C3
R 6012	CHIP RES.	100	1/16W	5%	RMC1/16 101JATP	J24185101		1-	A	F3
R 6013	CHIP RES.	100	1/16W	5%	RMC1/16 101JATP	J24185101		1-	A	G1
R 6014	CHIP RES.	100	1/16W	5%	RMC1/16 101JATP	J24185101		1-	A	G2
R 6015	CHIP RES.	100	1/16W	5%	RMC1/16 101JATP	J24185101		1-	A	C3
R 6016	CHIP RES.	100	1/16W	5%	RMC1/16 101JATP	J24185101		1-	A	F3
R 6017	CHIP RES.	100	1/16W	5%	RMC1/16 101JATP	J24185101		1-	A	F1
R 6018	CHIP RES.	100	1/16W	5%	RMC1/16 101JATP	J24185101		1-	A	B3
R 6019	CHIP RES.	100	1/16W	5%	RMC1/16 101JATP	J24185101		1-	A	F3
R 6020	CHIP RES.	100	1/16W	5%	RMC1/16 101JATP	J24185101		1-	A	F1
R 6021	CHIP RES.	100	1/16W	5%	RMC1/16 101JATP	J24185101		1-	A	G3
R 6022	CHIP RES.	100	1/16W	5%	RMC1/16 101JATP	J24185101		1-	A	B3
R 6023	CHIP RES.	100	1/16W	5%	RMC1/16 101JATP	J24185101		1-	A	E3
R 6024	CHIP RES.	100	1/16W	5%	RMC1/16 101JATP	J24185101		1-	A	F1
R 6025	CHIP RES.	100	1/16W	5%	RMC1/16 101JATP	J24185101		1-	A	G2
R 6026	CHIP RES.	100	1/16W	5%	RMC1/16 101JATP	J24185101		1-	A	B3
R 6027	CHIP RES.	100	1/16W	5%	RMC1/16 101JATP	J24185101		1-	A	E3
R 6028	CHIP RES.	100	1/16W	5%	RMC1/16 101JATP	J24185101		1-	A	E1
R 6029	CHIP RES.	100	1/16W	5%	RMC1/16 101JATP	J24185101		1-	A	A2
R 6030	CHIP RES.	100	1/16W	5%	RMC1/16 101JATP	J24185101		1-	A	E3
R 6031	CHIP RES.	100	1/16W	5%	RMC1/16 101JATP	J24185101		1-	A	E1
R 6032	CHIP RES.	100	1/16W	5%	RMC1/16 101JATP	J24185101		1-	A	A2
R 6033	CHIP RES.	100	1/16W	5%	RMC1/16 101JATP	J24185101		1-	A	D3
R 6034	CHIP RES.	100	1/16W	5%	RMC1/16 101JATP	J24185101		1-	A	D1
R 6035	CHIP RES.	0	1/16W	5%	RMC1/16 000JATP	J24185000		1-	A	G1
R 6036	CHIP RES.	27	1W	5%	RMC1 270JTE	J24305270		1-	A	G1
R 6037	CHIP RES.	10k	1/16W	5%	RMC1/16 103JATP	J24185103		1-	A	G1
R 6038	CHIP RES.	27	1W	5%	RMC1 270JTE	J24305270		1-	A	G1
R 6039	CHIP RES.	10k	1/16W	5%	RMC1/16 103JATP	J24185103		1-	A	G1
R 6040	CHIP RES.	100	1/16W	5%	RMC1/16 101JATP	J24185101		1-	A	A2
R 6041	CHIP RES.	100	1/16W	5%	RMC1/16 101JATP	J24185101		1-	A	C3
R 6042	CHIP RES.	100	1/16W	5%	RMC1/16 101JATP	J24185101		1-	A	D1
R 6043	CHIP RES.	0	1/16W	5%	RMC1/16 000JATP	J24185000		1-	A	G1

TUNER Unit

Parts List

REF	DESCRIPTION	VALUE	V/W	TOL.	MFR'S DESIG	VXSTD P/N	VERS.	LOT	SIDE	LAY ADR
R 6044	CHIP RES.	4.7k	1/16W	5%	RMC1/16 472JATP	J24185472		1-	A	H2
R 6045	CHIP RES.	47k	1/16W	5%	RMC1/16 473JATP	J24185473		1-	A	H2
RL6001	RELAY		DC12V		G6K-2F-Y-TR DC12V	M1190183		1-	A	H3
RL6002	RELAY		DC12V		AG231344 DC12V	M1190145		1-	A	H2
RL6003	RELAY		DC12V		AG231344 DC12V	M1190145		1-	A	H2
RL6004	RELAY		DC12V		G5Q-1A4 DC12V	M1190200		1-	A	C3
RL6005	RELAY		DC12V		G5Q-1A4 DC12V	M1190200		1-	A	F3
RL6006	RELAY		DC12V		G5Q-1A4 DC12V	M1190200		1-	A	G1
RL6007	RELAY		DC12V		G5Q-1A4 DC12V	M1190200		1-	A	C3
RL6008	RELAY		DC12V		G5Q-1A4 DC12V	M1190200		1-	A	F3
RL6009	RELAY		DC12V		G5Q-1A4 DC12V	M1190200		1-	A	F1
RL6010	RELAY		DC12V		AG231344 DC12V	M1190145		1-	A	G2
RL6011	RELAY		DC12V		G5Q-1A4 DC12V	M1190200		1-	A	B3
RL6012	RELAY		DC12V		G5Q-1A4 DC12V	M1190200		1-	A	F3
RL6013	RELAY		DC12V		G5Q-1A4 DC12V	M1190200		1-	A	F1
RL6014	RELAY		DC12V		G5Q-1A4 DC12V	M1190200		1-	A	B3
RL6015	RELAY		DC12V		G5Q-1A4 DC12V	M1190200		1-	A	E3
RL6016	RELAY		DC12V		G5Q-1A4 DC12V	M1190200		1-	A	F1
RL6017	RELAY		DC12V		G5Q-14 DC12V	M1190199		1-	A	G3
RL6018	RELAY		DC12V		G5Q-1A4 DC12V	M1190200		1-	A	B3
RL6019	RELAY		DC12V		G5Q-1A4 DC12V	M1190200		1-	A	E3
RL6020	RELAY		DC12V		G5Q-1A4 DC12V	M1190200		1-	A	E1
RL6021	RELAY		DC12V		G5Q-14 DC12V	M1190199		1-	A	G2
RL6022	RELAY		DC12V		G5Q-1A4 DC12V	M1190200		1-	A	A2
RL6023	RELAY		DC12V		G5Q-1A4 DC12V	M1190200		1-	A	D3
RL6024	RELAY		DC12V		G5Q-1A4 DC12V	M1190200		1-	A	E1
RL6025	RELAY		DC12V		G5Q-1A4 DC12V	M1190200		1-	A	A2
RL6026	RELAY		DC12V		G5Q-1A4 DC12V	M1190200		1-	A	D3
RL6027	RELAY		DC12V		G5Q-1A4 DC12V	M1190200		1-	A	D1
RL6028	RELAY		DC12V		G5Q-1A4 DC12V	M1190200		1-	A	A2
RL6029	RELAY		DC12V		G5Q-1A4 DC12V	M1190200		1-	A	C3
RL6030	RELAY		DC12V		G5Q-1A4 DC12V	M1190200		1-	A	D1
TC6001	TRIMMER CAP.	20pF			CV05D2001	K91000278		1-	A	G1

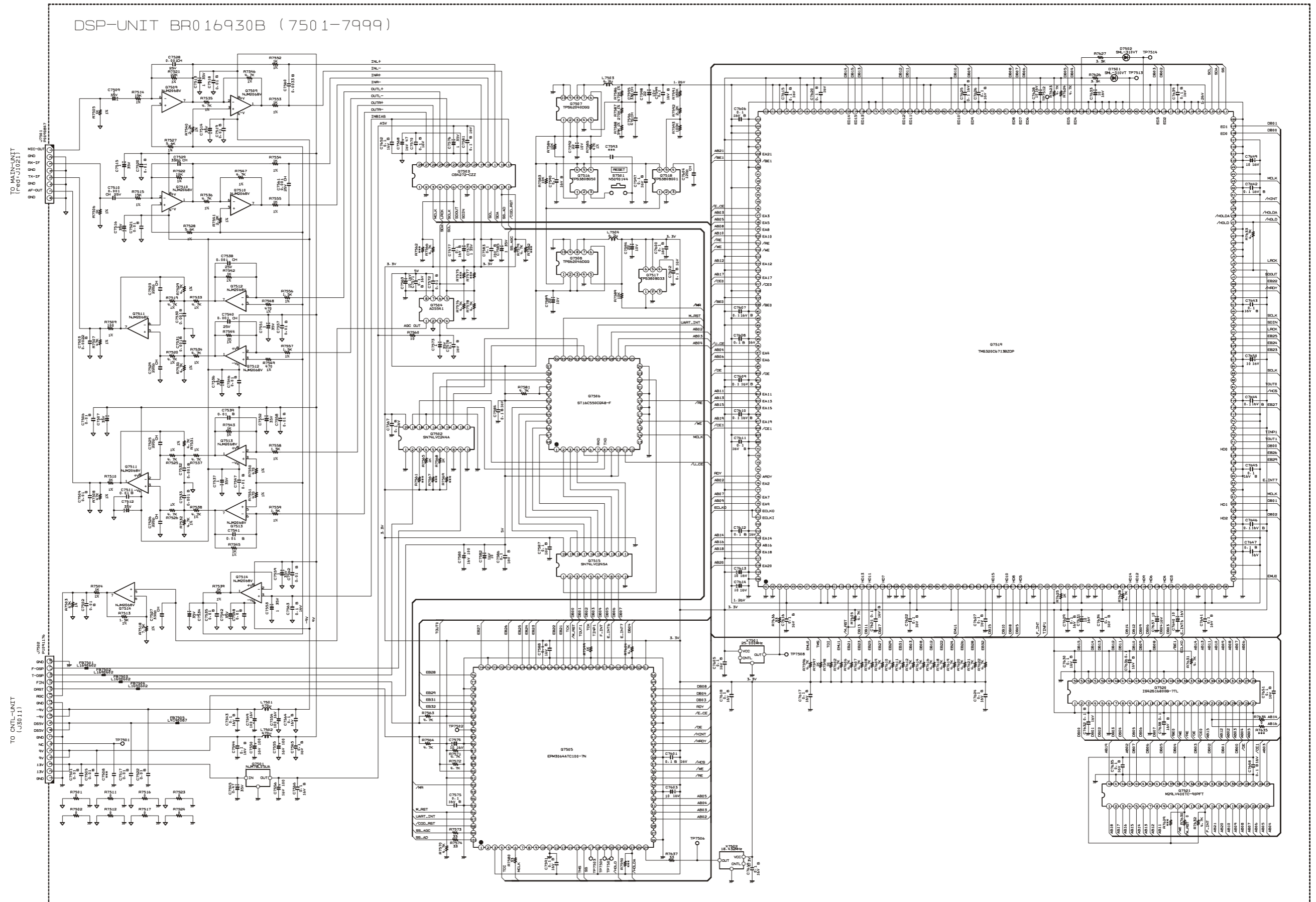

DSP Unit (Lot.1~42)

Note

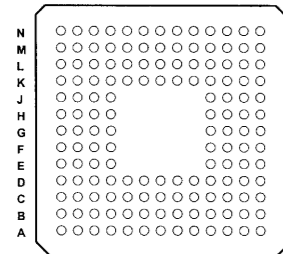
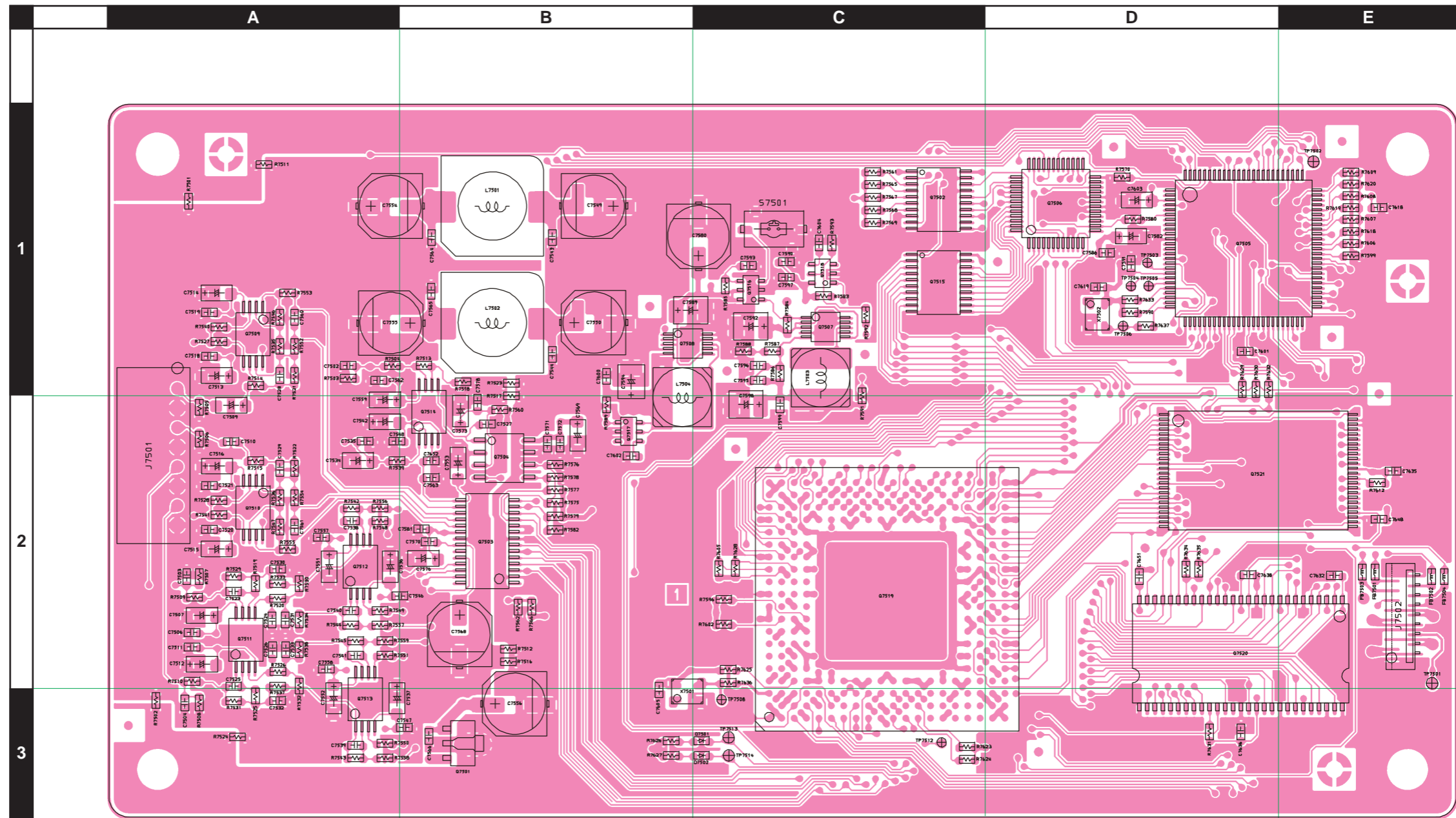

Bottom View
TMS320C6713BZDP
(Q7519)

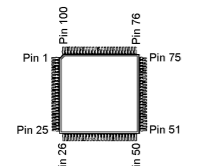

EPM3064ATC100
(Q7505)

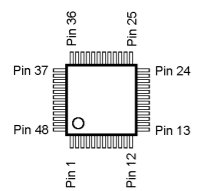

ST16C550CQ48-F
(Q7506)

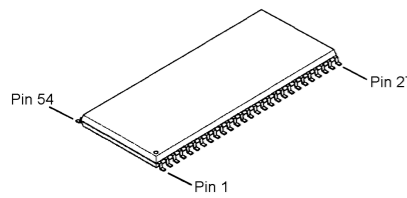

IS42S16800B
(Q7520)

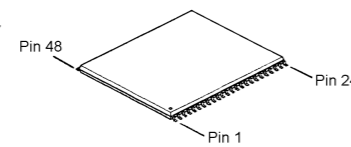

M29LV400TC
(Q7521)

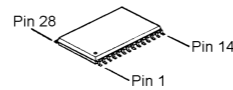

CS4272
(Q7503)

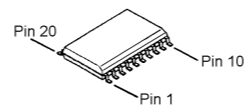

SN74LVC244PWR
(Q7502)

SN74LVC245PWR
(Q7515)

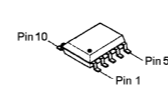

TPS62040DGQ
(Q7507)

TPS62046DGQ
(Q7508)

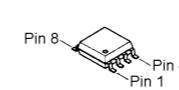

AD5541JR
(Q7504)

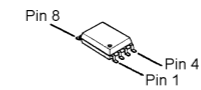

NJM2068V
(Q7509, 7510, 7511,
7512, 7513, 7514)

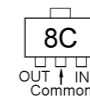

NJM75L05UA (8C)
(Q7501)

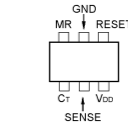

TPS3808G01
(Q7518)

TPS3808G33
(Q7517)

TPS3808G50
(Q7516)

DSP Unit (Lot.1~42)

Parts List

REF	DESCRIPTION	VALUE	V/W	TOL.	MFR'S DESIG	VXSTD P/N	VERS.	LOT	SIDE	LAY ADR
PCB with Components						CS1965001				
	Printed Circuit Board					FR016930B			1-	
C 7501	CHIP CAP.	0.01uF	50V	B	GRM188B11H103KA01D	K22174823		1-	B	a2
C 7502	CHIP CAP.	0.01uF	50V	B	GRM188B11H103JA01D	K22174824		1-	A	A1
C 7503	CHIP CAP.	0.0022uF	50V	B	GRM188B11H222KA01D	K22174822		1-	A	A2
C 7504	CHIP CAP.	0.01uF	50V	B	GRM188B11H103JA01D	K22174824		1-	A	A3
C 7505	CHIP CAP.	0.01uF	50V	B	GRM188B11H103KA01D	K22174823		1-	B	a2
C 7506	CHIP CAP.	0.01uF	50V	B	GRM188B11H103KA01D	K22174823		1-	A	A2
C 7507	CHIP TA.CAP.	1uF	35V		TEESVA1V105M8R	K78160032		1-	A	A2
C 7509	CHIP TA.CAP.	1uF	35V		TEESVA1V105M8R	K78160032		1-	A	A2
C 7510	CHIP CAP.	0.001uF	25V	CH	GRM1882C1E102JA01D	K22144204		1-	A	A2
C 7511	CHIP CAP.	0.01uF	50V	B	GRM188B11H103KA01D	K22174823		1-	A	A2
C 7512	CHIP TA.CAP.	1uF	35V		TEESVA1V105M8R	K78160032		1-	A	A2
C 7513	CHIP TA.CAP.	1uF	35V		TEESVA1V105M8R	K78160032		1-	A	A1
C 7514	CHIP TA.CAP.	1uF	35V		TEESVA1V105M8R	K78160032		1-	A	A1
C 7515	CHIP TA.CAP.	1uF	35V		TEESVA1V105M8R	K78160032		1-	A	A2
C 7516	CHIP TA.CAP.	1uF	35V		TEESVA1V105M8R	K78160032		1-	A	A2
C 7517	CHIP CAP.	0.01uF	50V	B	GRM188B11H103KA01D	K22174823		1-	B	a2
C 7518	CHIP CAP.	0.01uF	50V	B	GRM188B11H103KA01D	K22174823		1-	A	A1
C 7519	CHIP CAP.	0.01uF	50V	B	GRM188B11H103KA01D	K22174823		1-	A	A1
C 7520	CHIP CAP.	0.01uF	50V	B	GRM188B11H103KA01D	K22174823		1-	A	A2
C 7521	CHIP CAP.	0.01uF	50V	B	GRM188B11H103KA01D	K22174823		1-	A	A2
C 7522	CHIP CAP.	0.01uF	50V	B	GRM188B11H103KA01D	K22174823		1-	B	a2
C 7523	CHIP CAP.	220pF	50V	CH	GRM1882C1H221JA01D	K22174243		1-	A	A2
C 7524	CHIP CAP.	220pF	50V	CH	GRM1882C1H221JA01D	K22174243		1-	A	A2
C 7525	CHIP CAP.	220pF	50V	CH	GRM1882C1H221JA01D	K22174243		1-	A	A2
C 7526	CHIP CAP.	220pF	50V	CH	GRM1882C1H221JA01D	K22174243		1-	A	A2
C 7527	CHIP CAP.	330pF	50V	CH	GRM1882C1H331JA01D	K22174253		1-	A	B2
C 7528	CHIP CAP.	0.001uF	25V	CH	GRM1882C1E102JA01D	K22144204		1-	A	A1
C 7529	CHIP CAP.	330pF	50V	CH	GRM1882C1H331JA01D	K22174253		1-	A	A2
C 7530	CHIP CAP.	0.001uF	50V	B	GRM188B11H102KA01D	K22174821		1-	A	A2
C 7531	CHIP CAP.	0.001uF	50V	B	GRM188B11H102KA01D	K22174821		1-	A	A2
C 7532	CHIP CAP.	0.001uF	50V	B	GRM188B11H102KA01D	K22174821		1-	A	A3
C 7533	CHIP CAP.	0.001uF	50V	B	GRM188B11H102KA01D	K22174821		1-	A	A2
C 7534	CHIP TA.CAP.	1uF	35V		TEESVA1V105M8R	K78160032		1-	A	A2
C 7535	CHIP CAP.	0.01uF	50V	B	GRM188B11H103KA01D	K22174823		1-	A	A2
C 7536	CHIP TA.CAP.	1uF	35V		TEESVA1V105M8R	K78160032		1-	A	A2
C 7537	CHIP TA.CAP.	1uF	35V		TEESVA1V105M8R	K78160032		1-	A	A3
C 7538	CHIP CAP.	0.001uF	25V	CH	GRM1882C1E102JA01D	K22144204		1-	A	A2
C 7539	CHIP CAP.	0.01uF	50V	B	GRM188B11H103JA01D	K22174824		1-	A	A3
C 7540	CHIP CAP.	0.001uF	25V	CH	GRM1882C1E102JA01D	K22144204		1-	A	A2
C 7541	CHIP CAP.	0.01uF	50V	B	GRM188B11H103JA01D	K22174824		1-	A	A2
C 7542	CHIP TA.CAP.	1uF	35V		TEESVA1V105M8R	K78160032		1-	A	A2
C 7543	CHIP CAP.	0.1uF	16V	B	GRM188B11C104KA01D	K22124805		1-	A	B1
C 7544	CHIP CAP.	0.1uF	16V	B	GRM188B11C104KA01D	K22124805		1-	A	B1
C 7545	CHIP TA.CAP.	0.47uF	35V		TEESVA1V474M8R	K78160029		1-	B	d3
C 7546	CHIP CAP.	0.01uF	50V	B	GRM188B11H103KA01D	K22174823		1-	A	A2
C 7547	CHIP CAP.	0.01uF	50V	B	GRM188B11H103KA01D	K22174823		1-	A	B3
C 7548	CHIP CAP.	0.01uF	50V	B	GRM188B11H103KA01D	K22174823		1-	A	A2
C 7549	AL.ELECTRO.CAP.	100uF	16V		EEE1CA101WP	K48120012		1-	A	B1
C 7550	AL.ELECTRO.CAP.	100uF	16V		EEE1CA101WP	K48120012		1-	A	B1
C 7551	CHIP TA.CAP.	1uF	35V		TEESVA1V105M8R	K78160032		1-	A	A2
C 7552	CHIP TA.CAP.	1uF	35V		TEESVA1V105M8R	K78160032		1-	A	A3
C 7553	CHIP TA.CAP.	1uF	35V		TEESVA1V105M8R	K78160032		1-	A	B2
C 7554	AL.ELECTRO.CAP.	100uF	16V		EEE1CA101WP	K48120012		1-	A	A1
C 7555	AL.ELECTRO.CAP.	100uF	16V		EEE1CA101WP	K48120012		1-	A	A1
C 7556	AL.ELECTRO.CAP.	100uF	16V		EEE1CA101WP	K48120012		1-	A	B3
C 7557	CHIP CAP.	0.01uF	50V	B	GRM188B11H103KA01D	K22174823		1-	A	A2
C 7558	CHIP CAP.	0.01uF	50V	B	GRM188B11H103KA01D	K22174823		1-	A	A2
C 7559	CHIP TA.CAP.	1uF	35V		TEESVA1V105M8R	K78160032		1-	A	A2
C 7560	CHIP CAP.	0.0033uF	50V	B	GRM188B11H332KA01D	K22174815		1-	A	A1
C 7561	CHIP CAP.	0.001uF	25V	CH	GRM1882C1E102JA01D	K22144204		1-	A	A2
C 7562	CHIP CAP.	0.01uF	50V	B	GRM188B11H103KA01D	K22174823		1-	A	A1
C 7563	CHIP CAP.	0.1uF	16V	B	GRM188B11C104KA01D	K22124805		1-	A	B2
C 7564	CHIP CAP.	0.1uF	16V	B	GRM188B11C104KA01D	K22124805		1-	A	B1
C 7565	CHIP CAP.	0.1uF	16V	B	GRM188B11C104KA01D	K22124805		1-	A	B1
C 7566	CHIP CAP.	0.1uF	16V	B	GRM188B11C104KA01D	K22124805		1-	A	B3
C 7567	CHIP CAP.	0.1uF	16V	B	GRM188B11C104KA01D	K22124805		1-	B	b1
C 7568	AL.ELECTRO.CAP.	47uF	16V		EEE1CA470SP	K48120005		1-	A	B2
C 7569	CHIP TA.CAP.	10uF	16V		TEESVA1C106M8R	K78120077		1-	A	B2
C 7570	CHIP CAP.	0.1uF	16V	B	GRM188B11C104KA01D	K22124805		1-	A	B2
C 7571	CHIP CAP.	0.1uF	16V	B	GRM188B11C104KA01D	K22124805		1-	A	B2
C 7572	CHIP CAP.	0.01uF	50V	B	GRM188B11H103KA01D	K22174823		1-	A	B2

DSP Unit (Lot.1~42)

Parts List

REF	DESCRIPTION	VALUE	V/W	TOL.	MFR'S DESIG	VXSTD P/N	VERS.	LOT	SIDE	LAY ADR
C 7573	CHIP TA.CAP.	1uF	35V		TEESVA1V105M8R	K78160032		1-	A	B2
C 7574	CHIP TA.CAP.	10uF	16V		TEESVA1C106M8R	K78120077		1-	B	a1
C 7575	CHIP CAP.	0.1uF	16V	B	GRM188B11C104KA01D	K22124805		1-	B	a1
C 7576	CHIP TA.CAP.	1uF	35V		TEESVA1V105M8R	K78160032		1-	A	B2
C 7577	CHIP CAP.	0.1uF	16V	B	GRM188B11C104KA01D	K22124805		1-	B	d2
C 7578	CHIP CAP.	0.1uF	16V	B	GRM188B11C104KA01D	K22124805		1-	A	B2
C 7579	CHIP TA.CAP.	1uF	35V		TEESVA1V105M8R	K78160032		1-	B	d2
C 7580	AL.ELECTRO.CAP.	100uF	16V		EEE1CA101WP	K48120012		1-	A	C1
C 7581	CHIP CAP.	0.1uF	16V	B	GRM188B11C104KA01D	K22124805		1-	A	B2
C 7582	CHIP TA.CAP.	10uF	16V		TEESVA1C106M8R	K78120077		1-	A	D1
C 7583	CHIP CAP.	0.1uF	16V	B	GRM188B11C104KA01D	K22124805		1-	B	d2
C 7584	CHIP CAP.	0.1uF	16V	B	GRM188B11C104KA01D	K22124805		1-	B	b1
C 7585	CHIP TA.CAP.	1uF	35V		TEESVA1V105M8R	K78160032		1-	B	d2
C 7586	CHIP CAP.	0.1uF	16V	B	GRM188B11C104KA01D	K22124805		1-	A	D1
C 7587	CHIP CAP.	0.1uF	16V	B	GRM188B11C104KA01D	K22124805		1-	B	b1
C 7588	CHIP CAP.	0.1uF	16V	B	GRM188B11C104KA01D	K22124805		1-	B	a1
C 7589	CHIP TA.CAP.	22uF	10V		TEESVB21A226M8R	K78100029		1-	A	B1
C 7590	CHIP CAP.	0.1uF	16V	B	GRM188B11C104KA01D	K22124805		1-	A	C1
C 7591	CHIP CAP.	0.1uF	16V	B	GRM188B11C104KA01D	K22124805		1-	A	D1
C 7592	CHIP TA.CAP.	22uF	10V		TEESVB21A226M8R	K78100029		1-	A	C1
C 7594	CHIP TA.CAP.	22uF	10V		TEESVB21A226M8R	K78100029		1-	A	B1
C 7595	CHIP CAP.	33pF	50V	CH	GRM1882C1H330JA01D	K22174223		1-	A	C1
C 7596	CHIP CAP.	47pF	50V	CH	GRM1882C1H470JA01D	K22174227		1-	A	C1
C 7597	CHIP CAP.	0.1uF	16V	B	GRM188B11C104KA01D	K22124805		1-	A	C1
C 7598	CHIP TA.CAP.	22uF	10V		TEESVB21A226M8R	K78100029		1-	A	C2
C 7599	CHIP CAP.	0.1uF	16V	B	GRM188B11C104KA01D	K22124805		1-	A	C2
C 7600	CHIP CAP.	0.1uF	16V	B	GRM188B11C104KA01D	K22124805		1-	A	B1
C 7601	CHIP CAP.	0.1uF	16V	B	GRM188B11C104KA01D	K22124805		1-	A	D1
C 7602	CHIP CAP.	0.1uF	16V	B	GRM188B11C104KA01D	K22124805		1-	A	B2
C 7603	CHIP TA.CAP.	10uF	16V		TEESVA1C106M8R	K78120077		1-	A	D1
C 7604	CHIP CAP.	120pF	50V	CH	GRM1882C1H121JA01D	K22174237		1-	A	C1
C 7605	CHIP CAP.	0.1uF	16V	B	GRM188B11C104KA01D	K22124805		1-	A	B3
C 7606	CHIP CAP.	0.1uF	16V	B	GRM188B11C104KA01D	K22124805		1-	B	b3
C 7607	CHIP CAP.	0.1uF	16V	B	GRM188B11C104KA01D	K22124805		1-	B	c2
C 7608	CHIP CAP.	0.1uF	16V	B	GRM188B11C104KA01D	K22124805		1-	B	b3
C 7609	CHIP CAP.	0.1uF	16V	B	GRM188B11C104KA01D	K22124805		1-	B	b3
C 7610	CHIP CAP.	0.1uF	16V	B	GRM188B11C104KA01D	K22124805		1-	B	b2
C 7611	CHIP CAP.	0.1uF	16V	B	GRM188B11C104KA01D	K22124805		1-	B	b2
C 7612	CHIP CAP.	0.1uF	16V	B	GRM188B11C104KA01D	K22124805		1-	B	b2
C 7613	CHIP TA.CAP.	10uF	16V		TEESVA1C106M8R	K78120077		1-	B	b2
C 7614	CHIP TA.CAP.	10uF	16V		TEESVA1C106M8R	K78120077		1-	B	c2
C 7615	CHIP CAP.	0.1uF	16V	B	GRM188B11C104KA01D	K22124805		1-	B	b2
C 7616	CHIP CAP.	0.1uF	16V	B	GRM188B11C104KA01D	K22124805		1-	B	b2
C 7617	CHIP CAP.	0.1uF	16V	B	GRM188B11C104KA01D	K22124805		1-	B	c2
C 7618	CHIP CAP.	0.1uF	16V	B	GRM188B11C104KA01D	K22124805		1-	A	E1
C 7619	CHIP CAP.	0.1uF	16V	B	GRM188B11C104KA01D	K22124805		1-	A	D1
C 7620	CHIP CAP.	0.1uF	16V	B	GRM188B11C104KA01D	K22124805		1-	B	b3
C 7621	CHIP CAP.	0.1uF	16V	B	GRM188B11C104KA01D	K22124805		1-	B	c2
C 7622	CHIP CAP.	0.1uF	16V	B	GRM188B11C104KA01D	K22124805		1-	B	b2
C 7624	CHIP CAP.	0.1uF	16V	B	GRM188B11C104KA01D	K22124805		1-	B	a1
C 7625	CHIP CAP.	0.1uF	16V	B	GRM188B11C104KA01D	K22124805		1-	B	c2
C 7626	CHIP CAP.	0.1uF	16V	B	GRM188B11C104KA01D	K22124805		1-	B	b2
C 7627	CHIP CAP.	0.1uF	16V	B	GRM188B11C104KA01D	K22124805		1-	B	c2
C 7628	CHIP TA.CAP.	10uF	16V		TEESVA1C106M8R	K78120077		1-	B	b2
C 7629	CHIP CAP.	0.1uF	16V	B	GRM188B11C104KA01D	K22124805		1-	B	c3
C 7630	CHIP CAP.	0.1uF	16V	B	GRM188B11C104KA01D	K22124805		1-	B	a3
C 7631	CHIP TA.CAP.	10uF	16V		TEESVA1C106M8R	K78120077		1-	B	c2
C 7632	CHIP CAP.	0.1uF	16V	B	GRM188B11C104KA01D	K22124805		1-	A	E2
C 7633	CHIP TA.CAP.	10uF	16V		TEESVA1C106M8R	K78120077		1-	B	b2
C 7634	CHIP CAP.	0.1uF	16V	B	GRM188B11C104KA01D	K22124805		1-	B	c3
C 7635	CHIP CAP.	0.1uF	16V	B	GRM188B11C104KA01D	K22124805		1-	A	E2
C 7636	CHIP CAP.	0.1uF	16V	B	GRM188B11C104KA01D	K22124805		1-	A	D3
C 7637	CHIP TA.CAP.	10uF	16V		TEESVA1C106M8R	K78120077		1-	B	b2
C 7638	CHIP CAP.	0.1uF	16V	B	GRM188B11C104KA01D	K22124805		1-	A	D2
C 7639	CHIP CAP.	0.1uF	16V	B	GRM188B11C104KA01D	K22124805		1-	B	c2
C 7640	CHIP TA.CAP.	10uF	16V		TEESVA1C106M8R	K78120077		1-	B	c2
C 7641	CHIP CAP.	0.1uF	16V	B	GRM188B11C104KA01D	K22124805		1-	B	c2
C 7642	CHIP CAP.	0.1uF	16V	B	GRM188B11C104KA01D	K22124805		1-	B	b2
C 7643	CHIP CAP.	0.1uF	16V	B	GRM188B11C104KA01D	K22124805		1-	B	b2
C 7644	CHIP CAP.	0.1uF	16V	B	GRM188B11C104KA01D	K22124805		1-	B	c2
C 7645	CHIP CAP.	0.1uF	16V	B	GRM188B11C104KA01D	K22124805		1-	B	c2
C 7646	CHIP CAP.	0.1uF	16V	B	GRM188B11C104KA01D	K22124805		1-	B	b2
C 7647	CHIP CAP.	0.1uF	16V	B	GRM188B11C104KA01D	K22124805		1-	B	b2

DSP Unit (Lot.1~42)

Parts List

REF	DESCRIPTION	VALUE	V/W	TOL.	MFR'S DESIG	VXSTD P/N	VERS.	LOT	SIDE	LAY ADR
C 7648	CHIP CAP.	0.1uF	16V	B	GRM188B11C104KA01D	K22124805		1-	A	E2
C 7649	CHIP TA.CAP.	10uF	16V		TEESVA1C106M8R	K78120077		1-	B	c2
C 7650	CHIP TA.CAP.	10uF	16V		TEESVA1C106M8R	K78120077		1-	B	c2
C 7651	CHIP CAP.	0.1uF	16V	B	GRM188B11C104KA01D	K22124805		1-	A	D2
C 7652	CHIP CAP.	0.1uF	16V	B	GRM188B11C104KA01D	K22124805		1-	A	B2
D 7501	LED				SML-310VTT86JK	G2071032		1-	A	C3
D 7502	LED				SML-310VTT86JK	G2071032		1-	A	C3
FB7501	CHIP COI				BLM18BD182SN1D	L1690602		1-	A	E2
FB7502	CHIP COI				BLM18BD182SN1D	L1690602		1-	A	E2
FB7503	CHIP COI				BLM18BD182SN1D	L1690602		1-	A	E2
FB7504	CHIP COI				BLM18BD182SN1D	L1690602		1-	A	E2
FB7505	FERRITE BEADS				BK2125HS101-T	L9190087		1-	B	a2
J 7501	CONNECTOR				SB20-08WL	P0090847		1-	A	A1
J 7502	CONNECTOR				18FLT-SM2-TB(LF)(SN)	P1091176		1-	A	E2
L 7501	M.RFC	470uH			CDRH105RNP-471NC-VS	L1691359		1-	A	B1
L 7502	M.RFC	470uH			CDRH105RNP-471NC-VS	L1691359		1-	A	B1
L 7503	CHIP COIL	6.2uH			CDRH5D28NP-6R2NC	L1691444		1-	A	C1
L 7504	CHIP COIL	6.2uH			CDRH5D28NP-6R2NC	L1691444		1-	A	B2
Q 7501	IC				NJM78L05UA-TE1	G1091325		1-	A	B3
Q 7502	IC				SN74LVC244APWR	G1094336		1-	A	C1
Q 7503	IC				CS4272-CZZ	G1094319		1-	A	B2
Q 7504	IC				AD5541JR	G1094335		1-	A	B2
Q 7505	IC				EPM3064ATC100-7N	G1094320		1-	A	D1
Q 7506	IC				ST16C550CQ48-F	G1094323		1-	A	D1
Q 7507	IC				TPS62040DGQ	G1094328		1-	A	C1
Q 7508	IC				TPS62046DGQ	G1094329		1-	A	B1
Q 7509	IC				NJM2068V-TE1	G1094112		1-	A	A1
Q 7510	IC				NJM2068V-TE1	G1094112		1-	A	A2
Q 7511	IC				NJM2068V-TE1	G1094112		1-	A	A2
Q 7512	IC				NJM2068V-TE1	G1094112		1-	A	A2
Q 7513	IC				NJM2068V-TE1	G1094112		1-	A	A3
Q 7514	IC				NJM2068V-TE1	G1094112		1-	A	B2
Q 7515	IC				SN74LVC245APWR	G1094337		1-	A	C1
Q 7516	IC				TPS3808G50	G1094327		1-	A	C1
Q 7517	IC				TPS3808G33	G1094326		1-	A	B2
Q 7518	IC				TPS3808G01	G1094325		1-	A	C1
Q 7519	IC				TMS320C6713BZDP-225	G1094324		1-	A	C2
Q 7520	IC				IS42S16800B-7TL	G1094321		1-	A	D2
Q 7521	IC				M29LV400TC-90PFTN	G1094318		1-	A	D2
R 7501	CHIP RES.	0	1/16W	5%	RMC1/16 000JATP	J24185000		1-	A	A1
R 7502	CHIP RES.	0	1/16W	5%	RMC1/16 000JATP	J24185000		1-	A	A3
R 7503	CHIP RES.	47k	1/16W	1%	RMC1/16 473FTP	J24183473		1-	A	A1
R 7504	CHIP RES.	1k	1/16W	1%	RMC1/16 102FTP	J24183102		1-	A	A1
R 7505	CHIP RES.	1k	1/16W	1%	RMC1/16 102FTP	J24183102		1-	A	A2
R 7506	CHIP RES.	1k	1/16W	1%	RMC1/16 102FTP	J24183102		1-	A	A2
R 7507	CHIP RES.	47k	1/16W	1%	RMC1/16 473FTP	J24183473		1-	A	A2
R 7508	CHIP RES.	47k	1/16W	1%	RMC1/16 473FTP	J24183473		1-	A	A3
R 7509	CHIP RES.	100	1/16W	1%	RMC1/16 101FTP	J24183101		1-	A	A2
R 7510	CHIP RES.	1k	1/16W	1%	RMC1/16 102FTP	J24183102		1-	A	A2
R 7511	CHIP RES.	0	1/16W	5%	RMC1/16 000JATP	J24185000		1-	A	A1
R 7512	CHIP RES.	0	1/16W	5%	RMC1/16 000JATP	J24185000		1-	A	B2
R 7513	CHIP RES.	1.5k	1/16W	1%	RMC1/16 152FTP	J24183152		1-	A	B1
R 7514	CHIP RES.	15k	1/16W	1%	RMC1/16 153FTP	J24183153		1-	A	A1
R 7515	CHIP RES.	15k	1/16W	1%	RMC1/16 153FTP	J24183153		1-	A	A2
R 7516	CHIP RES.	0	1/16W	5%	RMC1/16 000JATP	J24185000		1-	A	B2
R 7517	CHIP RES.	0	1/16W	5%	RMC1/16 000JATP	J24185000		1-	A	B1
R 7518	CHIP RES.	7.5k	1/16W	1%	RMC1/16 752FTP	J24183752		1-	A	B1
R 7519	CHIP RES.	4.7k	1/16W	1%	RMC1/16 472FTP	J24183472		1-	A	A2
R 7520	CHIP RES.	4.7k	1/16W	1%	RMC1/16 472FTP	J24183472		1-	A	A2
R 7521	CHIP RES.	22k	1/16W	1%	RMC1/16 223FTP	J24183223		1-	A	A1
R 7522	CHIP RES.	10k	1/16W	1%	RMC1/16 103FTP	J24183103		1-	A	A2
R 7523	CHIP RES.	0	1/16W	5%	RMC1/16 000JATP	J24185000		1-	A	B1
R 7524	CHIP RES.	0	1/16W	5%	RMC1/16 000JATP	J24185000		1-	A	A3
R 7525	CHIP RES.	4.7k	1/16W	1%	RMC1/16 472FTP	J24183472		1-	A	A3
R 7526	CHIP RES.	4.7k	1/16W	1%	RMC1/16 472FTP	J24183472		1-	A	A2
R 7527	CHIP RES.	5.6k	1/16W	1%	RMC1/16 562FTP	J24183562		1-	A	A1
R 7528	CHIP RES.	5.6k	1/16W	1%	RMC1/16 562FTP	J24183562		1-	A	A2
R 7529	CHIP RES.	4.7k	1/16W	1%	RMC1/16 472FTP	J24183472		1-	A	A2
R 7530	CHIP RES.	4.7k	1/16W	1%	RMC1/16 472FTP	J24183472		1-	A	A2
R 7531	CHIP RES.	4.7k	1/16W	1%	RMC1/16 472FTP	J24183472		1-	A	A3
R 7532	CHIP RES.	4.7k	1/16W	1%	RMC1/16 472FTP	J24183472		1-	A	A2
R 7533	CHIP RES.	4.7k	1/16W	1%	RMC1/16 472FTP	J24183472		1-	A	A2
R 7534	CHIP RES.	4.7k	1/16W	1%	RMC1/16 472FTP	J24183472		1-	A	A2

DSP Unit (Lot.1~42)

Parts List

REF	DESCRIPTION	VALUE	V/W	TOL.	MFR'S DESIG	VXSTD P/N	VERS.	LOT	SIDE	LAY ADR
R 7535	CHIP RES.	4.7k	1/16W	1%	RMC1/16 472FTP	J24183472		1-	A	A1
R 7536	CHIP RES.	4.7k	1/16W	1%	RMC1/16 472FTP	J24183472		1-	A	A2
R 7537	CHIP RES.	4.7k	1/16W	1%	RMC1/16 472FTP	J24183472		1-	A	A2
R 7538	CHIP RES.	4.7k	1/16W	1%	RMC1/16 472FTP	J24183472		1-	A	A2
R 7539	CHIP RES.	1k	1/16W	1%	RMC1/16 102FTP	J24183102		1-	A	A2
R 7540	CHIP RES.	2.2k	1/16W	1%	RMC1/16 222FTP	J24183222		1-	A	A1
R 7541	CHIP RES.	2.2k	1/16W	1%	RMC1/16 222FTP	J24183222		1-	A	A2
R 7542	CHIP RES.	1k	1/16W	1%	RMC1/16 102FTP	J24183102		1-	A	A2
R 7543	CHIP RES.	1k	1/16W	1%	RMC1/16 102FTP	J24183102		1-	A	A3
R 7544	CHIP RES.	1k	1/16W	1%	RMC1/16 102FTP	J24183102		1-	A	A2
R 7545	CHIP RES.	1k	1/16W	1%	RMC1/16 102FTP	J24183102		1-	A	A2
R 7546	CHIP RES.	4.7k	1/16W	1%	RMC1/16 472FTP	J24183472		1-	A	A1
R 7547	CHIP RES.	4.7k	1/16W	1%	RMC1/16 472FTP	J24183472		1-	A	A2
R 7548	CHIP RES.	470	1/16W	1%	RMC1/16 471FTP	J24183471		1-	A	A2
R 7549	CHIP RES.	470	1/16W	1%	RMC1/16 471FTP	J24183471		1-	A	A2
R 7550	CHIP RES.	470	1/16W	1%	RMC1/16 471FTP	J24183471		1-	A	A3
R 7551	CHIP RES.	470	1/16W	1%	RMC1/16 471FTP	J24183471		1-	A	A2
R 7552	CHIP RES.	1k	1/16W	1%	RMC1/16 102FTP	J24183102		1-	A	A1
R 7553	CHIP RES.	1k	1/16W	1%	RMC1/16 102FTP	J24183102		1-	A	A1
R 7554	CHIP RES.	1k	1/16W	1%	RMC1/16 102FTP	J24183102		1-	A	A2
R 7555	CHIP RES.	1k	1/16W	1%	RMC1/16 102FTP	J24183102		1-	A	A2
R 7556	CHIP RES.	1.5k	1/16W	1%	RMC1/16 152FTP	J24183152		1-	A	A2
R 7557	CHIP RES.	1.5k	1/16W	1%	RMC1/16 152FTP	J24183152		1-	A	A2
R 7558	CHIP RES.	1.5k	1/16W	1%	RMC1/16 152FTP	J24183152		1-	A	A3
R 7559	CHIP RES.	1.5k	1/16W	1%	RMC1/16 152FTP	J24183152		1-	A	A2
R 7560	CHIP RES.	10	1/16W	5%	RMC1/16 100JATP	J24185100		1-	A	B2
R 7563	CHIP RES.	4.7k	1/16W	5%	RMC1/16 472JATP	J24185472		1-	B	a1
R 7564	CHIP RES.	4.7k	1/16W	5%	RMC1/16 472JATP	J24185472		1-	B	a1
R 7565	CHIP RES.	1k	1/16W	5%	RMC1/16 102JATP	J24185102		1-	A	C1
R 7566	CHIP RES.	4.7k	1/16W	5%	RMC1/16 472JATP	J24185472		1-	A	B2
R 7568	CHIP RES.	1k	1/16W	5%	RMC1/16 102JATP	J24185102		1-	A	C1
R 7570	CHIP RES.	4.7k	1/16W	5%	RMC1/16 472JATP	J24185472		1-	A	D1
R 7571	CHIP RES.	4.7k	1/16W	5%	RMC1/16 472JATP	J24185472		1-	B	a1
R 7572	CHIP RES.	4.7k	1/16W	5%	RMC1/16 472JATP	J24185472		1-	B	a1
R 7573	CHIP RES.	33	1/16W	5%	RMC1/16 330JATP	J24185330		1-	B	a1
R 7574	CHIP RES.	33	1/16W	5%	RMC1/16 330JATP	J24185330		1-	B	a1
R 7576	CHIP RES.	4.7k	1/16W	5%	RMC1/16 472JATP	J24185472		1-	A	B2
R 7578	CHIP RES.	4.7k	1/16W	5%	RMC1/16 472JATP	J24185472		1-	A	B2
R 7579	CHIP RES.	4.7k	1/16W	5%	RMC1/16 472JATP	J24185472		1-	A	B2
R 7580	CHIP RES.	33	1/16W	5%	RMC1/16 330JATP	J24185330		1-	A	D1
R 7581	CHIP RES.	4.7k	1/16W	5%	RMC1/16 472JATP	J24185472		1-	B	b1
R 7583	CHIP RES.	10k	1/16W	5%	RMC1/16 103JATP	J24185103		1-	A	C1
R 7584	CHIP RES.	10k	1/16W	5%	RMC1/16 103JATP	J24185103		1-	A	C1
R 7585	CHIP RES.	47k	1/16W	1%	RMC1/16 473FTP	J24183473		1-	A	C1
R 7586	CHIP RES.	470k	1/16W	1%	RMC1/16 474FTP	J24183474		1-	A	C1
R 7587	CHIP RES.	270k	1/16W	1%	RMC1/16 274FTP	J24183274		1-	A	C1
R 7588	CHIP RES.	39k	1/16W	1%	RMC1/16 393FTP	J24183393		1-	A	C1
R 7589	CHIP RES.	10k	1/16W	5%	RMC1/16 103JATP	J24185103		1-	A	B2
R 7591	CHIP RES.	180k	1/16W	5%	RMC1/16 184JATP	J24185184		1-	A	C1
R 7592	CHIP RES.	2.2k	1/16W	5%	RMC1/16 222JATP	J24185222		1-	A	C1
R 7593	CHIP RES.	100k	1/16W	5%	RMC1/16 104JATP	J24185104		1-	A	C1
R 7596	CHIP RES.	4.7k	1/16W	5%	RMC1/16 472JATP	J24185472		1-	A	C2
R 7597	CHIP RES.	1k	1/16W	5%	RMC1/16 102JATP	J24185102		1-	B	b1
R 7598	CHIP RES.	1k	1/16W	5%	RMC1/16 102JATP	J24185102		1-	B	b1
R 7599	CHIP RES.	1k	1/16W	5%	RMC1/16 102JATP	J24185102		1-	A	E1
R 7602	CHIP RES.	4.7k	1/16W	5%	RMC1/16 472JATP	J24185472		1-	A	C2
R 7604	CHIP RES.	4.7k	1/16W	5%	RMC1/16 472JATP	J24185472		1-	B	a2
R 7605	CHIP RES.	4.7k	1/16W	5%	RMC1/16 472JATP	J24185472		1-	A	C2
R 7606	CHIP RES.	4.7k	1/16W	5%	RMC1/16 472JATP	J24185472		1-	A	E1
R 7607	CHIP RES.	4.7k	1/16W	5%	RMC1/16 472JATP	J24185472		1-	A	E1
R 7608	CHIP RES.	4.7k	1/16W	5%	RMC1/16 472JATP	J24185472		1-	A	E1
R 7609	CHIP RES.	4.7k	1/16W	5%	RMC1/16 472JATP	J24185472		1-	A	E1
R 7610	CHIP RES.	4.7k	1/16W	5%	RMC1/16 472JATP	J24185472		1-	B	a1
R 7611	CHIP RES.	4.7k	1/16W	5%	RMC1/16 472JATP	J24185472		1-	B	a1
R 7612	CHIP RES.	4.7k	1/16W	5%	RMC1/16 472JATP	J24185472		1-	A	E2
R 7614	CHIP RES.	4.7k	1/16W	5%	RMC1/16 472JATP	J24185472		1-	B	a2
R 7616	CHIP RES.	4.7k	1/16W	5%	RMC1/16 472JATP	J24185472		1-	B	a2
R 7618	CHIP RES.	4.7k	1/16W	5%	RMC1/16 472JATP	J24185472		1-	A	E1
R 7619	CHIP RES.	4.7k	1/16W	5%	RMC1/16 472JATP	J24185472		1-	A	E1
R 7620	CHIP RES.	4.7k	1/16W	5%	RMC1/16 472JATP	J24185472		1-	A	E1
R 7621	CHIP RES.	4.7k	1/16W	5%	RMC1/16 472JATP	J24185472		1-	B	a1
R 7622	CHIP RES.	4.7k	1/16W	5%	RMC1/16 472JATP	J24185472		1-	B	a1
R 7623	CHIP RES.	4.7k	1/16W	5%	RMC1/16 472JATP	J24185472		1-	A	C3

DSP Unit (Lot.1~42)

Parts List

REF	DESCRIPTION	VALUE	V/W	TOL.	MFR'S DESIG	VXSTD P/N	VERS.	LOT	SIDE	LAY ADR
R 7624	CHIP RES.	4.7k	1/16W	5%	RMC1/16 472JATP	J24185472		1-	A	C3
R 7625	CHIP RES.	1k	1/16W	5%	RMC1/16 102JATP	J24185102		1-	A	C2
R 7626	CHIP RES.	3.3k	1/16W	5%	RMC1/16 332JATP	J24185332		1-	A	B3
R 7627	CHIP RES.	3.3k	1/16W	5%	RMC1/16 332JATP	J24185332		1-	A	B3
R 7628	CHIP RES.	4.7k	1/16W	5%	RMC1/16 472JATP	J24185472		1-	A	C2
R 7630	CHIP RES.	0	1/16W	5%	RMC1/16 000JATP	J24185000		1-	A	D1
R 7631	CHIP RES.	4.7k	1/16W	5%	RMC1/16 472JATP	J24185472		1-	A	D3
R 7632	CHIP RES.	4.7k	1/16W	5%	RMC1/16 472JATP	J24185472		1-	A	D1
R 7633	CHIP RES.	4.7k	1/16W	5%	RMC1/16 472JATP	J24185472		1-	A	D1
R 7634	CHIP RES.	0	1/16W	5%	RMC1/16 000JATP	J24185000		1-	A	D2
R 7636	CHIP RES.	33	1/16W	5%	RMC1/16 330JATP	J24185330		1-	A	C2
R 7637	CHIP RES.	33	1/16W	5%	RMC1/16 330JATP	J24185330		1-	A	D1
S 7501	TACT SWITCH				SKQYPAE010	N5090144		1-	A	C1
X 7501	XTAL OSC	24.999MHz			TPS18XC-E1 24.9990MHZ	H9501020		1-	A	B3
X 7502	XTAL OSC	18.432MHz			TPS18XC-E1 18.432MHZ	H9501010		1-	A	D1

DSP Unit (Lot.1~42)

Note:

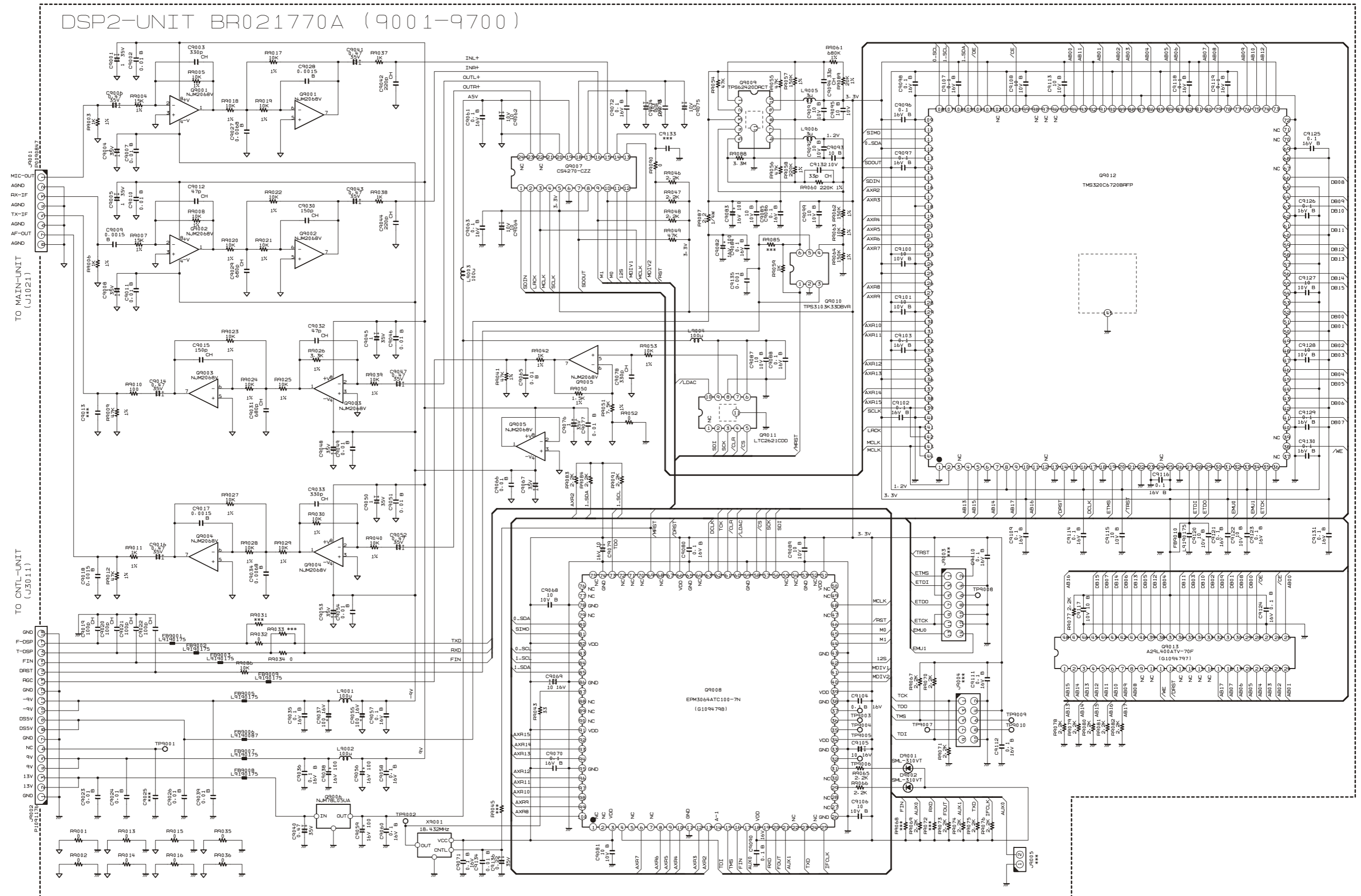

DSP2 Unit (Lot.43~)

Note

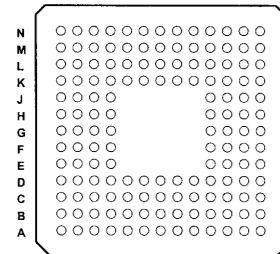
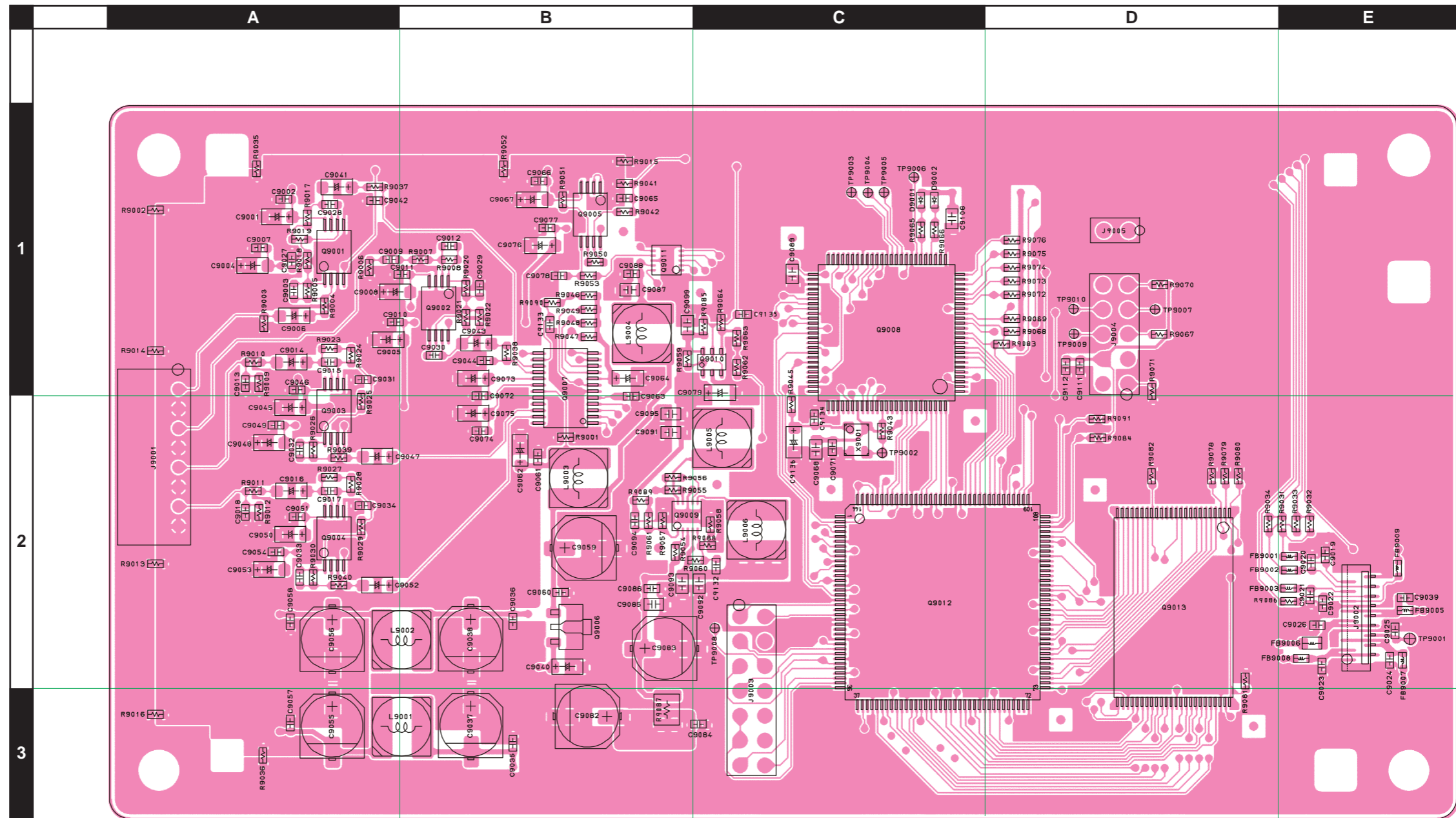

Bottom View

TMS320C6713BZDP (Q7519)

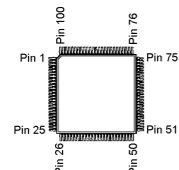

EPM3064ATC100 (Q7505)

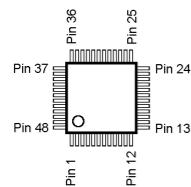

ST16C550CQ48-F (Q7506)

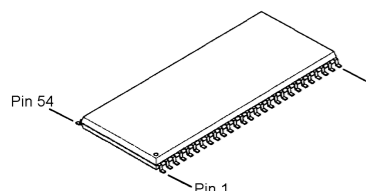

IS42S16800B (Q7520)

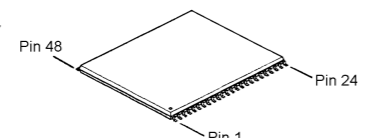

M29LV400TC (Q7521)

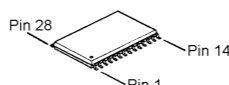

CS4272 (Q7503)

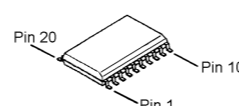

SN74LVC244PWR (Q7502)

SN74LVC245PWR (Q7515)

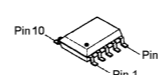

TPS62040DGQ (Q7507)

TPS62046DGQ (Q7508)



AD5541JR (Q7504)

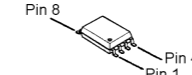

NJM2068V (Q7509, 7510, 7511, 7512, 7513, 7514)

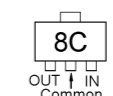

NJM75L05UA (8C) (Q7501)

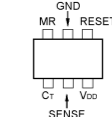

TPS3808G01 (Q7518)

TPS3808G33 (Q7517)

TPS3808G50 (Q7516)

DSP2 Unit (Lot.43~)

Parts Layout (Side B)

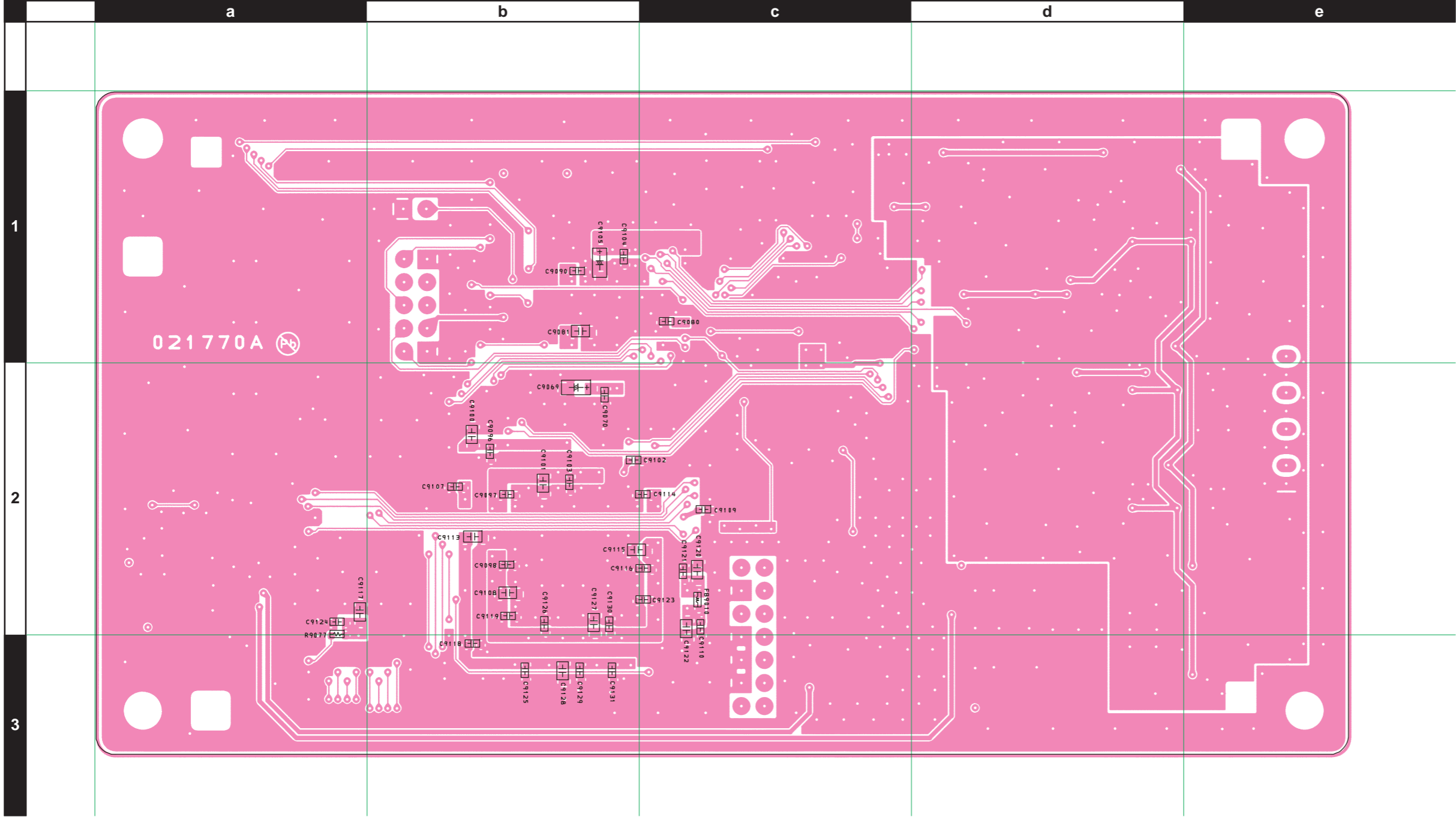

DSP2 Unit (Lot.43~)

Parts List

REF	DESCRIPTION	VALUE	V/W	TOL.	MFR'S DESIG	VXSTD P/N	VERS.	LOT	SIDE	LAY ADR
PCB with Components						CS2090501				
	Printed Circuit Board					FR021770A		43-		
C 9001	CHIP TA.CAP.	1uF	35V		TEESVA1V105M8R	K78160032		1-	A	A1
C 9002	CHIP CAP.	0.01uF	50V	B	GRM188B11H103KA01D	K22174823		1-	A	A1
C 9003	CHIP CAP.	330pF	50V	CH	GRM1882C1H331JA01D	K22174253		1-	A	A1
C 9004	CHIP TA.CAP.	1uF	35V		TEESVA1V105M8R	K78160032		1-	A	A1
C 9005	CHIP TA.CAP.	1uF	35V		TEESVA1V105M8R	K78160032		1-	A	B2
C 9006	CHIP TA.CAP.	0.47uF	35V		TEESVA1V474M8R	K78160029		1-	A	A2
C 9007	CHIP CAP.	0.01uF	50V	B	GRM188B11H103KA01D	K22174823		1-	A	A1
C 9008	CHIP TA.CAP.	1uF	35V		TEESVA1V105M8R	K78160032		1-	A	B1
C 9009	CHIP CAP.	0.0015uF	50V	B	GRM188B11H152KA01D	K22174827		1-	A	B1
C 9010	CHIP CAP.	0.01uF	50V	B	GRM188B11H103KA01D	K22174823		1-	A	B2
C 9011	CHIP CAP.	0.01uF	50V	B	GRM188B11H103KA01D	K22174823		1-	A	B1
C 9012	CHIP CAP.	47pF	50V	CH	GRM1882C1H470JA01D	K22174227		1-	A	B1
C 9014	CHIP TA.CAP.	0.47uF	35V		TEESVA1V474M8R	K78160029		1-	A	A2
C 9015	CHIP CAP.	150pF	50V	CH	GRM1882C1H151JA01D	K22174239		1-	A	B2
C 9016	CHIP TA.CAP.	0.47uF	35V		TEESVA1V474M8R	K78160029		1-	A	A2
C 9017	CHIP CAP.	0.0015uF	50V	B	GRM188B11H152KA01D	K22174827		1-	A	B2
C 9018	CHIP CAP.	0.0015uF	50V	B	GRM188B11H152KA01D	K22174827		1-	A	A3
C 9019	CHIP CAP.	100pF	50V	CH	GRM1882C1H101JA01D	K22174235		1-	A	G3
C 9020	CHIP CAP.	100pF	50V	CH	GRM1882C1H101JA01D	K22174235		1-	A	G3
C 9021	CHIP CAP.	100pF	50V	CH	GRM1882C1H101JA01D	K22174235		1-	A	G3
C 9022	CHIP CAP.	100pF	50V	CH	GRM1882C1H101JA01D	K22174235		1-	A	G3
C 9023	CHIP CAP.	0.01uF	50V	B	GRM188B11H103KA01D	K22174823		1-	A	G3
C 9024	CHIP CAP.	0.01uF	50V	B	GRM188B11H103KA01D	K22174823		1-	A	G3
C 9026	CHIP CAP.	0.01uF	50V	B	GRM188B11H103KA01D	K22174823		1-	A	G3
C 9027	CHIP CAP.	0.0068uF	50V	B	GRM188B11H682KA01D	K22174819		1-	A	A1
C 9028	CHIP CAP.	0.0015uF	50V	B	GRM188B11H152KA01D	K22174827		1-	A	B1
C 9029	CHIP CAP.	680pF	50V	CH	GRM1882C1H681JA01D	K22174274		1-	A	B1
C 9030	CHIP CAP.	150pF	50V	CH	GRM1882C1H151JA01D	K22174239		1-	A	B2
C 9031	CHIP CAP.	680pF	50V	CH	GRM1882C1H681JA01D	K22174274		1-	A	B2
C 9032	CHIP CAP.	47pF	50V	CH	GRM1882C1H470JA01D	K22174227		1-	A	A2
C 9033	CHIP CAP.	330pF	50V	CH	GRM1882C1H331JA01D	K22174253		1-	A	A3
C 9034	CHIP CAP.	0.0068uF	50V	B	GRM188B11H682KA01D	K22174819		1-	A	B3
C 9035	CHIP CAP.	0.1uF	16V	B	GRM188B11C104KA01D	K22124805		1-	A	C4
C 9036	CHIP CAP.	0.1uF	16V	B	GRM188B11C104KA01D	K22124805		1-	A	C3
C 9037	AL.ELECTRO.CAP.	100uF	16V		EEE1CA101WP	K48120012		1-	A	B4
C 9038	AL.ELECTRO.CAP.	100uF	16V		EEE1CA101WP	K48120012		1-	A	B3
C 9039	CHIP CAP.	0.01uF	50V	B	GRM188B11H103KA01D	K22174823		1-	A	G3
C 9040	CHIP TA.CAP.	0.47uF	35V		TEESVA1V474M8R	K78160029		1-	A	C3
C 9041	CHIP TA.CAP.	0.47uF	35V		TEESVA1V474M8R	K78160029		1-	A	B1
C 9042	CHIP CAP.	220pF	50V	CH	GRM1882C1H221JA01D	K22174243		1-	A	B1
C 9043	CHIP TA.CAP.	0.47uF	35V		TEESVA1V474M8R	K78160029		1-	A	B2
C 9044	CHIP CAP.	220pF	50V	CH	GRM1882C1H221JA01D	K22174243		1-	A	B2
C 9045	CHIP TA.CAP.	1uF	35V		TEESVA1V105M8R	K78160032		1-	A	A2
C 9046	CHIP CAP.	0.01uF	50V	B	GRM188B11H103KA01D	K22174823		1-	A	A2
C 9047	CHIP TA.CAP.	0.47uF	35V		TEESVA1V474M8R	K78160029		1-	A	B2
C 9048	CHIP TA.CAP.	1uF	35V		TEESVA1V105M8R	K78160032		1-	A	A2
C 9049	CHIP CAP.	0.01uF	50V	B	GRM188B11H103KA01D	K22174823		1-	A	A2
C 9050	CHIP TA.CAP.	1uF	35V		TEESVA1V105M8R	K78160032		1-	A	A3
C 9051	CHIP CAP.	0.01uF	50V	B	GRM188B11H103KA01D	K22174823		1-	A	A3
C 9052	CHIP TA.CAP.	0.47uF	35V		TEESVA1V474M8R	K78160029		1-	A	B3
C 9053	CHIP TA.CAP.	1uF	35V		TEESVA1V105M8R	K78160032		1-	A	A3
C 9054	CHIP CAP.	0.01uF	50V	B	GRM188B11H103KA01D	K22174823		1-	A	A3
C 9055	AL.ELECTRO.CAP.	100uF	16V		EEE1CA101WP	K48120012		1-	A	B4
C 9056	AL.ELECTRO.CAP.	100uF	16V		EEE1CA101WP	K48120012		1-	A	B3
C 9057	CHIP CAP.	0.1uF	16V	B	GRM188B11C104KA01D	K22124805		1-	A	A4
C 9058	CHIP CAP.	0.1uF	16V	B	GRM188B11C104KA01D	K22124805		1-	A	A3
C 9059	AL.ELECTRO.CAP.	100uF	16V		EEE1CA101WP	K48120012		1-	A	C3
C 9060	CHIP CAP.	0.1uF	16V	B	GRM188B11C104KA01D	K22124805		1-	A	C3
C 9061	CHIP CAP.	0.1uF	16V	B	GRM188B11C104KA01D	K22124805		1-	A	C2
C 9062	CHIP TA.CAP.	10uF	10V		TEESVA1A106M8R	K78100028		1-	A	C2
C 9063	CHIP CAP.	0.1uF	16V	B	GRM188B11C104KA01D	K22124805		1-	A	C2
C 9064	CHIP TA.CAP.	10uF	10V		TEESVA1A106M8R	K78100028		1-	A	C2
C 9065	CHIP CAP.	0.01uF	50V	B	GRM188B11H103JA01D	K22174824		1-	A	C1
C 9066	CHIP CAP.	0.01uF	50V	B	GRM188B11H103KA01D	K22174823		1-	A	C1
C 9067	CHIP TA.CAP.	1uF	35V		TEESVA1V105M8R	K78160032		1-	A	C1
C 9068	CHIP CAP.	10uF	10V	B	GRM21BB31A106KE18L	K22100808		1-	A	D2
C 9069	CHIP TA.CAP.	10uF	16V		TEESVA1C106M8R	K78120077		1-	B	c2
C 9070	CHIP CAP.	0.1uF	16V	B	GRM188B11C104KA01D	K22124805		1-	B	c2
C 9071	CHIP CAP.	0.1uF	16V	B	GRM188B11C104KA01D	K22124805		1-	A	D2
C 9072	CHIP CAP.	0.1uF	16V	B	GRM188B11C104KA01D	K22124805		1-	A	B2
C 9073	CHIP TA.CAP.	10uF	10V		TEESVA1A106M8R	K78100028		1-	A	B2

DSP2 Unit (Lot.43~)

Parts List

REF	DESCRIPTION	VALUE	V/W	TOL.	MFR'S DESIG	VXSTD P/N	VERS.	LOT	SIDE	LAY ADR
C 9074	CHIP CAP.	0.1uF	16V	B	GRM188B11C104KA01D	K22124805		1-	A	B2
C 9075	CHIP TA.CAP.	10uF	10V		TEESVA1A106M8R	K78100028		1-	A	B2
C 9076	CHIP TA.CAP.	1uF	35V		TEESVA1V105M8R	K78160032		1-	A	C1
C 9077	CHIP CAP.	0.01uF	50V	B	GRM188B11H103KA01D	K22174823		1-	A	C1
C 9078	CHIP CAP.	330pF	50V	CH	GRM1882C1H331JA01D	K22174253		1-	A	C1
C 9079	CHIP TA.CAP.	10uF	16V		TEESVA1C106M8R	K78120077		1-	A	D2
C 9080	CHIP CAP.	0.1uF	16V	B	GRM188B11C104KA01D	K22124805		1-	B	d2
C 9081	CHIP CAP.	10uF	10V	B	GRM21BB31A106KE18L	K22100808		1-	B	c2
C 9082	AL.ELECTRO.CAP.	100uF	16V		EEE1CA101WP	K48120012		1-	A	C4
C 9083	AL.ELECTRO.CAP.	100uF	16V		EEE1CA101WP	K48120012		1-	A	C3
C 9084	CHIP CAP.	0.1uF	16V	B	GRM188B11C104KA01D	K22124805		1-	A	D4
C 9085	CHIP CAP.	10uF	10V	B	GRM21BB31A106KE18L	K22100808		1-	A	C3
C 9086	CHIP CAP.	0.1uF	16V	B	GRM188B11C104KA01D	K22124805		1-	A	C3
C 9087	CHIP CAP.	10uF	10V	B	GRM21BB31A106KE18L	K22100808		1-	A	C1
C 9088	CHIP CAP.	0.1uF	16V	B	GRM188B11C104KA01D	K22124805		1-	A	C1
C 9089	CHIP CAP.	10uF	10V	B	GRM21BB31A106KE18L	K22100808		1-	A	D1
C 9090	CHIP CAP.	0.1uF	16V	B	GRM188B11C104KA01D	K22124805		1-	B	c1
C 9091	CHIP CAP.	10uF	10V	B	GRM21BB31A106KE18L	K22100808		1-	A	C2
C 9092	CHIP CAP.	10uF	10V	B	GRM21BB31A106KE18L	K22100808		1-	A	D3
C 9093	CHIP CAP.	10uF	10V	B	GRM21BB31A106KE18L	K22100808		1-	A	C3
C 9094	CHIP CAP.	33pF	50V	CH	GRM1882C1H330JA01D	K22174223		1-	A	C3
C 9095	CHIP CAP.	10uF	10V	B	GRM21BB31A106KE18L	K22100808		1-	A	C2
C 9096	CHIP CAP.	0.1uF	16V	B	GRM188B11C104KA01D	K22124805		1-	B	c2
C 9097	CHIP CAP.	0.1uF	16V	B	GRM188B11C104KA01D	K22124805		1-	B	c3
C 9098	CHIP CAP.	0.1uF	16V	B	GRM188B11C104KA01D	K22124805		1-	B	c3
C 9099	CHIP CAP.	10uF	10V	B	GRM21BB31A106KE18L	K22100808		1-	A	C2
C 9100	CHIP CAP.	10uF	10V	B	GRM21BB31A106KE18L	K22100808		1-	B	c2
C 9101	CHIP CAP.	10uF	10V	B	GRM21BB31A106KE18L	K22100808		1-	B	c3
C 9102	CHIP CAP.	0.1uF	16V	B	GRM188B11C104KA01D	K22124805		1-	B	c3
C 9103	CHIP CAP.	0.1uF	16V	B	GRM188B11C104KA01D	K22124805		1-	B	c3
C 9104	CHIP CAP.	0.1uF	16V	B	GRM188B11C104KA01D	K22124805		1-	B	c1
C 9105	CHIP TA.CAP.	10uF	16V		TEESVA1C106M8R	K78120077		1-	B	c1
C 9106	CHIP CAP.	10uF	10V	B	GRM21BB31A106KE18L	K22100808		1-	A	E1
C 9107	CHIP CAP.	0.1uF	16V	B	GRM188B11C104KA01D	K22124805		1-	B	b3
C 9108	CHIP CAP.	10uF	10V	B	GRM21BB31A106KE18L	K22100808		1-	B	c3
C 9109	CHIP CAP.	0.1uF	16V	B	GRM188B11C104KA01D	K22124805		1-	B	d3
C 9110	CHIP CAP.	0.1uF	16V	B	GRM188B11C104KA01D	K22124805		1-	B	d3
C 9111	CHIP CAP.	0.1uF	16V	B	GRM188B11C104KA01D	K22124805		1-	A	E2
C 9112	CHIP CAP.	0.1uF	16V	B	GRM188B11C104KA01D	K22124805		1-	A	E2
C 9113	CHIP CAP.	10uF	10V	B	GRM21BB31A106KE18L	K22100808		1-	B	c3
C 9114	CHIP CAP.	0.1uF	16V	B	GRM188B11C104KA01D	K22124805		1-	B	d3
C 9115	CHIP CAP.	10uF	10V	B	GRM21BB31A106KE18L	K22100808		1-	B	c3
C 9116	CHIP CAP.	0.1uF	16V	B	GRM188B11C104KA01D	K22124805		1-	B	d3
C 9117	CHIP CAP.	10uF	10V	B	GRM21BB31A106KE18L	K22100808		1-	B	b3
C 9118	CHIP CAP.	0.1uF	16V	B	GRM188B11C104KA01D	K22124805		1-	B	c4
C 9119	CHIP CAP.	0.1uF	16V	B	GRM188B11C104KA01D	K22124805		1-	B	c3
C 9120	CHIP CAP.	10uF	10V	B	GRM21BB31A106KE18L	K22100808		1-	B	d3
C 9121	CHIP CAP.	0.1uF	16V	B	GRM188B11C104KA01D	K22124805		1-	B	d3
C 9122	CHIP CAP.	10uF	10V	B	GRM21BB31A106KE18L	K22100808		1-	B	d3
C 9123	CHIP CAP.	0.1uF	16V	B	GRM188B11C104KA01D	K22124805		1-	B	d3
C 9124	CHIP CAP.	0.1uF	16V	B	GRM188B11C104KA01D	K22124805		1-	B	b3
C 9125	CHIP CAP.	0.1uF	16V	B	GRM188B11C104KA01D	K22124805		1-	B	c4
C 9126	CHIP CAP.	0.1uF	16V	B	GRM188B11C104KA01D	K22124805		1-	B	c3
C 9127	CHIP CAP.	10uF	10V	B	GRM21BB31A106KE18L	K22100808		1-	B	c3
C 9128	CHIP CAP.	10uF	10V	B	GRM21BB31A106KE18L	K22100808		1-	B	c4
C 9129	CHIP CAP.	0.1uF	16V	B	GRM188B11C104KA01D	K22124805		1-	B	c4
C 9130	CHIP CAP.	0.1uF	16V	B	GRM188B11C104KA01D	K22124805		1-	B	c3
C 9131	CHIP CAP.	0.1uF	16V	B	GRM188B11C104KA01D	K22124805		1-	B	c4
C 9132	CHIP CAP.	33pF	50V	CH	GRM1882C1H330JA01D	K22174223		1-	A	D3
C 9134	CHIP CAP.	0.01uF	50V	B	GRM188B11H103KA01D	K22174823		1-	A	D2
C 9135	CHIP CAP.	0.001uF	50V	B	GRM188B11H102KA01D	K22174821		1-	A	D2
C 9136	CHIP TA.CAP.	0.22uF	35V		TEESVA1V224M8R	K78160027		1-	A	D2
D 9001	LED				SML-310VTT86JK	G2071032		1-	A	E1
D 9002	LED				SML-310VTT86JK	G2071032		1-	A	E1
FB9001	FERRITE BEADS				BLM18RK221SN1D	L9190175		1-	A	G3
FB9002	FERRITE BEADS				BLM18RK221SN1D	L9190175		1-	A	G3
FB9003	FERRITE BEADS				BLM18RK221SN1D	L9190175		1-	A	G3
FB9005	FERRITE BEADS				BLM18RK221SN1D	L9190175		1-	A	G3
FB9006	FERRITE BEADS				BK2125HS101-T	L9190087		1-	A	G3
FB9007	FERRITE BEADS				BLM18RK221SN1D	L9190175		1-	A	G3
FB9008	FERRITE BEADS				BLM18RK221SN1D	L9190175		1-	A	G3
FB9009	FERRITE BEADS				BLM18RK221SN1D	L9190175		1-	A	G3
FB9010	FERRITE BEADS				BLM18RK221SN1D	L9190175		1-	B	d3

DSP2 Unit (Lot.43~)

Parts List

REF	DESCRIPTION	VALUE	V/W	TOL.	MFR'S DESIG	VXSTD P/N	VERS.	LOT	SIDE	LAY ADR
J 9001	CONNECTOR				SB20-08WL	P0090847		1-	A	A2
J 9002	CONNECTOR				18FLT-SM2-TB(LF)(SN)(M)	P1091176		1-	A	G3
JP9001	WIRE AWG40-0.21PFA				GRN 65(2)/(2)	T9318336		43-46		
L 9001	CHIP COIL	100uH			CDRH5D28NP-101NC	L1691511		1-	A	B4
L 9002	CHIP COIL	100uH			CDRH5D28NP-101NC	L1691511		1-	A	B3
L 9003	CHIP COIL	100uH			CDRH5D28NP-101NC	L1691511		1-	A	C2
L 9004	CHIP COIL	100uH			CDRH5D28NP-101NC	L1691511		1-	A	C2
L 9005	CHIP COIL	3uH			CDRH5D28NP-3R0NC	L1691509		1-	A	D2
L 9006	CHIP COIL	3uH			CDRH5D28NP-3R0NC	L1691509		1-	A	D3
Q 9001	IC				NJM2068V-TE1	G1094112		1-	A	B1
Q 9002	IC				NJM2068V-TE1	G1094112		1-	A	B2
Q 9003	IC				NJM2068V-TE1	G1094112		1-	A	B2
Q 9004	IC				NJM2068V-TE1	G1094112		1-	A	B3
Q 9005	IC				NJM2068V-TE1	G1094112		1-	A	C1
Q 9006	IC				NJM78L05UA-TE1	G1091325		1-	A	C3
Q 9007	IC				CS4270-CZZ	G1094482		1-	A	C2
Q 9008	IC				EPM3064ATC100-7N			1-	A	D2
Q 9009	IC				TPS62420DRCT	G1094479		1-	A	C3
Q 9010	IC				TPS3103K33DBVR	G1094480		1-	A	D2
Q 9011	IC				LTC2621CDD#TRPBF	G1094208		1-	A	C1
Q 9012	IC				TMS320C6720BRFP200	G1094478		1-	A	E3
Q 9013	IC				A29L400ATV-70F(AH031H)	G1094797		1-	A	F3
Q 9013	IC				A29L400ATV-70F R1683	G1094834		47-	A	F3
R 9001	CHIP RES.	0	1/16W	5%	RMC1/16 000JATP	J24185000		1-	A	C2
R 9002	CHIP RES.	0	1/16W	5%	RMC1/16 000JATP	J24185000		1-	A	A1
R 9003	CHIP RES.	1k	1/16W	1%	RMC1/16 102FTP	J24183102		1-	A	A2
R 9004	CHIP RES.	15k	1/16W	1%	RMC1/16 153FTP	J24183153		1-	A	B2
R 9005	CHIP RES.	10k	1/16W	1%	RMC1/16 103FTP	J24183103		1-	A	B1
R 9006	CHIP RES.	1k	1/16W	1%	RMC1/16 102FTP	J24183102		1-	A	B1
R 9007	CHIP RES.	15k	1/16W	1%	RMC1/16 153FTP	J24183153		1-	A	B1
R 9008	CHIP RES.	10k	1/16W	1%	RMC1/16 103FTP	J24183103		1-	A	B1
R 9009	CHIP RES.	47k	1/16W	1%	RMC1/16 473FTP	J24183473		1-	A	A2
R 9010	CHIP RES.	100	1/16W	5%	RMC1/16 101JATP	J24185101		1-	A	A2
R 9011	CHIP RES.	1k	1/16W	1%	RMC1/16 102FTP	J24183102		1-	A	A2
R 9012	CHIP RES.	47k	1/16W	1%	RMC1/16 473FTP	J24183473		1-	A	A3
R 9013	CHIP RES.	0	1/16W	5%	RMC1/16 000JATP	J24185000		1-	A	A3
R 9014	CHIP RES.	0	1/16W	5%	RMC1/16 000JATP	J24185000		1-	A	A2
R 9015	CHIP RES.	0	1/16W	5%	RMC1/16 000JATP	J24185000		1-	A	C1
R 9016	CHIP RES.	0	1/16W	5%	RMC1/16 000JATP	J24185000		1-	A	A4
R 9017	CHIP RES.	10k	1/16W	1%	RMC1/16 103FTP	J24183103		1-	A	B1
R 9018	CHIP RES.	10k	1/16W	1%	RMC1/16 103FTP	J24183103		1-	A	B1
R 9019	CHIP RES.	10k	1/16W	1%	RMC1/16 103FTP	J24183103		1-	A	A1
R 9020	CHIP RES.	10k	1/16W	1%	RMC1/16 103FTP	J24183103		1-	A	B1
R 9021	CHIP RES.	10k	1/16W	1%	RMC1/16 103FTP	J24183103		1-	A	B2
R 9022	CHIP RES.	10k	1/16W	1%	RMC1/16 103FTP	J24183103		1-	A	B2
R 9023	CHIP RES.	10k	1/16W	1%	RMC1/16 103FTP	J24183103		1-	A	B2
R 9024	CHIP RES.	10k	1/16W	1%	RMC1/16 103FTP	J24183103		1-	A	B2
R 9025	CHIP RES.	10k	1/16W	1%	RMC1/16 103FTP	J24183103		1-	A	B2
R 9026	CHIP RES.	3.3k	1/16W	1%	RMC1/16 332FTP	J24183332		1-	A	B2
R 9027	CHIP RES.	10k	1/16W	1%	RMC1/16 103FTP	J24183103		1-	A	B2
R 9028	CHIP RES.	10k	1/16W	1%	RMC1/16 103FTP	J24183103		1-	A	B2
R 9029	CHIP RES.	10k	1/16W	1%	RMC1/16 103FTP	J24183103		1-	A	B3
R 9030	CHIP RES.	10k	1/16W	1%	RMC1/16 103FTP	J24183103		1-	A	B3
R 9032	CHIP RES.	0	1/16W	5%	RMC1/16 000JATP	J24185000		1-	A	G3
R 9034	CHIP RES.	0	1/16W	5%	RMC1/16 000JATP	J24185000		1-	A	F3
R 9035	CHIP RES.	0	1/16W	5%	RMC1/16 000JATP	J24185000		1-	A	A1
R 9036	CHIP RES.	0	1/16W	5%	RMC1/16 000JATP	J24185000		1-	A	A4
R 9037	CHIP RES.	1k	1/16W	5%	RMC1/16 102JATP	J24185102		1-	A	B1
R 9038	CHIP RES.	1k	1/16W	5%	RMC1/16 102JATP	J24185102		1-	A	C2
R 9039	CHIP RES.	10k	1/16W	1%	RMC1/16 103FTP	J24183103		1-	A	B2
R 9040	CHIP RES.	10k	1/16W	1%	RMC1/16 103FTP	J24183103		1-	A	B3
R 9041	CHIP RES.	47k	1/16W	1%	RMC1/16 473FTP	J24183473		1-	A	C1
R 9042	CHIP RES.	1k	1/16W	1%	RMC1/16 102FTP	J24183102		1-	A	C1
R 9043	CHIP RES.	33	1/16W	5%	RMC1/16 330JATP	J24185330		1-	A	D2
R 9046	CHIP RES.	2.2k	1/16W	5%	RMC1/16 222JATP	J24185222		1-	A	C1
R 9047	CHIP RES.	2.2k	1/16W	5%	RMC1/16 222JATP	J24185222		1-	A	C2
R 9048	CHIP RES.	2.2k	1/16W	5%	RMC1/16 222JATP	J24185222		1-	A	C2
R 9049	CHIP RES.	47k	1/16W	5%	RMC1/16 473JATP	J24185473		1-	A	C2
R 9050	CHIP RES.	1.5k	1/16W	1%	RMC1/16 152FTP	J24183152		1-	A	C1
R 9051	CHIP RES.	7.5k	1/16W	1%	RMC1/16 752FTP	J24183752		1-	A	C1
R 9052	CHIP RES.	0	1/16W	5%	RMC1/16 000JATP	J24185000		1-	A	C1
R 9053	CHIP RES.	10k	1/16W	1%	RMC1/16 103FTP	J24183103		1-	A	C1
R 9054	CHIP RES.	47k	1/16W	5%	RMC1/16 473JATP	J24185473		1-	A	C3

DSP2 Unit (Lot.43~)

Parts List

REF	DESCRIPTION	VALUE	V/W	TOL.	MFR'S DESIG	VXSTD P/N	VERS.	LOT	SIDE	LAY ADR
R 9055	CHIP RES.	47k	1/16W	5%	RMC1/16 473JATP	J24185473		1-	A	C2
R 9056	CHIP RES.	47k	1/16W	5%	RMC1/16 473JATP	J24185473		1-	A	C2
R 9057	CHIP RES.	150k	1/16W	1%	RMC1/16 154FTP	J24183154		1-	A	C3
R 9058	CHIP RES.	220k	1/16W	1%	RMC1/16 224FTP	J24183224		1-	A	D3
R 9059	CHIP RES.	1k	1/16W	5%	RMC1/16 102JATP	J24185102		1-	A	C2
R 9060	CHIP RES.	220k	1/16W	1%	RMC1/16 224FTP	J24183224		1-	A	D3
R 9061	CHIP RES.	680k	1/16W	1%	RMC1/16 684FTP	J24183684		1-	A	C3
R 9062	CHIP RES.	150k	1/16W	1%	RMC1/16 154FTP	J24183154		1-	A	D2
R 9063	CHIP RES.	10k	1/16W	1%	RMC1/16 103FTP	J24183103		1-	A	D2
R 9064	CHIP RES.	150k	1/16W	1%	RMC1/16 154FTP	J24183154		1-	A	D2
R 9065	CHIP RES.	2.2k	1/16W	5%	RMC1/16 222JATP	J24185222		1-	A	E1
R 9066	CHIP RES.	2.2k	1/16W	5%	RMC1/16 222JATP	J24185222		1-	A	E1
R 9067	CHIP RES.	2.2k	1/16W	5%	RMC1/16 222JATP	J24185222		1-	A	F2
R 9069	CHIP RES.	2.2k	1/16W	5%	RMC1/16 222JATP	J24185222		1-	A	E2
R 9070	CHIP RES.	2.2k	1/16W	5%	RMC1/16 222JATP	J24185222		1-	A	F1
R 9071	CHIP RES.	2.2k	1/16W	5%	RMC1/16 222JATP	J24185222		1-	A	F2
R 9073	CHIP RES.	2.2k	1/16W	5%	RMC1/16 222JATP	J24185222		1-	A	E1
R 9074	CHIP RES.	2.2k	1/16W	5%	RMC1/16 222JATP	J24185222		1-	A	E1
R 9075	CHIP RES.	2.2k	1/16W	5%	RMC1/16 222JATP	J24185222		1-	A	E1
R 9076	CHIP RES.	2.2k	1/16W	5%	RMC1/16 222JATP	J24185222		1-	A	E1
R 9077	CHIP RES.	2.2k	1/16W	5%	RMC1/16 222JATP	J24185222		1-	B	b3
R 9078	CHIP RES.	2.2k	1/16W	5%	RMC1/16 222JATP	J24185222		1-	A	F2
R 9079	CHIP RES.	2.2k	1/16W	5%	RMC1/16 222JATP	J24185222		1-	A	F2
R 9080	CHIP RES.	2.2k	1/16W	5%	RMC1/16 222JATP	J24185222		1-	A	F2
R 9081	CHIP RES.	2.2k	1/16W	5%	RMC1/16 222JATP	J24185222		1-	A	F3
R 9082	CHIP RES.	2.2k	1/16W	5%	RMC1/16 222JATP	J24185222		1-	A	F2
R 9083	CHIP RES.	2.2k	1/16W	5%	RMC1/16 222JATP	J24185222		1-	A	E2
R 9084	CHIP RES.	2.2k	1/16W	5%	RMC1/16 222JATP	J24185222		1-	A	F2
R 9086	CHIP RES.	10k	1/16W	5%	RMC1/16 103JATP	J24185103		1-	A	G3
R 9087	CHIP RES.	2.2	1/4W	5%	RMC1/4 2R2JATP	J24245229		1-	A	C4
R 9088	CHIP RES.	3.3M	1/16W	5%	RMC1/16 335JATP	J24185335		1-	A	D3
R 9089	CHIP RES.	20k	1/16W	1%	RMC1/16 203FTP	J24183203		1-	A	C3
R 9090	CHIP RES.	0	1/16W	5%	RMC1/16 000JATP	J24185000		1-	A	C2
R 9091	CHIP RES.	2.2k	1/16W	5%	RMC1/16 222JATP	J24185222		1-	A	F2
R 9092	CHIP RES.	0	1/16W	5%	RMC1/16 000JATP	J24185000		44-		
R 9093	CHIP RES.	3.3k	1/16W	5%	RMC1/16 332JATP	J24185332		43-46		
X 9001	XTAL OSC	18.432MHz			TPS18XC-E1 18.432MHZ	H9501010		1-	A	D2
	CAPTAN TAPE				(5X10)	RA1209400		43-46		

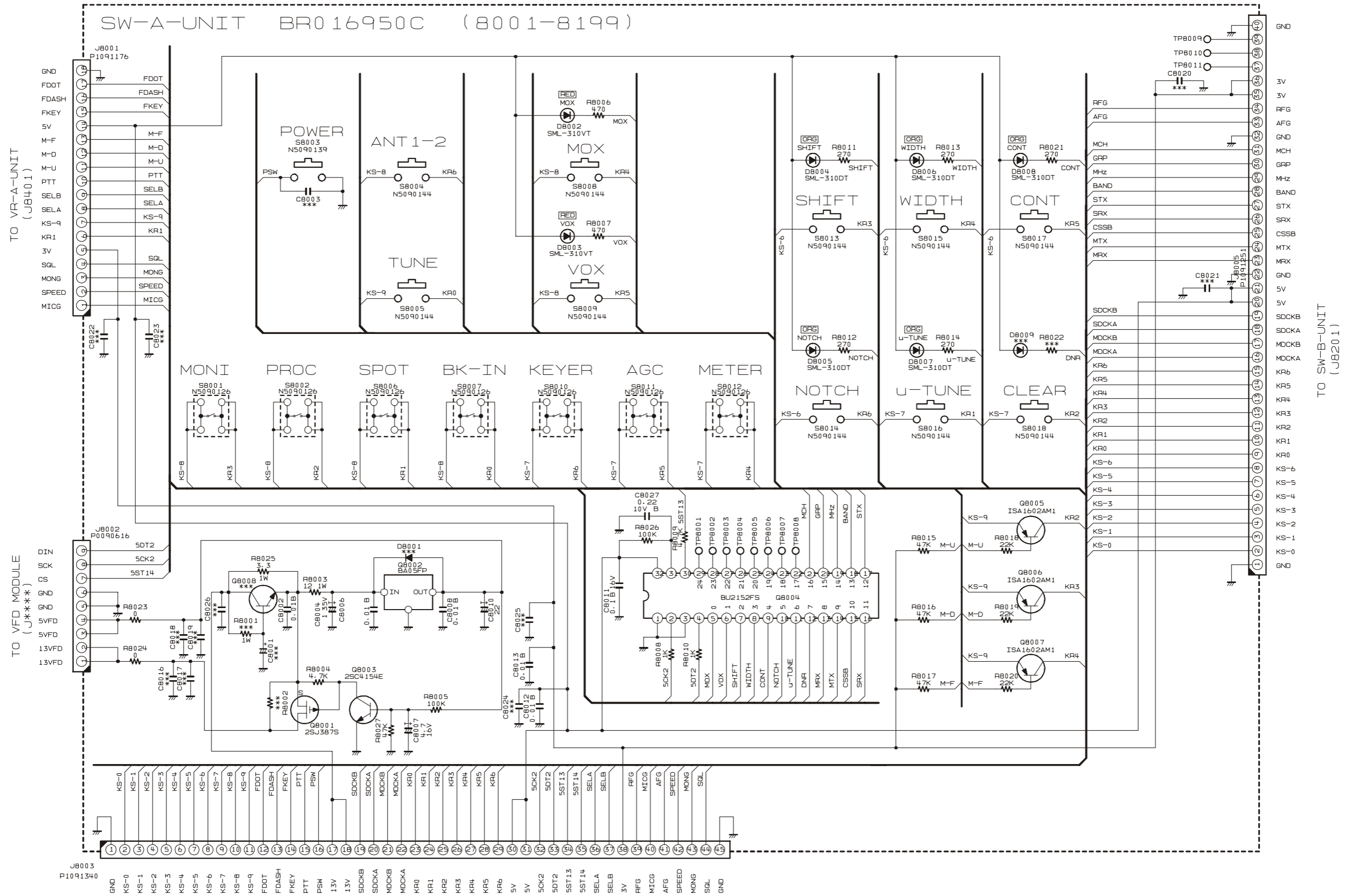

SW-A Unit

Note

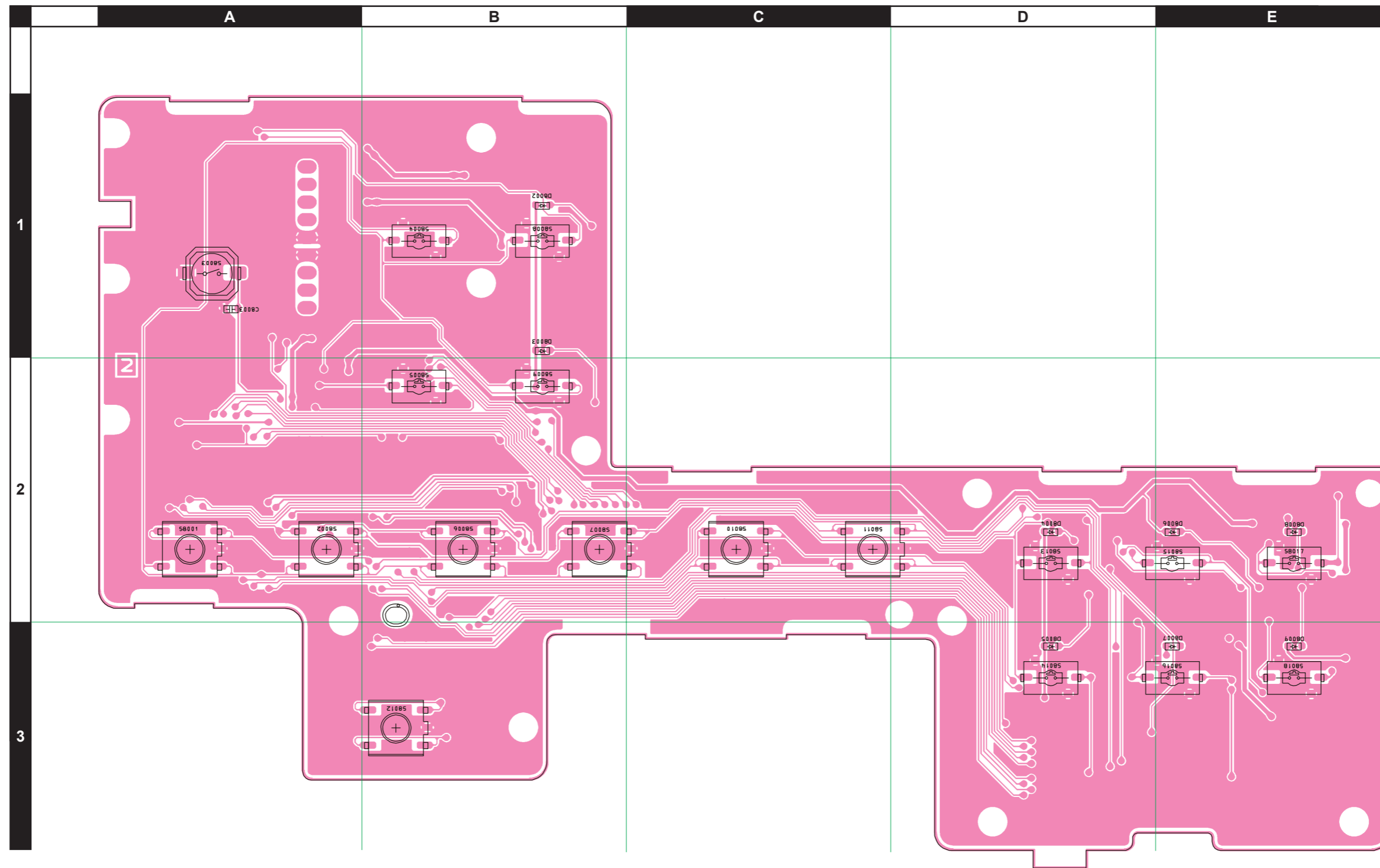

SW-A Unit

Parts List

REF	DESCRIPTION	VALUE	V/W	TOL.	MFR'S DESIG	VXSTD P/N	VERS.	LOT	SIDE	LAY ADR
PCB with Components						CB4036001				
Printed Circuit Board						FR016950C		1-		
C 8002	CHIP CAP.	0.01uF	50V	B	GRM188B11H103KA01D	K22174823		1-	B	d1
C 8004	CHIP TA.CAP.	1uF	35V		TEESVA1V105M8R	K78160032		1-	B	d2
C 8006	CHIP CAP.	0.01uF	50V	B	GRM188B11H103KA01D	K22174823		1-	B	d2
C 8007	CHIP TA.CAP.	4.7uF	16V		TEESVA1C475M8R	K78120031		1-	B	d1
C 8008	CHIP CAP.	0.01uF	50V	B	GRM188B11H103KA01D	K22174823		1-	B	d1
C 8010	CHIP TA.CAP.	22uF			TPSB226M016Y0600	K78120075		1-	B	d1
C 8011	CHIP CAP.	0.1uF	16V	B	GRM188B11C104KA01D	K22124805		1-	B	a2
C 8012	CHIP CAP.	0.01uF	50V	B	GRM188B11H103KA01D	K22174823		1-	B	d2
C 8013	CHIP CAP.	0.01uF	50V	B	GRM188B11H103KA01D	K22174823		1-	B	d2
C 8027	CHIP CAP.	0.22uF	10V	B	GRM188B11A224KA01D	K22104801		1-	B	a2
D 8002	LED				SML-310VTT86JK	G2071032		1-	A	B1
D 8003	LED				SML-310VTT86JK	G2071032		1-	A	B1
D 8004	LED				SML-310DTT86KL	G2071024		1-	A	D2
D 8005	LED				SML-310DTT86KL	G2071024		1-	A	D3
D 8006	LED				SML-310DTT86KL	G2071024		1-	A	E2
D 8007	LED				SML-310DTT86KL	G2071024		1-	A	E3
D 8008	LED				SML-310DTT86KL	G2071024		1-	A	E2
J 8001	CONNECTOR				18FLT-SM2-TB(LF)(SN)(M)	P1091176		1-	B	a3
J 8002	CONNECTOR				SB20-09WS	P0090616		1-	B	e1
J 8003	CONNECTOR				IMSA-9639S-45	P1091340		1-	B	e2
J 8005	CONNECTOR				40FLT-SM2-TB(LF)(SN)(M)	P1091251		1-	B	a3
Q 8001	FET				2SJ387STL	G3703878		1-	B	d1
Q 8002	IC				BA05FP-E2	G1093209		1-	B	d1
Q 8003	TRANSISTOR				2SC4154-T111-1E	G3341548E		1-	B	d1
Q 8003	TRANSISTOR				2SC4081 T106	G3340818		9-	B	d1
Q 8004	IC				BU2152FS(TAPE)	G1093942		1-	B	a2
Q 8005	TRANSISTOR				ISA1602AM1-T111-1F	G3070380		1-	B	e1
Q 8005	TRANSISTOR				2SA1576A T106 R	G3115768R		9-	B	e1
Q 8006	TRANSISTOR				ISA1602AM1-T111-1F	G3070380		1-	B	e2
Q 8006	TRANSISTOR				2SA1576A T106 R	G3115768R		9-	B	e2
Q 8007	TRANSISTOR				ISA1602AM1-T111-1F	G3070380		1-	B	e2
Q 8007	TRANSISTOR				2SA1576A T106 R	G3115768R		9-	B	e2
R 8003	CHIP RES.	12	1W	5%	RMC1 120JTE	J24305120		1-	B	d1
R 8004	CHIP RES.	4.7k	1/16W	5%	RMC1/16 472JATP	J24185472		1-	B	d1
R 8005	CHIP RES.	100k	1/16W	5%	RMC1/16 104JATP	J24185104		1-	B	d1
R 8006	CHIP RES.	470	1/16W	5%	RMC1/16 471JATP	J24185471		1-	B	d1
R 8007	CHIP RES.	470	1/16W	5%	RMC1/16 471JATP	J24185471		1-	B	d2
R 8008	CHIP RES.	1k	1/16W	5%	RMC1/16 102JATP	J24185102		1-	B	b2
R 8009	CHIP RES.	4.7k	1/16W	5%	RMC1/16 472JATP	J24185472		1-	B	b2
R 8010	CHIP RES.	1k	1/16W	5%	RMC1/16 102JATP	J24185102		1-	B	b2
R 8011	CHIP RES.	270	1/16W	5%	RMC1/16 271JATP	J24185271		1-	B	a2
R 8012	CHIP RES.	270	1/16W	5%	RMC1/16 271JATP	J24185271		1-	B	b2
R 8013	CHIP RES.	270	1/16W	5%	RMC1/16 271JATP	J24185271		1-	B	a2
R 8014	CHIP RES.	270	1/16W	5%	RMC1/16 271JATP	J24185271		1-	B	b2
R 8015	CHIP RES.	47k	1/16W	5%	RMC1/16 473JATP	J24185473		1-	B	e2
R 8016	CHIP RES.	47k	1/16W	5%	RMC1/16 473JATP	J24185473		1-	B	e2
R 8017	CHIP RES.	47k	1/16W	5%	RMC1/16 473JATP	J24185473		1-	B	e2
R 8018	CHIP RES.	22k	1/16W	5%	RMC1/16 223JATP	J24185223		1-	B	e2
R 8019	CHIP RES.	22k	1/16W	5%	RMC1/16 223JATP	J24185223		1-	B	e2
R 8020	CHIP RES.	22k	1/16W	5%	RMC1/16 223JATP	J24185223		1-	B	e2
R 8021	CHIP RES.	270	1/16W	5%	RMC1/16 271JATP	J24185271		1-	B	a2
R 8023	CHIP RES.	0	1/16W	5%	RMC1/16 000JATP	J24185000		1-	B	d1
R 8024	CHIP RES.	0	1/16W	5%	RMC1/16 000JATP	J24185000		1-	B	d1
R 8025	CHIP RES.	3.3	1W	5%	RMC1 3R3JTE	J24305339		1-	B	d1
R 8026	CHIP RES.	100k	1/16W	5%	RMC1/16 104JATP	J24185104		1-	B	a2
R 8027	CHIP RES.	47k	1/16W	5%	RMC1/16 473JATP	J24185473		1-	B	d1
S 8001	TACT SWITCH				SKHUPLE010	N5090126		1-	A	A2
S 8002	TACT SWITCH				SKHUPLE010	N5090126		1-	A	A2
S 8003	TACT SWITCH				SKPMAPE010	N5090139		1-	A	A1
S 8004	TACT SWITCH				SKQYPAE010	N5090144		1-	A	B1
S 8005	TACT SWITCH				SKQYPAE010	N5090144		1-	A	B2
S 8006	TACT SWITCH				SKHUPLE010	N5090126		1-	A	B2
S 8007	TACT SWITCH				SKHUPLE010	N5090126		1-	A	B2
S 8008	TACT SWITCH				SKQYPAE010	N5090144		1-	A	B1
S 8009	TACT SWITCH				SKQYPAE010	N5090144		1-	A	B2
S 8010	TACT SWITCH				SKHUPLE010	N5090126		1-	A	C2
S 8011	TACT SWITCH				SKHUPLE010	N5090126		1-	A	C2
S 8012	TACT SWITCH				SKHUPLE010	N5090126		1-	A	B3
S 8013	TACT SWITCH				SKQYPAE010	N5090144		1-	A	D2
S 8014	TACT SWITCH				SKQYPAE010	N5090144		1-	A	D3
S 8015	TACT SWITCH				SKQYPAE010	N5090144		1-	A	E2

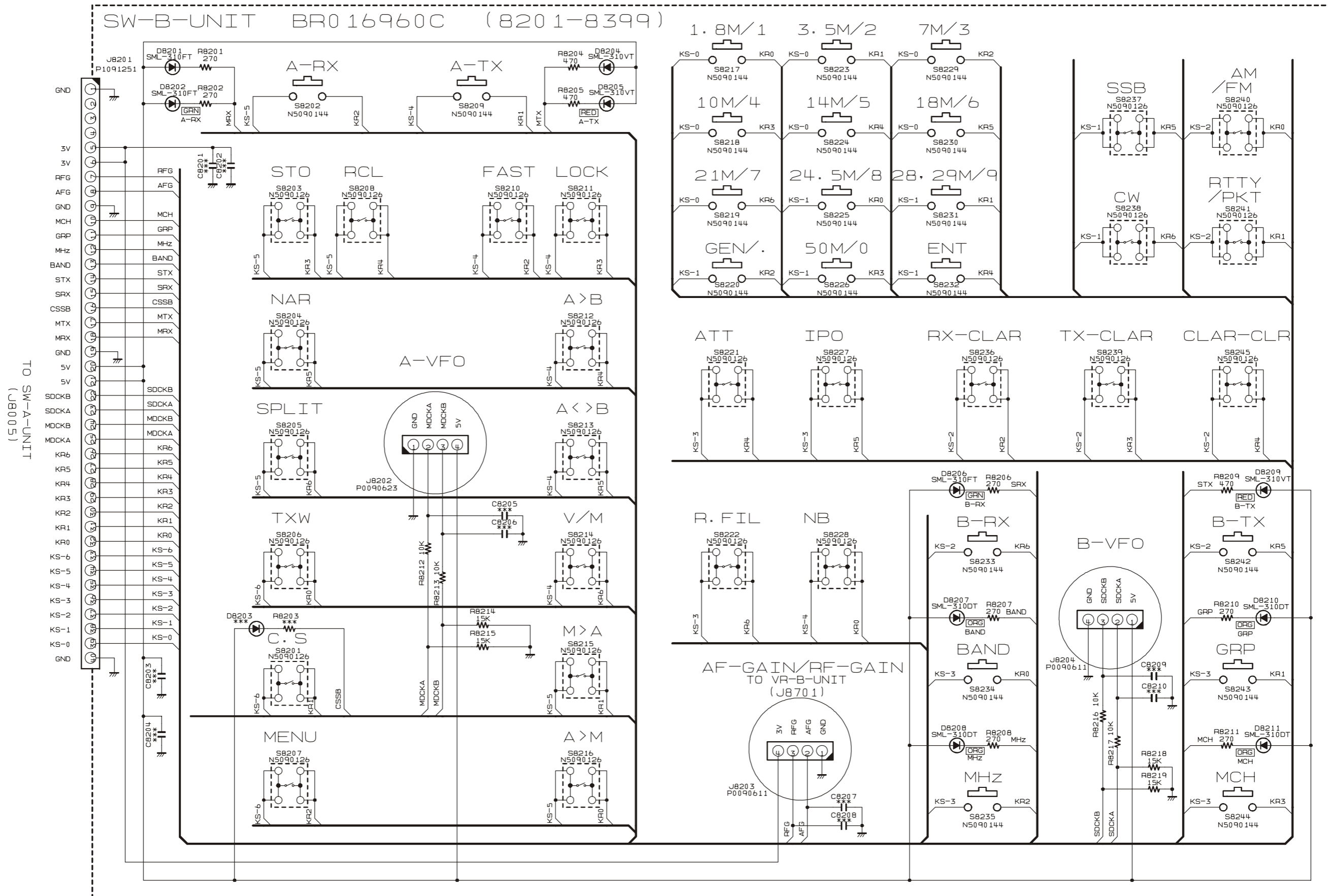

SW-B Unit

Note

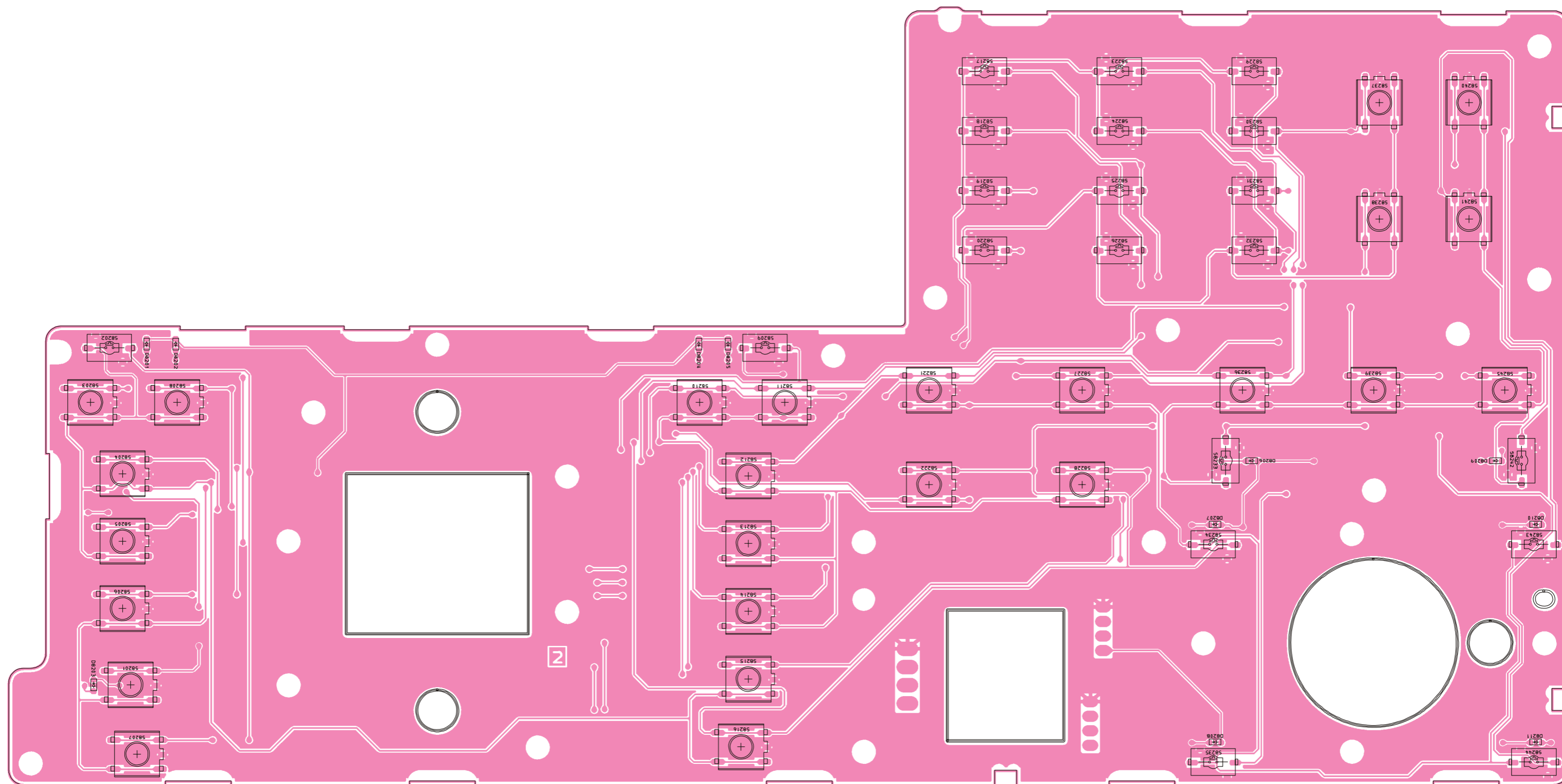

SW-B Unit

Parts Layout (Side B)

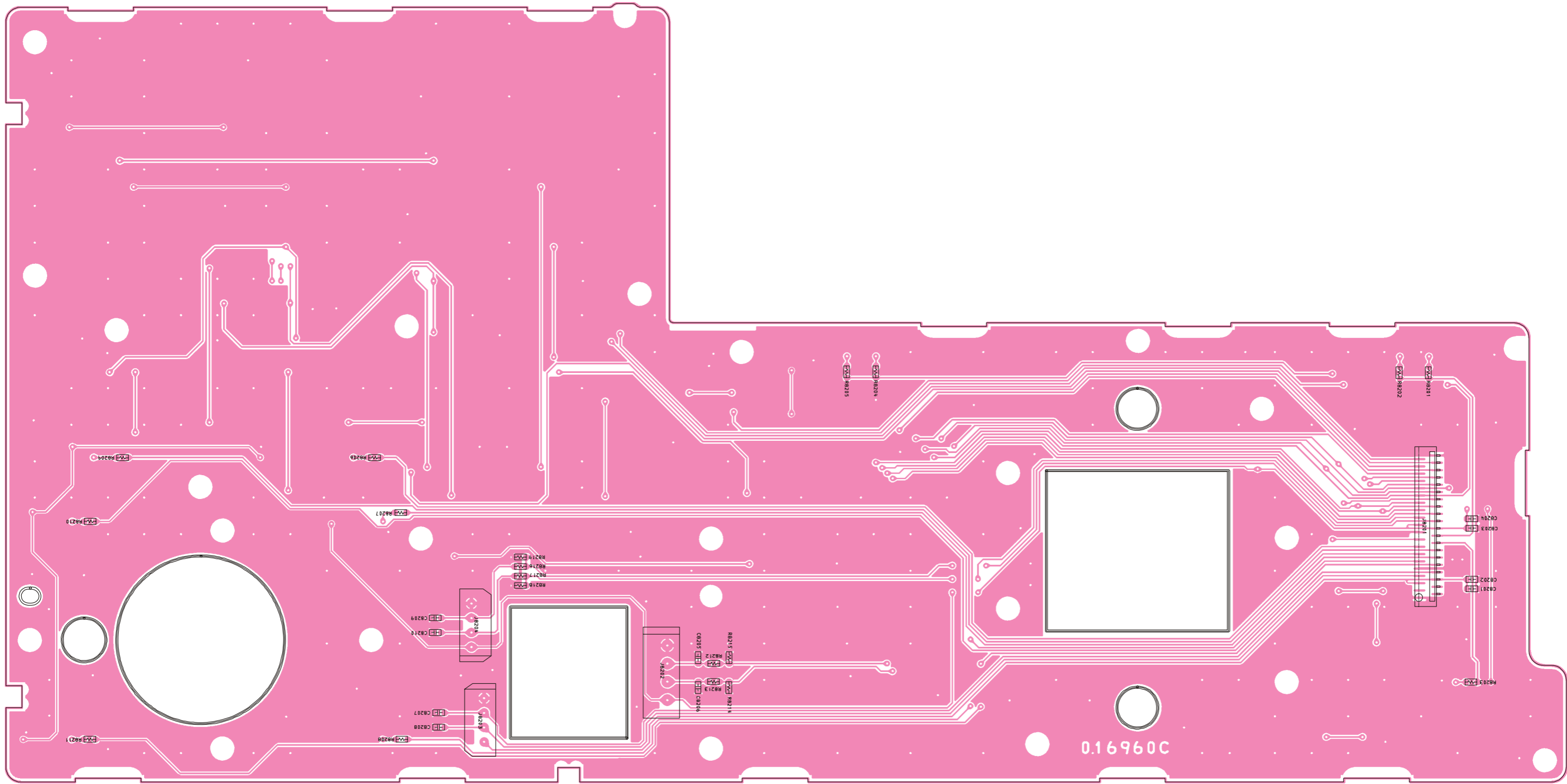

SW-B Unit

Parts List

REF	DESCRIPTION	VALUE	V/W	TOL.	MFR'S DESIG	VXSTD P/N	VERS.	LOT	SIDE	LAY ADR
PCB with Components						CB4037001				
Printed Circuit Board						FR016960C		1-		
D 8201	LED				SML-310FTT86KL	G2071026		1-	A	A2
D 8202	LED				SML-310FTT86KL	G2071026		1-	A	A2
D 8204	LED				SML-310VTT86JK	G2071032		1-	A	D2
D 8205	LED				SML-310VTT86JK	G2071032		1-	A	D2
D 8206	LED				SML-310FTT86KL	G2071026		1-	A	F3
D 8207	LED				SML-310DTT86KL	G2071024		1-	A	F3
D 8208	LED				SML-310DTT86KL	G2071024		1-	A	F4
D 8209	LED				SML-310VTT86JK	G2071032		1-	A	G3
D 8210	LED				SML-310DTT86KL	G2071024		1-	A	G3
D 8211	LED				SML-310DTT86KL	G2071024		1-	A	G4
J 8201	CONNECTOR				40FLT-SM2-TB(LF)(SN)	P1091251		1-	B	g3
J 8202	CONNECTOR				SC25-04WS	P0090623		1-	B	d3
J 8203	CONNECTOR				SB20-04WS	P0090611		1-	B	c4
J 8204	CONNECTOR				SB20-04WS	P0090611		1-	B	c3
R 8201	CHIP RES.	270	1/16W	5%	RMC1/16 271JATP	J24185271		1-	B	g2
R 8202	CHIP RES.	270	1/16W	5%	RMC1/16 271JATP	J24185271		1-	B	g2
R 8204	CHIP RES.	470	1/16W	5%	RMC1/16 471JATP	J24185471		1-	B	d2
R 8205	CHIP RES.	470	1/16W	5%	RMC1/16 471JATP	J24185471		1-	B	d2
R 8206	CHIP RES.	270	1/16W	5%	RMC1/16 271JATP	J24185271		1-	B	b3
R 8207	CHIP RES.	270	1/16W	5%	RMC1/16 271JATP	J24185271		1-	B	b3
R 8208	CHIP RES.	270	1/16W	5%	RMC1/16 271JATP	J24185271		1-	B	b4
R 8209	CHIP RES.	470	1/16W	5%	RMC1/16 471JATP	J24185471		1-	B	a3
R 8210	CHIP RES.	270	1/16W	5%	RMC1/16 271JATP	J24185271		1-	B	a3
R 8211	CHIP RES.	270	1/16W	5%	RMC1/16 271JATP	J24185271		1-	B	a4
R 8212	CHIP RES.	10k	1/16W	5%	RMC1/16 103JATP	J24185103		1-	B	d4
R 8213	CHIP RES.	10k	1/16W	5%	RMC1/16 103JATP	J24185103		1-	B	d4
R 8214	CHIP RES.	15k	1/16W	5%	RMC1/16 153JATP	J24185153		1-	B	d4
R 8215	CHIP RES.	15k	1/16W	5%	RMC1/16 153JATP	J24185153		1-	B	d3
R 8216	CHIP RES.	10k	1/16W	5%	RMC1/16 103JATP	J24185103		1-	B	c3
R 8217	CHIP RES.	10k	1/16W	5%	RMC1/16 103JATP	J24185103		1-	B	c3
R 8218	CHIP RES.	15k	1/16W	5%	RMC1/16 153JATP	J24185153		1-	B	c3
R 8219	CHIP RES.	15k	1/16W	5%	RMC1/16 153JATP	J24185153		1-	B	c3
S 8201	TACT SWITCH				SKHUPDE010	N5090126		1-	A	A4
S 8202	TACT SWITCH				SKQYPAE010	N5090144		1-	A	A2
S 8203	TACT SWITCH				SKHUPDE010	N5090126		1-	A	A2
S 8204	TACT SWITCH				SKHUPDE010	N5090126		1-	A	A3
S 8205	TACT SWITCH				SKHUPDE010	N5090126		1-	A	A3
S 8206	TACT SWITCH				SKHUPDE010	N5090126		1-	A	A3
S 8207	TACT SWITCH				SKHUPDE010	N5090126		1-	A	A4
S 8208	TACT SWITCH				SKHUPDE010	N5090126		1-	A	A2
S 8209	TACT SWITCH				SKQYPAE010	N5090144		1-	A	D2
S 8210	TACT SWITCH				SKHUPDE010	N5090126		1-	A	D2
S 8211	TACT SWITCH				SKHUPDE010	N5090126		1-	A	D2
S 8212	TACT SWITCH				SKHUPDE010	N5090126		1-	A	D3
S 8213	TACT SWITCH				SKHUPDE010	N5090126		1-	A	D3
S 8214	TACT SWITCH				SKHUPDE010	N5090126		1-	A	D3
S 8215	TACT SWITCH				SKHUPDE010	N5090126		1-	A	D4
S 8216	TACT SWITCH				SKHUPDE010	N5090126		1-	A	D4
S 8217	TACT SWITCH				SKQYPAE010	N5090144		1-	A	E1
S 8218	TACT SWITCH				SKQYPAE010	N5090144		1-	A	E1
S 8219	TACT SWITCH				SKQYPAE010	N5090144		1-	A	E1
S 8220	TACT SWITCH				SKQYPAE010	N5090144		1-	A	E2
S 8221	TACT SWITCH				SKHUPDE010	N5090126		1-	A	E2
S 8222	TACT SWITCH				SKHUPDE010	N5090126		1-	A	E3
S 8223	TACT SWITCH				SKQYPAE010	N5090144		1-	A	F1
S 8224	TACT SWITCH				SKQYPAE010	N5090144		1-	A	F1
S 8225	TACT SWITCH				SKQYPAE010	N5090144		1-	A	F1
S 8226	TACT SWITCH				SKQYPAE010	N5090144		1-	A	F2
S 8227	TACT SWITCH				SKHUPDE010	N5090126		1-	A	E2
S 8228	TACT SWITCH				SKHUPDE010	N5090126		1-	A	E3
S 8229	TACT SWITCH				SKQYPAE010	N5090144		1-	A	F1
S 8230	TACT SWITCH				SKQYPAE010	N5090144		1-	A	F1
S 8231	TACT SWITCH				SKQYPAE010	N5090144		1-	A	F1
S 8232	TACT SWITCH				SKQYPAE010	N5090144		1-	A	F2
S 8233	TACT SWITCH				SKQYPAE010	N5090144		1-	A	F3
S 8234	TACT SWITCH				SKQYPAE010	N5090144		1-	A	F3
S 8235	TACT SWITCH				SKQYPAE010	N5090144		1-	A	F4
S 8236	TACT SWITCH				SKHUPDE010	N5090126		1-	A	F2
S 8237	TACT SWITCH				SKHUPDE010	N5090126		1-	A	G1
S 8238	TACT SWITCH				SKHUPDE010	N5090126		1-	A	G1
S 8239	TACT SWITCH				SKHUPDE010	N5090126		1-	A	G2

VR-A Unit

Circuit Diagram (Lot. 1~)

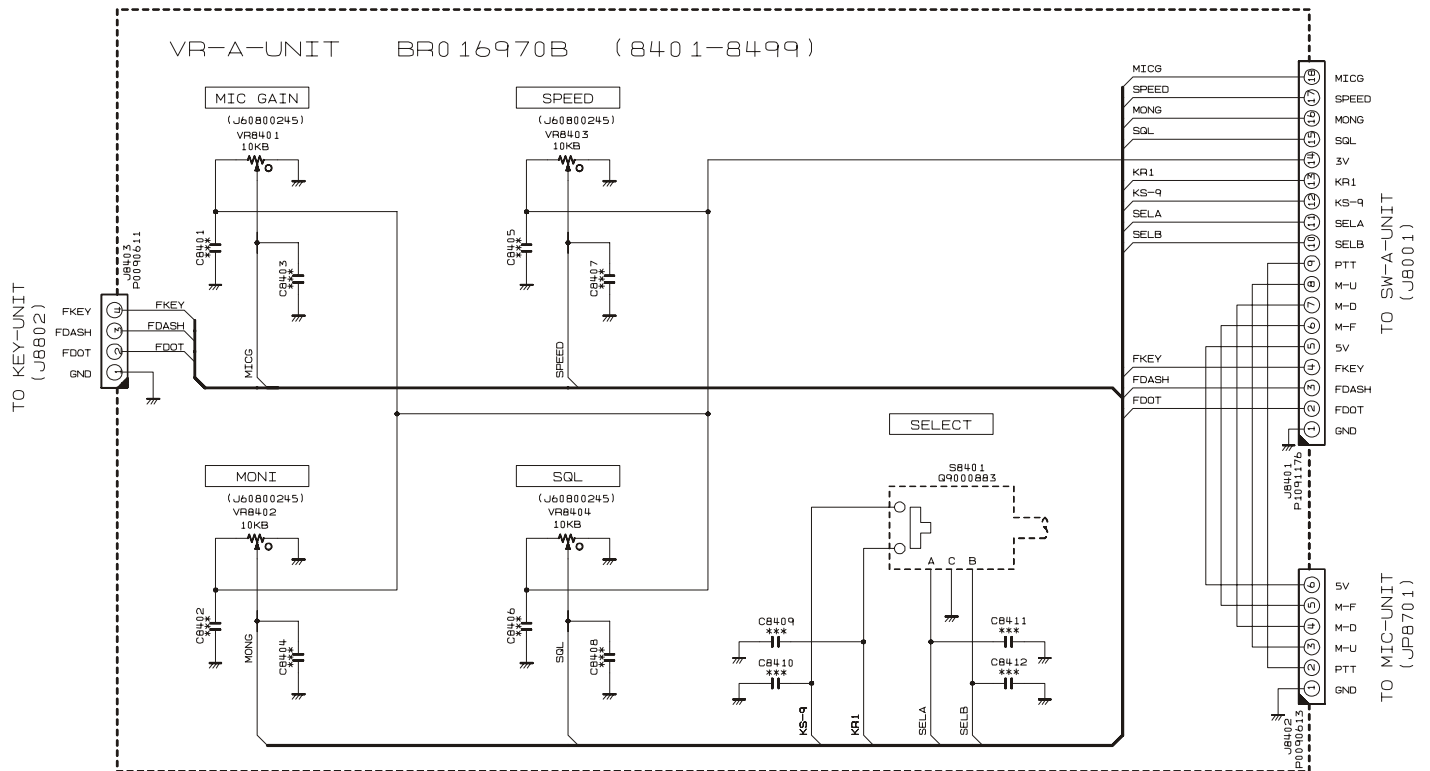

VR-A Unit

Parts Layout (Side A) (Lot. 1~)

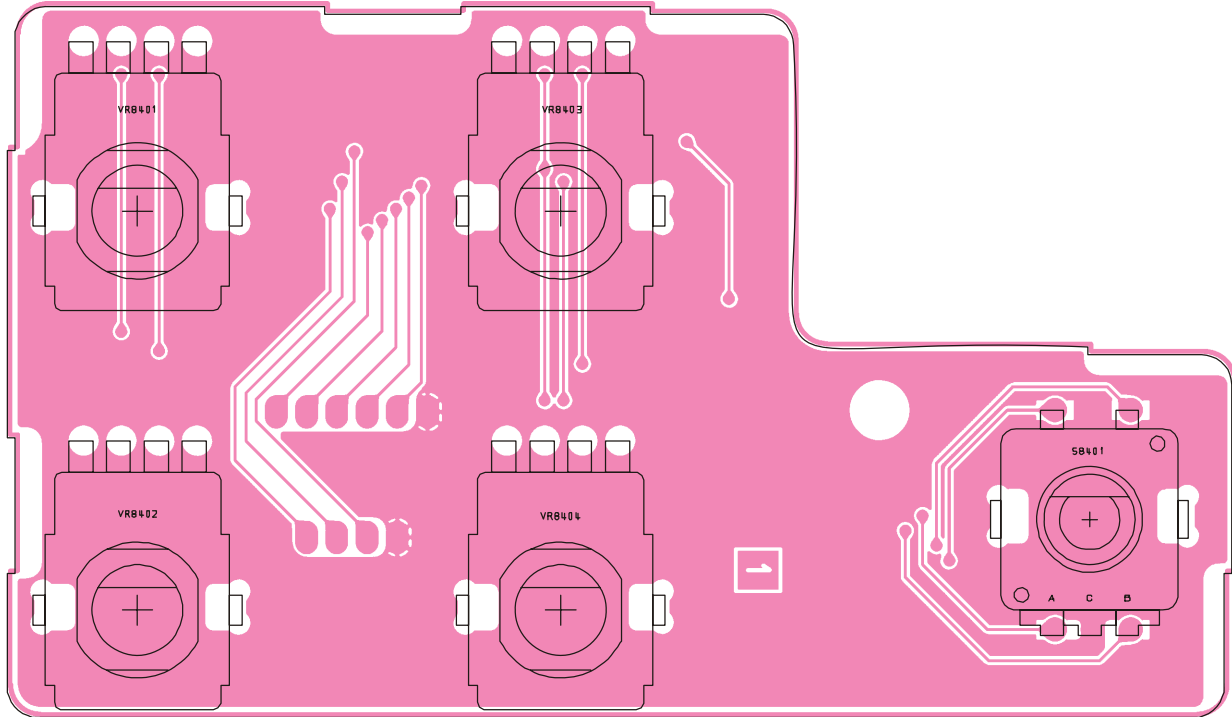

Parts Layout (Side B) (Lot. 1~)

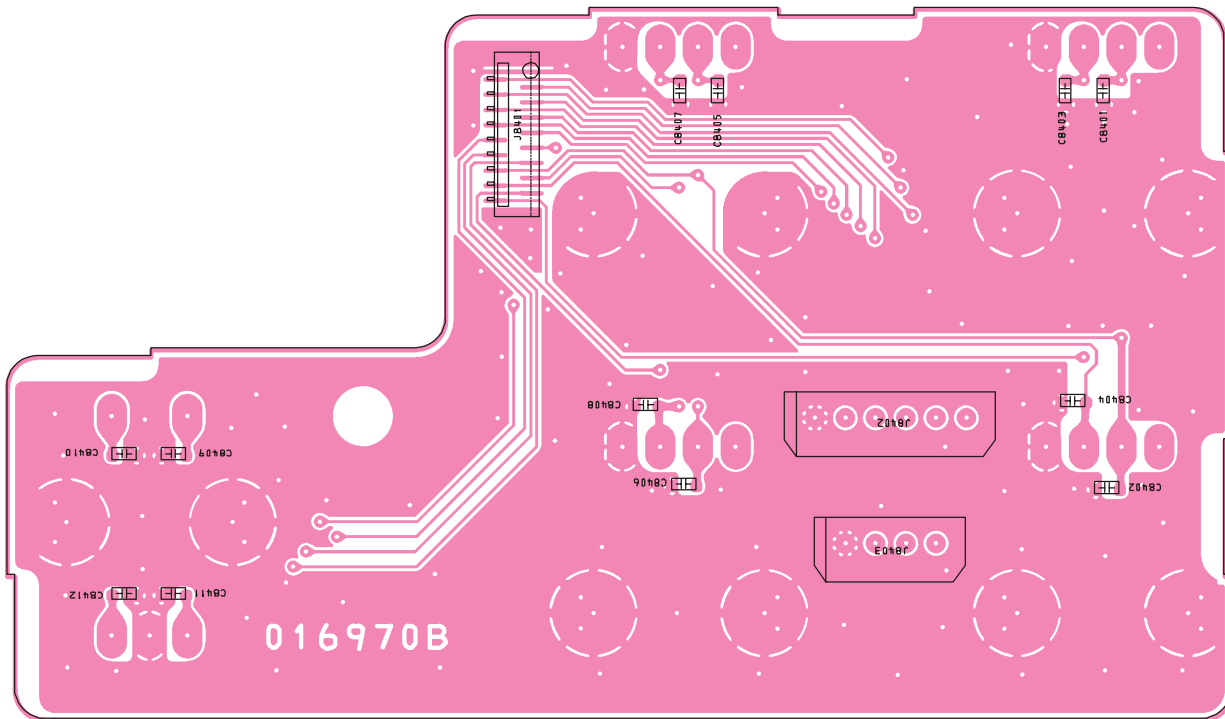

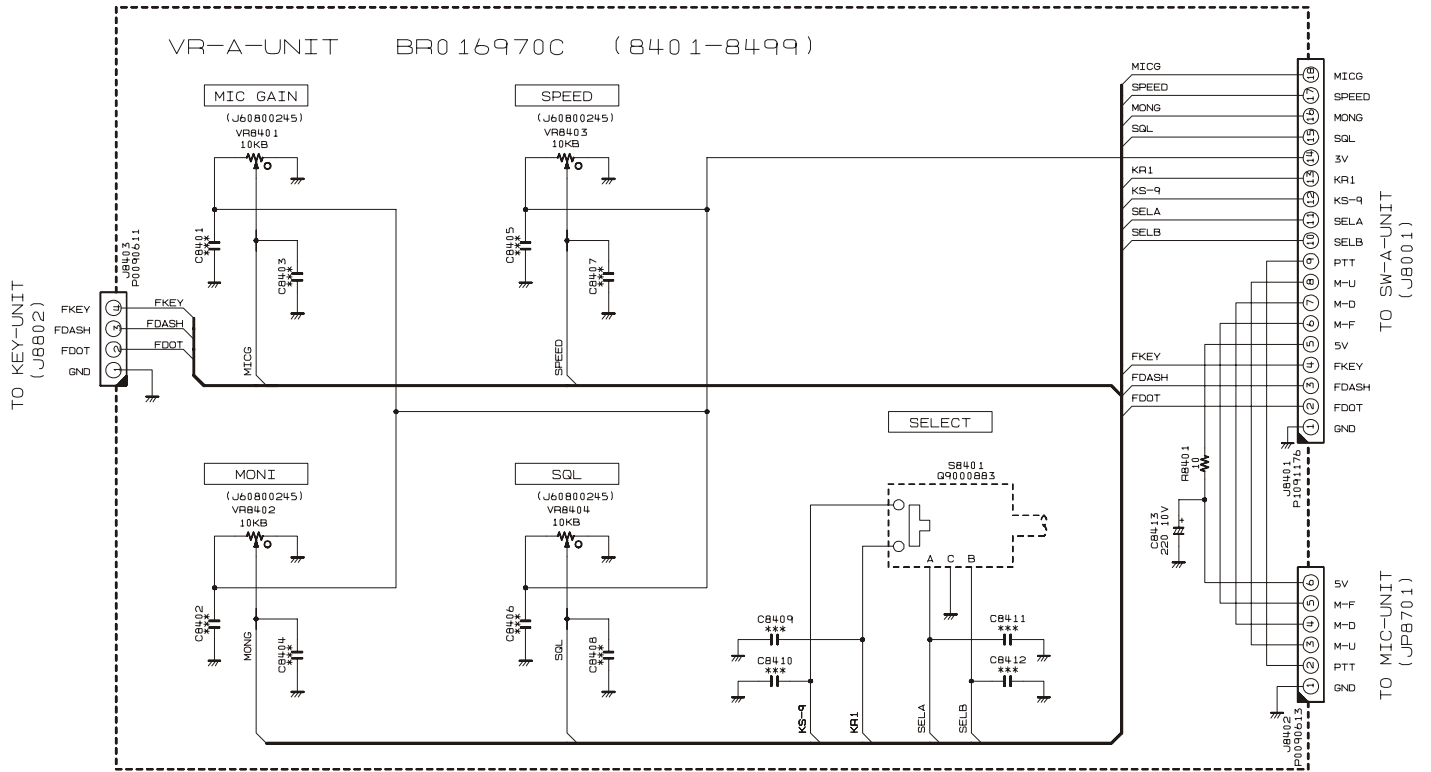

VR-A Unit

Parts Layout (Side A) (Lot. 8~)

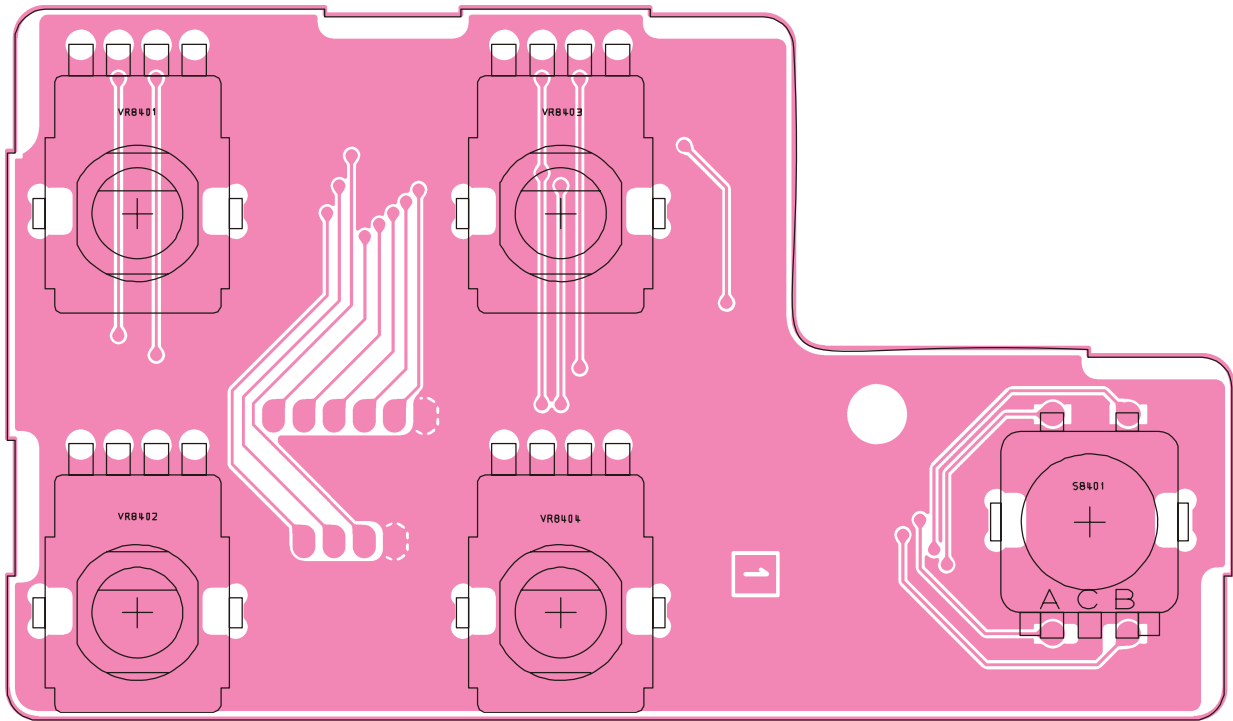

Parts Layout (Side B) (Lot. 8~)

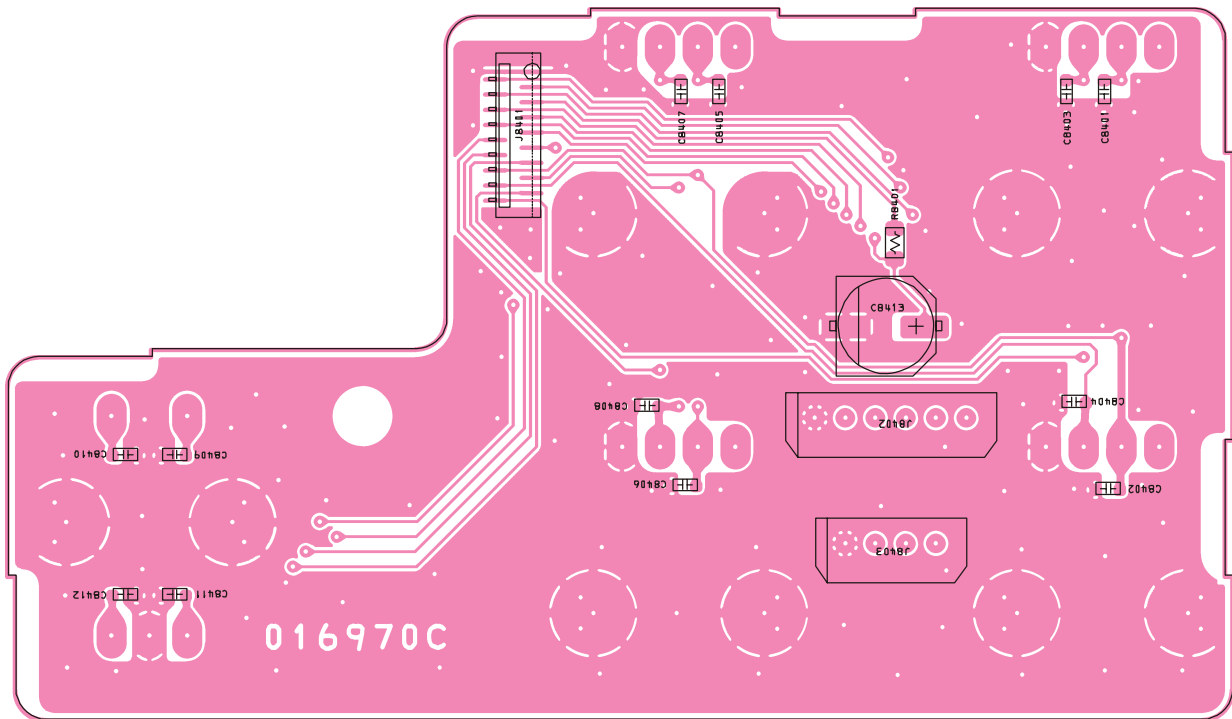

VR-A Unit

Parts List

REF	DESCRIPTION	VALUE	V/W	TOL.	MFR'S DESIG	VXSTD P/N	VERS.	LOT	SIDE	LAY ADR
	PCB with Components					CB4038001				
	Printed Circuit Board					FR016970B		1-		
	Printed Circuit Board					FR016970C		8-		
C 8413	AL.ELECTRO.CAP.	220uF	10V		RV3-10V221MF80-R	K48100002		8-	B	
J 8401	CONNECTOR				18FLT-SM2-TB(LF)(SN)(M)	P1091176		1-	B	
J 8402	CONNECTOR				SB20-06WS	P0090613		1-	B	
J 8403	CONNECTOR				SB20-04WS	P0090611		1-	B	
R 8401	CHIP RES.	10ohm	1/10W	5%	RMC1/10T 100J	J24205100		8-	B	
S 8401	ROTARY ENCODER				EC11G1524405	Q9000883		1-	A	
VR8401	POT.				RK11K1140A3L 10KB	J60800245		1-	A	
VR8402	POT.				RK11K1140A3L 10KB	J60800245		1-	A	
VR8403	POT.				RK11K1140A3L 10KB	J60800245		1-	A	
VR8404	POT.				RK11K1140A3L 10KB	J60800245		1-	A	

VR-A Unit

Note:

VR-B Unit

Circuit Diagram

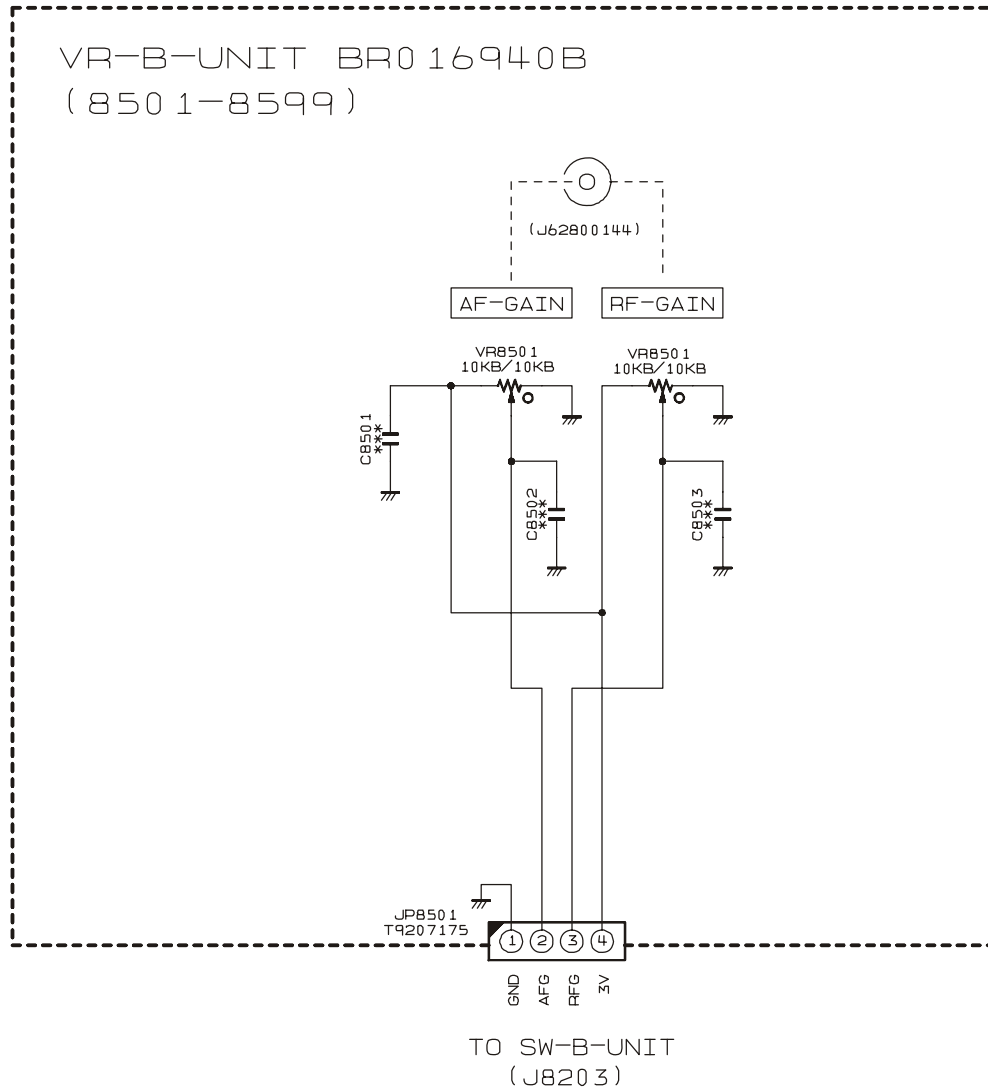

VR-B Unit

Parts Layout

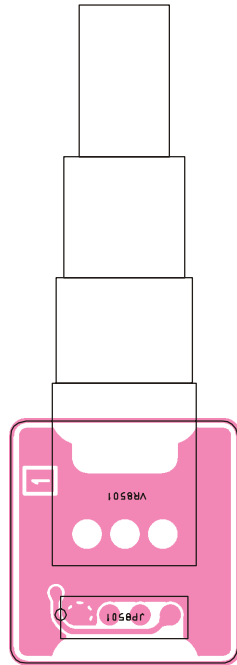

Side A

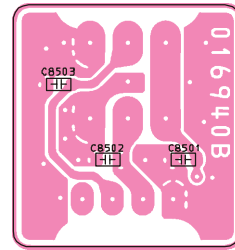

Side B

Parts List

REF	DESCRIPTION	VALUE	V/W	TOL.	MFR'S DESIG	VXSTD P/N	VERS.	LOT	SIDE	LAY ADR
	PCB with Components					CB4039001				
	Printed Circuit Board					FR016940B		1-		
JP8501	WIRE ASSY				AH010H	T9207175		1-	A	
VR8501	POT.				RK0972210-F25-C0-B103	J62800144		1-	A	

PHONE Unit

Circuit Diagram (Lot. 1~)

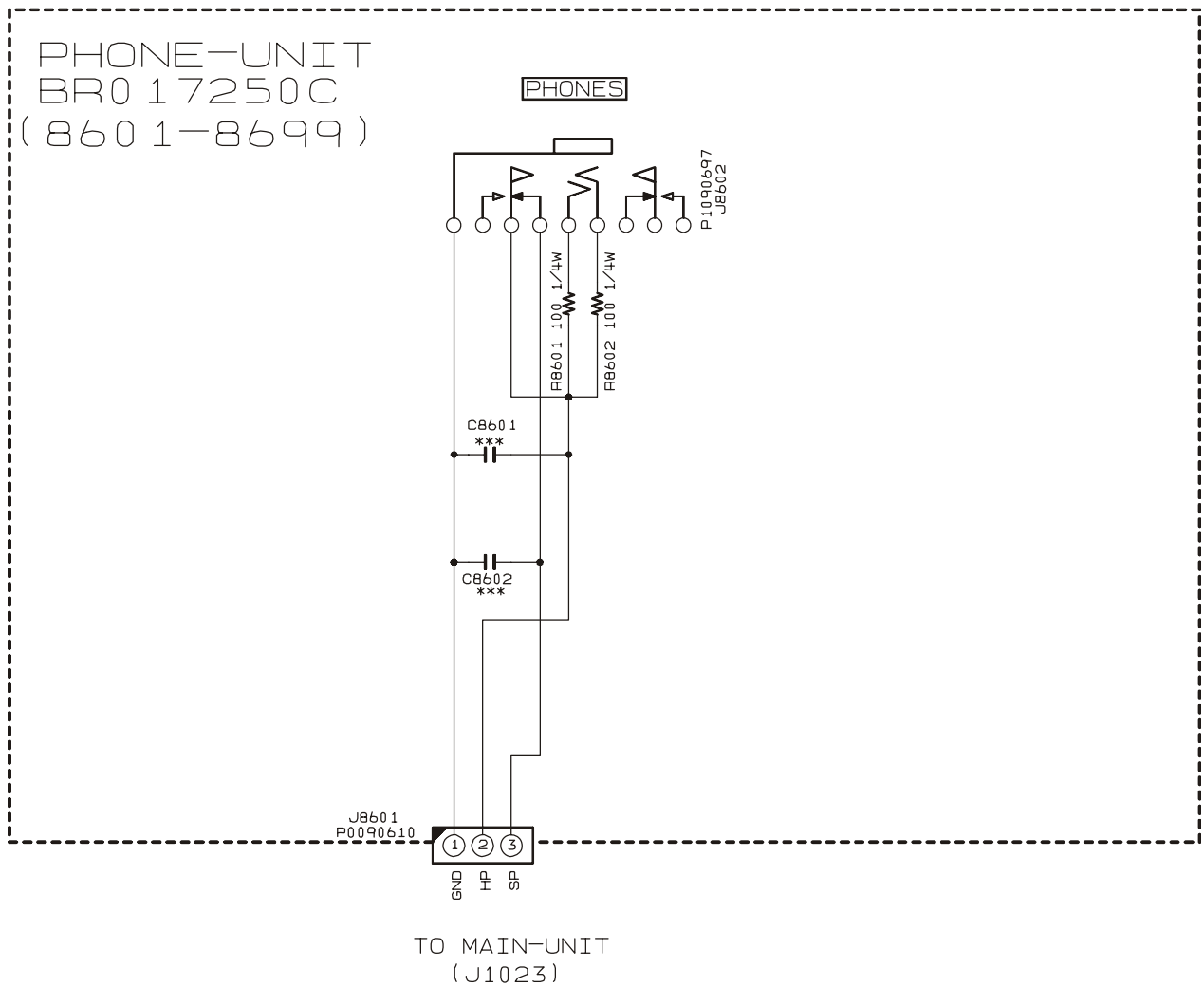

Parts Layout (Lot. 1~)

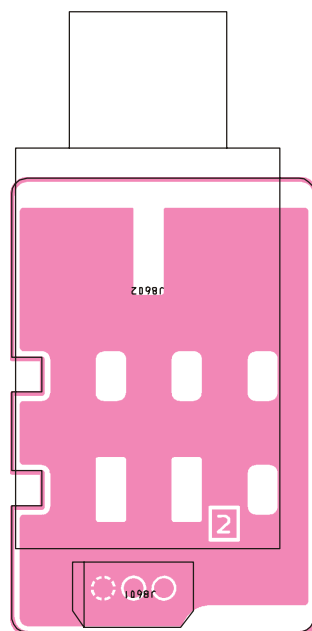

Side A

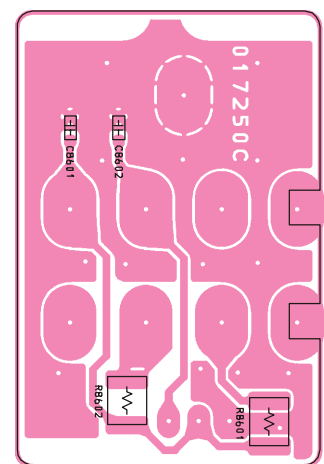

Side B

PHONE-1

PHONE Unit

Circuit Diagram (Lot. 6~)

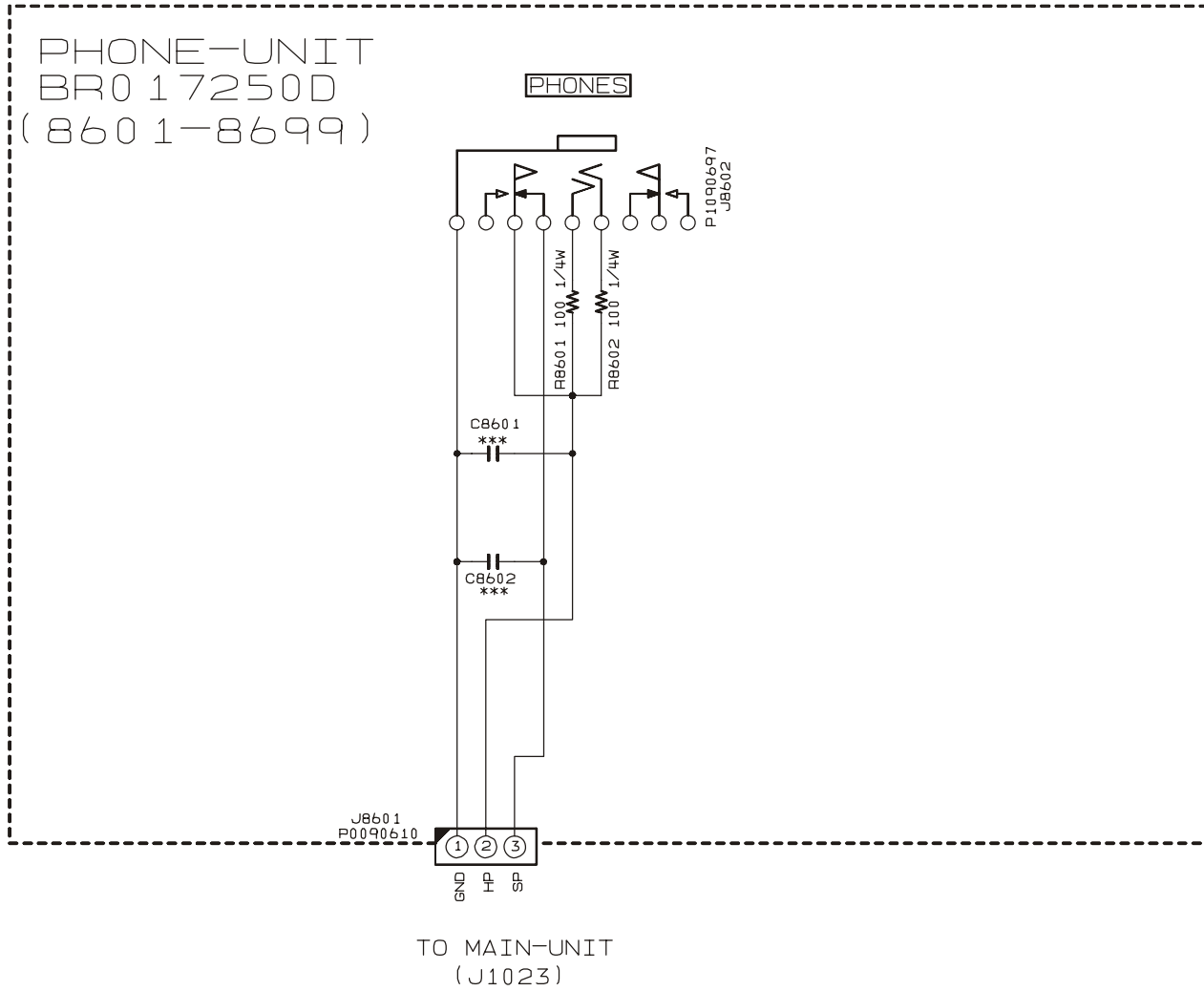

Parts Layout (Lot. 6~)

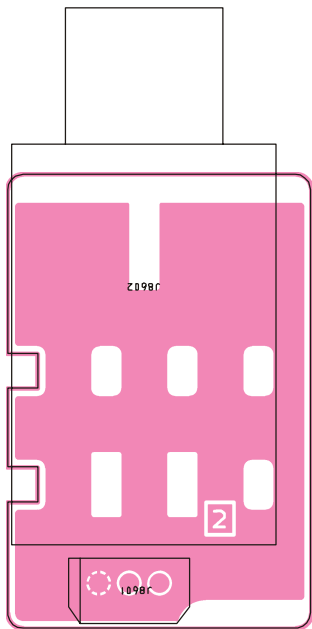

Side A

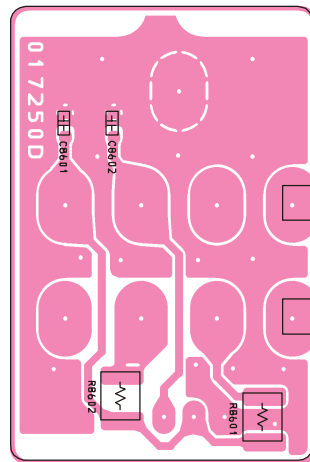

Side B

PHONE Unit

Parts List

REF	DESCRIPTION	VALUE	V/W	TOL.	MFR'S DESIG	VXSTD P/N	VERS.	LOT	SIDE	LAY ADR
	PCB with Components					CB4142001				
	Printed Circuit Board					FR017250C		1-		
	Printed Circuit Board					FR017250D		6-		
J 8601	CONNECTOR				SB20-03WS	P0090610		1-	A	
J 8602	CONNECTOR				HLJ2305-0130609	P1090823		1-	A	
R 8601	CHIP RES.	100	1/4W	5%	RMC1/4 101JATP	J24245101		1-	B	
R 8602	CHIP RES.	100	1/4W	5%	RMC1/4 101JATP	J24245101		1-	B	

PHONE Unit

Note

MIC Unit

Circuit Diagram

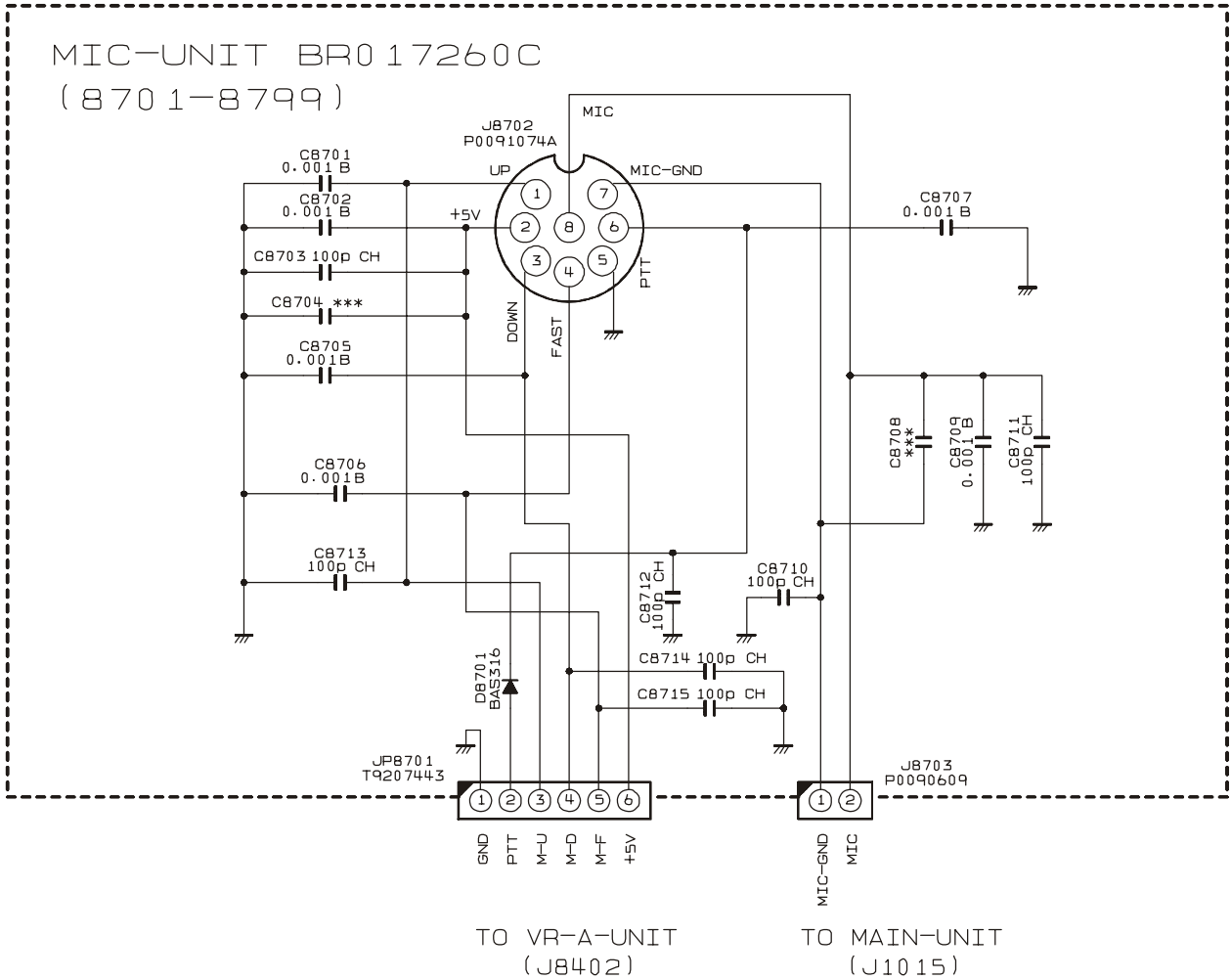

MIC Unit

Parts Layout

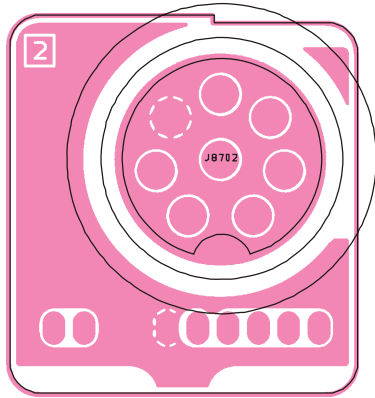

Side A

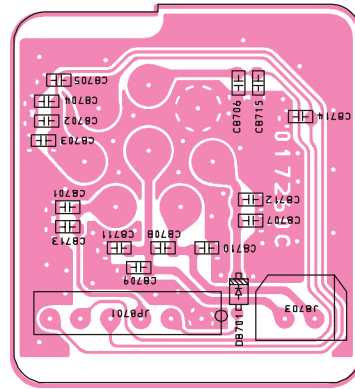

Side B

Parts List

REF	DESCRIPTION	VALUE	V/W	TOL.	MFR'S DESIG	VXSTD P/N	VERS.	LOT	SIDE	LAY ADR	
	PCB with Components						CB4143001				
	Printed Circuit Board						FR017260C		1-		
C 8701	CHIP CAP.	0.001uF	50V	B	GRM188B11H102KA01D	K22174809		1-	B		
C 8702	CHIP CAP.	0.001uF	50V	B	GRM188B11H102KA01D	K22174809		1-	B		
C 8703	CHIP CAP.	100pF	50V	CH	GRM1882C1H101JA01D	K22174235		1-	B		
C 8705	CHIP CAP.	0.001uF	50V	B	GRM188B11H102KA01D	K22174809		1-	B		
C 8706	CHIP CAP.	0.001uF	50V	B	GRM188B11H102KA01D	K22174809		1-	B		
C 8707	CHIP CAP.	0.001uF	50V	B	GRM188B11H102KA01D	K22174809		1-	B		
C 8709	CHIP CAP.	0.001uF	50V	B	GRM188B11H102KA01D	K22174809		1-	B		
C 8710	CHIP CAP.	100pF	50V	CH	GRM1882C1H101JA01D	K22174235		1-	B		
C 8711	CHIP CAP.	100pF	50V	CH	GRM1882C1H101JA01D	K22174235		1-	B		
C 8712	CHIP CAP.	100pF	50V	CH	GRM1882C1H101JA01D	K22174235		1-	B		
C 8713	CHIP CAP.	100pF	50V	CH	GRM1882C1H101JA01D	K22174235		1-	B		
C 8714	CHIP CAP.	100pF	50V	CH	GRM1882C1H101JA01D	K22174235		1-	B		
C 8715	CHIP CAP.	100pF	50V	CH	GRM1882C1H101JA01D	K22174235		1-	B		
C 8716	AL.ELECTRO.CAP.	1000uF	6.3V		ECA0JM102 1000UF	K40089038		4-7			
D 8701	DIODE				BAS316	G2070716		1-	B		
D 8701	DIODE				1SS357(TPH3.F)	G2070346		7-	B		
J 8702	CONNECTOR				FM214-8SMPT-NI	P0091074A		1-	A		
J 8703	CONNECTOR				SB20-02WS	P0090609		1-	B		
JP8701	WIRE ASSY				AH031H 90MM6P	T9207443		1-	B		
JP8701	WIRE ASSY				AH031H 90MM6P	T9207443		4-	B		
R 8701	CARBON FILM RES.	2.2	1/6W	5%	RD16TPJ2R2 2.2	J07225229		4-7			

KEY Unit

Circuit Diagram (Lot. 1~)

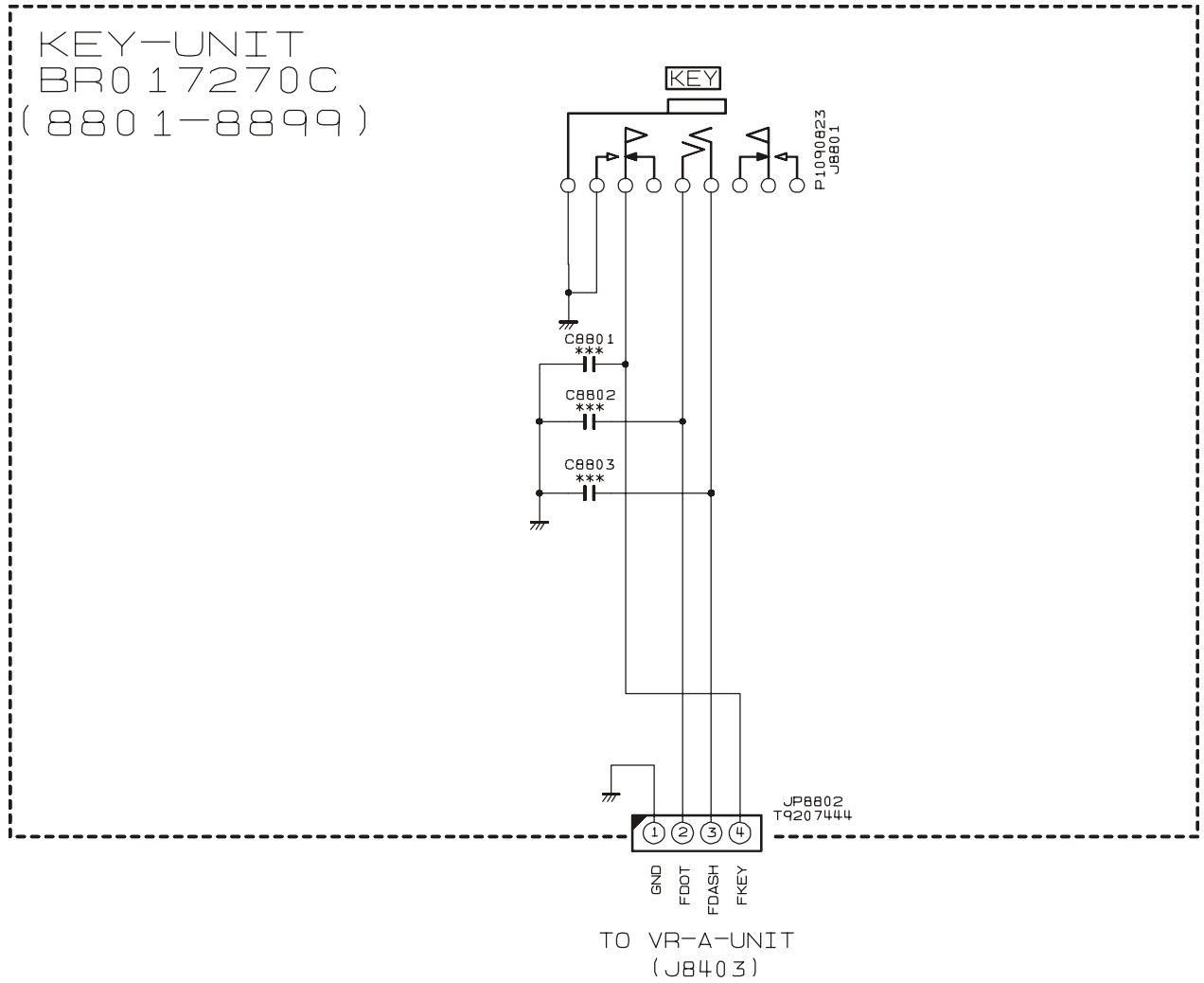

Parts Layout (Lot. 1~)

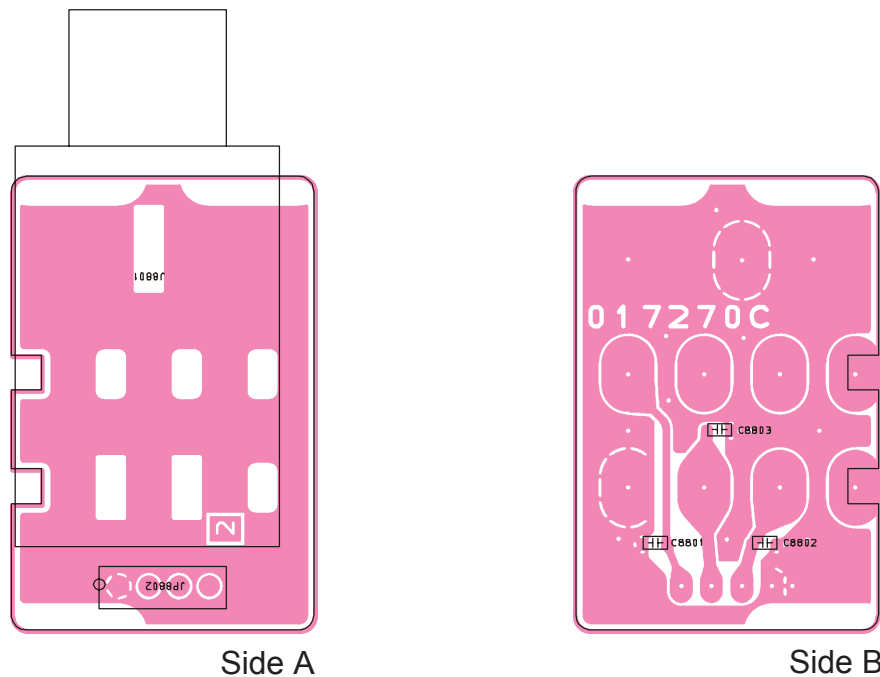

KEY Unit

Parts List

REF	DESCRIPTION	VALUE	V/W	TOL.	MFR'S DESIG	VXSTD P/N	VERS.	LOT	SIDE	LAY ADR
	PCB with Components					CB4144001				
	Printed Circuit Board					FR017270C		1-		
	Printed Circuit Board					FR017270D		6-		
J 8801	CONNECTOR				HLJ2305-0130609	P1090823		1-	A	
JP8802	WIRE ASSY				AH031H 60MM4P	T9207444		1-	A	

KEY Unit

Note

DVS-6 (Option)

Circuit Diagram

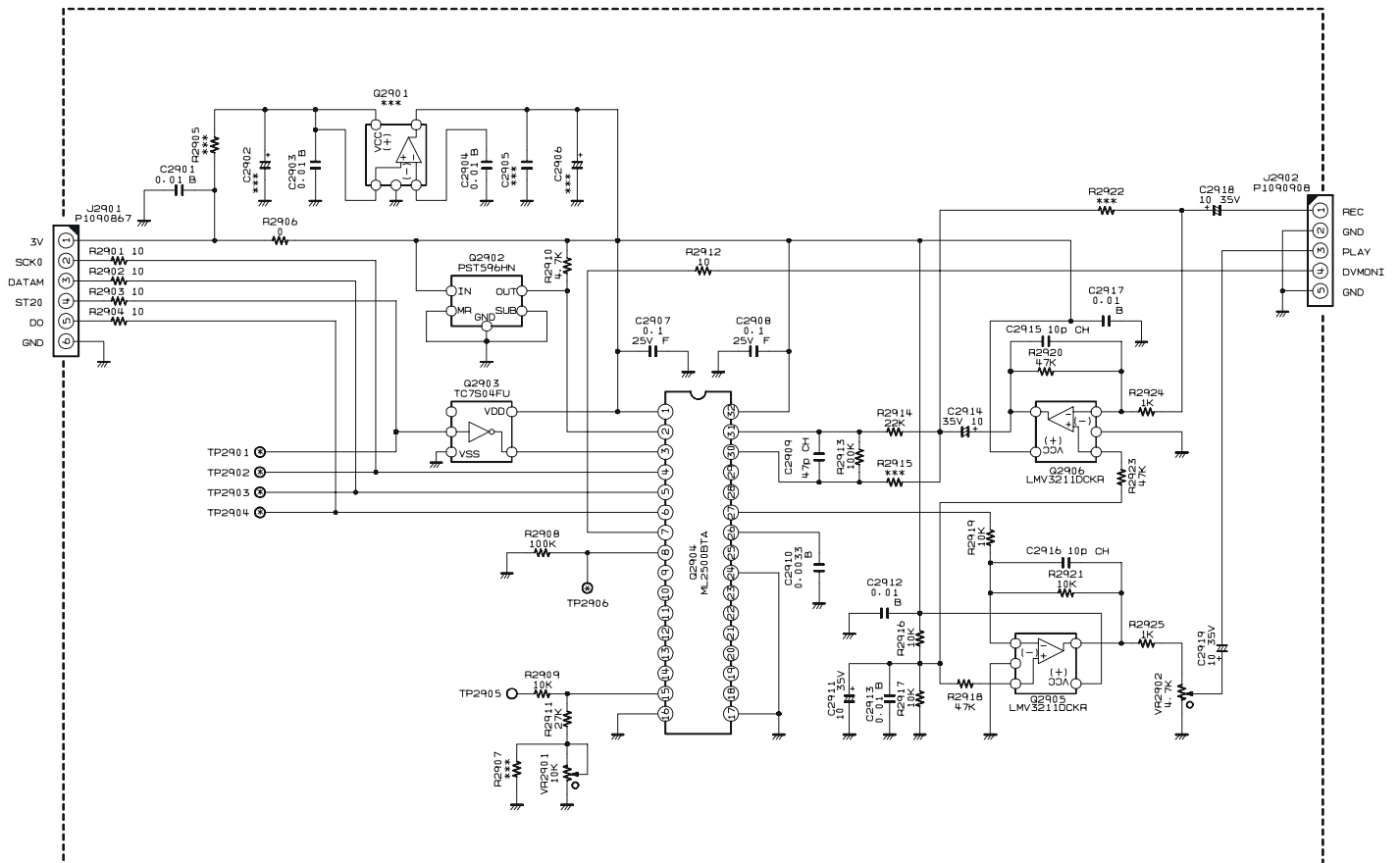

Parts Layout

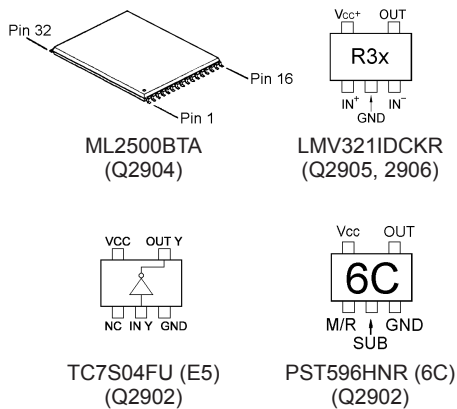

Side A

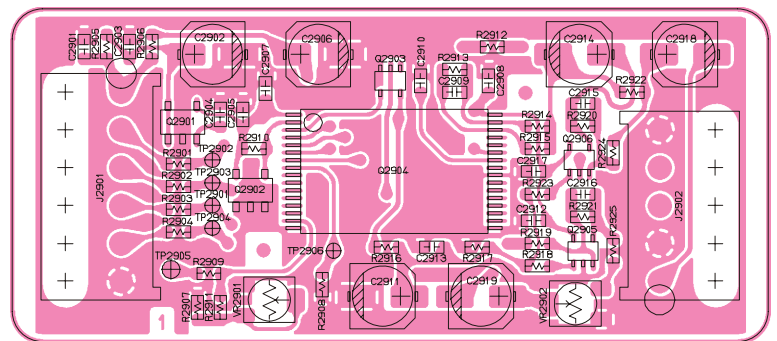

Side B

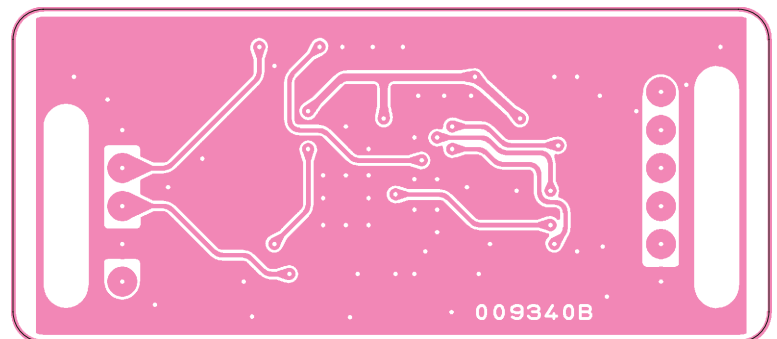

DVS-6 (Option)

Parts List

REF	DESCRIPTION	VALUE	V/W	TOL.	MFR'S DESIG	VXSTD P/N	VERS.	LOT	SIDE	LAY ADR
	Printed Circuit Board					FR0093400		1-		
C 2901	CHIP CAP.	0.01uF	50V	B	GRM188B11H103KA01D	K22174823		1-	A	
C 2903	CHIP CAP.	0.01uF	50V	B	GRM188B11H103KA01D	K22174823		1-	A	
C 2904	CHIP CAP.	0.01uF	50V	B	GRM188B11H103KA01D	K22174823		1-	A	
C 2907	CHIP CAP.	0.1uF	25V	F	GRM39F104Z25PT	K22145001		1-	A	
C 2908	CHIP CAP.	0.1uF	25V	F	GRM39F104Z25PT	K22145001		1-	A	
C 2909	CHIP CAP.	47pF	50V	CH	GRM1882C1H470JA01D	K22174227		1-	A	
C 2910	CHIP CAP.	0.0033uF	50V	B	GRM188B11H332KA01D	K22174831		1-	A	
C 2911	AL.ELECTRO.CAP.	10uF	35V		EEE1VA100WR	K48160006		1-	A	
C 2912	CHIP CAP.	0.01uF	50V	B	GRM188B11H103KA01D	K22174823		1-	A	
C 2913	CHIP CAP.	0.01uF	50V	B	GRM188B11H103KA01D	K22174823		1-	A	
C 2914	AL.ELECTRO.CAP.	10uF	35V		EEE1VA100WR	K48160006		1-	A	
C 2915	CHIP CAP.	10pF	50V	CH	GRM1882C1H100JA01D	K22174211		1-	A	
C 2916	CHIP CAP.	10pF	50V	CH	GRM1882C1H100JA01D	K22174211		1-	A	
C 2917	CHIP CAP.	0.01uF	50V	B	GRM188B11H103KA01D	K22174823		1-	A	
C 2918	AL.ELECTRO.CAP.	10uF	35V		EEE1VA100WR	K48160006		1-	A	
C 2919	AL.ELECTRO.CAP.	10uF	35V		EEE1VA100WR	K48160006		1-	A	
J 2901	CONNECTOR				IMSA-9133S-06D	P1090867		1-	A	
J 2902	CONNECTOR				IMSA-9133S-05D	P1090908		1-	A	
Q 2902	IC				PST596HNR	G1092574		1-	A	
Q 2903	IC				TC7S04FU(TE85R.F)	G1091530		1-	A	
Q 2904	IC				ML2500BTA	G1093715		1-	A	
Q 2905	IC				LMV321IDCKR	G1093969		1-	A	
Q 2906	IC				LMV321IDCKR	G1093969		1-	A	
R 2901	CHIP RES.	10	1/16W	5%	RMC1/16 100JATP	J24185100		1-	A	
R 2902	CHIP RES.	10	1/16W	5%	RMC1/16 100JATP	J24185100		1-	A	
R 2903	CHIP RES.	10	1/16W	5%	RMC1/16 100JATP	J24185100		1-	A	
R 2904	CHIP RES.	10	1/16W	5%	RMC1/16 100JATP	J24185100		1-	A	
R 2906	CHIP RES.	0	1/16W	5%	RMC1/16 000JATP	J24185000		1-	A	
R 2908	CHIP RES.	100k	1/16W	5%	RMC1/16 104JATP	J24185104		1-	A	
R 2909	CHIP RES.	10k	1/16W	5%	RMC1/16 103JATP	J24185103		1-	A	
R 2910	CHIP RES.	4.7k	1/16W	5%	RMC1/16 472JATP	J24185472		1-	A	
R 2911	CHIP RES.	27k	1/16W	5%	RMC1/16 273JATP	J24185273		1-	A	
R 2912	CHIP RES.	10	1/16W	5%	RMC1/16 100JATP	J24185100		1-	A	
R 2913	CHIP RES.	22k	1/16W	5%	RMC1/16 223JATP	J24185223		1-	A	
R 2914	CHIP RES.	22k	1/16W	5%	RMC1/16 223JATP	J24185223		1-	A	
R 2916	CHIP RES.	10k	1/16W	5%	RMC1/16 103JATP	J24185103		1-	A	
R 2917	CHIP RES.	10k	1/16W	5%	RMC1/16 103JATP	J24185103		1-	A	
R 2918	CHIP RES.	47k	1/16W	5%	RMC1/16 473JATP	J24185473		1-	A	
R 2919	CHIP RES.	10k	1/16W	5%	RMC1/16 103JATP	J24185103		1-	A	
R 2920	CHIP RES.	47k	1/16W	5%	RMC1/16 473JATP	J24185473		1-	A	
R 2921	CHIP RES.	10k	1/16W	5%	RMC1/16 103JATP	J24185103		1-	A	
R 2923	CHIP RES.	47k	1/16W	5%	RMC1/16 473JATP	J24185473		1-	A	
R 2924	CHIP RES.	10k	1/16W	5%	RMC1/16 103JATP	J24185103		1-	A	
R 2925	CHIP RES.	3.3k	1/16W	5%	RMC1/16 332JATP	J24185332		1-	A	
VR2901	POT.	10k			RH03A3A14X 10K	J51807103		1-	A	



Copyright 2010
VERTEX STANDARD CO., LTD.
All rights reserved

No portion of this manual
may be reproduced without
the permission of
VERTEX STANDARD CO., LTD.