

YAESU SYSTEM 600
HF Multimode
Commercial
Amateur
Marine
Transceiver
Dealer's Manual

YAESU MUSEN CO., LTD.
4-8-8 Nakameguro, Meguro-Ku, Tokyo 153-8644, Japan
YAESU U.S.A.
17210 Edwards Rd., Cerritos, CA 90703, U.S.A.
YAESU EUROPE B.V.
P.O. Box 75525 1118 ZN, Schiphol, The Netherlands
YAESU UK LTD.
Unit 12, Sun Valley Business Park, Winnall Close
Winchester, Hampshire, SO23 0LB, U.K.
YAESU GERMANY GmbH
Am Kronberger Hang 2, D-65824 Schwalbach, Germany
YAESU HK LTD.
11th Floor Tsim Sha Tsui Centre, 66 Mody Rd.,
Tsim Sha Tsui East, Kowloon, Hong Kong

Table of Contents

<p>Description 1</p> <p>I. Specifications 2</p> <p>II. Controls and Connectors 3</p> <p style="padding-left: 20px;"><i>II-1. Front Panel Controls 3</i></p> <p style="padding-left: 20px;"><i>II-2. Rear Panel Connections 6</i></p> <p style="padding-left: 20px;"><i>II-3. Microphone Controls 7</i></p> <p>Connector Pinouts 8</p> <p>III. Installation 9</p> <p style="padding-left: 20px;"><i>III-1. Safety Precautions 9</i></p> <p style="padding-left: 20px;"><i>III-2. Preliminary Inspection 10</i></p> <p style="padding-left: 20px;"><i>III-3. Power Requirements and Basic Installation 10</i></p> <p style="padding-left: 40px;">1. DC Power Connections 10</p> <p style="padding-left: 40px;">2. Mobile Mounting 10</p> <p style="padding-left: 40px;">3. Mobile Antenna Considerations 10</p> <p style="padding-left: 40px;">4. Mobile Station Grounding 12</p> <p style="padding-left: 40px;">5. Base Station Installation 12</p> <p style="padding-left: 40px;">6. Base Station Antenna Considerations 13</p> <p style="padding-left: 40px;">7. Base Station Grounding 14</p> <p style="padding-left: 20px;"><i>III-4. Accessory Interfacing 15</i></p> <p style="padding-left: 40px;">III-4A. Accessories & Options 15</p> <p style="padding-left: 20px;"><i>Optional Accessories 16</i></p> <p style="padding-left: 40px;">III-4B. Front Panel Interconnections 18</p> <p style="padding-left: 40px;">III-4C. Rear Panel Interconnections 18</p> <p style="padding-left: 40px;">III-4D. Installation of Internal Accessories 20</p>	<p>IV. Configuration and Programming 23</p> <p style="padding-left: 20px;"><i>IV-1. Basic Steps 23</i></p> <p style="padding-left: 20px;"><i>IV-2. Configuration Key Information 23</i></p> <p style="padding-left: 40px;">IV-2A. Marine "ITU-Disable" Jumper 23</p> <p style="padding-left: 20px;"><i>IV-3. Memory Channel Programming 24</i></p> <p style="padding-left: 40px;">IV-3A. Frequency Determination 24</p> <p style="padding-left: 40px;">IV-3B. Memory Channel Storage 25</p> <p style="padding-left: 40px;">IV-3C. Alpha Tag Storage 26</p> <p style="padding-left: 40px;">IV-3D. SELCALL ID Code Programming (J3E Mode Only) 26</p> <p style="padding-left: 20px;"><i>IV-4. Performance Verification: Transceiver 27</i></p> <p style="padding-left: 20px;"><i>IV-5. Performance Verification: FC-800 28</i></p> <p style="padding-left: 20px;"><i>IV-6. Cloning 29</i></p> <p style="padding-left: 20px;"><i>IV-7. Final Fleet Performance Verification ITU Channels 30</i></p> <p>V. Appendix 31</p> <p style="padding-left: 20px;"><i>V-1. Computer Programming Using the CAT System 31</i></p> <p style="padding-left: 40px;">Coding Examples 35</p> <p style="padding-left: 20px;"><i>V-2. Memory Backup and System 600 Switch-On Options 36</i></p> <p style="padding-left: 20px;"><i>V-3. General Coverage Operation 37</i></p> <p style="padding-left: 40px;">Startup Procedures 38</p> <p style="padding-left: 40px;">Reception 38</p> <p style="padding-left: 40px;">Frequency and Channel Selection 38</p> <p style="padding-left: 40px;">2182 Emergency Channel Mode 40</p> <p style="padding-left: 40px;">Front Panel Locking 40</p> <p style="padding-left: 40px;">Memory Channel Storage 40</p> <p style="padding-left: 40px;">Alpha Tag Programming 41</p> <p style="padding-left: 40px;">Transmission 42</p> <p style="padding-left: 40px;">Antenna Tuning Procedures 42</p> <p style="padding-left: 40px;">Shortwave Listening 43</p> <p style="padding-left: 40px;">Weatherfax Monitoring 43</p> <p style="padding-left: 40px;">Dual Watch 44</p> <p style="padding-left: 40px;">SELCALL (Selective Calling) Operation (J3E Mode Only) 44</p> <p style="padding-left: 40px;">Encrypted Transmission/Reception (requires FVP-24 Module) 45</p>
--	--

Description

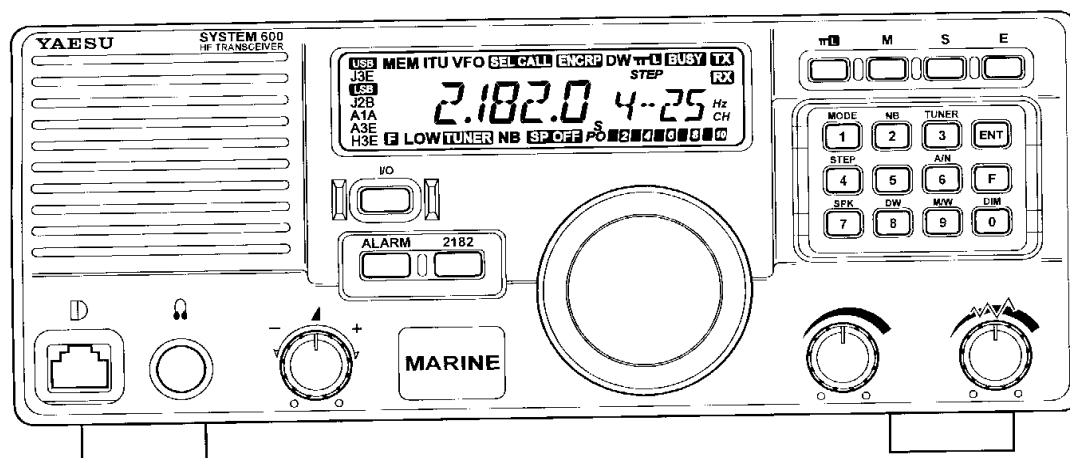

The Yaesu System 600 is a low-cost, integrated HF communications transceiver designed for the worldwide Land Mobile, Marine, and Amateur Radio markets. Utilizing an innovative Configuration Key technique, the System 600 is easily configured for the unique operational and regulatory requirements of the nation and service in which it is to be used.

The Yaesu System 600 provides continuous receiver coverage from 50 kHz to 29.99999 MHz, and transmitter coverage, determined by the Configuration Key, as appropriate for the user's application. Operating modes provided include J2B (USB or LSB), J3E (USB or LSB), A1A, A3E, and H3E (only on 2182 kHz in the Marine version), making the System 600 ideal for a wide variety of voice, telegraphy, and many data communication applications.

Advanced features of the Yaesu System 600 include 100 memory channels, arranged in four banks of 25 channels each, keyboard frequency entry with frequency resolution to 10 Hz (100 Hz in Memory mode),

and Alpha-Numeric labeling of Memory channels. For ease in programming fleet systems, a handy Clone feature is provided. And a Yaesu-original selective calling feature allows paging of a single transceiver or groups of transceivers by a dispatch center.

Available options include the FC-800 Automatic (External) Antenna Tuner, FP-800 AC Power Supply, YA-30 Broadband Dipole Antenna, YA-007 Mobile Antenna, MD-100A8X Desk Microphone, SP-7 External Speaker, SP-8 External Speaker with Audio Filters, YH-77STA Lightweight Headphones, TCXO-4 High-Stability Master Oscillator, and the FVP-24 Encryption Module (not available for the Amateur Radio version).

This manual includes installation, configuration, and interfacing instructions covering the wide variety of applications for which the Yaesu System 600 is designed, so as to allow the dealer or installer to ensure maximum customer satisfaction with the Yaesu System 600 HF Transceiver.

I. Specifications

General

Receiver Frequency Range:

50 kHz ~ 29.99999 MHz

Transmitter Frequency Range:

1.8 ~ 29.99999 MHz (Selected memory channels, depending on ITU Marine channels or general coverage configuration)

Emission Modes: J3E (USB, LSB)

A1A (CW), A3E (AM)

H3E (2182 Mode only, Marine version only)

J2B (USB, LSB)

Frequency Synthesizer Step Resolution:

10 Hz, 100 Hz, 1 kHz

Frequency Stability:

±10 ppm from 0 °C ~ +40 °C (Standard Version)

±2 ppm from 0 °C ~ +50 °C (w/TCXO-4 Option)

Operating Temperature Range: -10°C ~ +50°C**Antenna Impedance:**

50 Ω nominal (2:1 Maximum Permitted SWR)

Supply Voltage: 13.5 V DC ±10%, negative ground**Power Consumption:**

1.2 A (Receive, no signal)

20 A (Transmit, 100 watts output)

Dimensions (WIID): 244 x 104 x 286 mm**Weight (approx.):** 4.5 kg (9.9 lbs.)

Transmitter

Power Output: 100 watts (J2B, J3E, A1A)

25 watts AM Carrier (A3E, H3E)

Modulation Types:

SSB: Balanced modulator, filtered carrier

AM: Low-level (early stage)

Spurious Radiation: 40 dB below peak output**SSB Carrier Suppression:**

>40 dB below peak output

Undesired Sideband Suppression:

At least 50 dB below peak output @ 1.5 kHz modulation input

SSB Audio Response:

Not more than -6 dB from 400 Hz ~ 2600 Hz

Occupied Bandwidth: A1A: < 0.5 kHz

J2B: < 3.0 kHz, J3E: < 3.0 kHz

H3E: < 3.0 kHz, A3E: < 6.0 kHz

3rd-Order SSB IMD:

-25 dB or better @ 100W PEP (14 MHz)

Microphone Impedance: 500 ~ 600 Ω

Receiver

Circuit Type: Double-conversion Superheterodyne**Intermediate Frequencies:**

1st: 47.055 MHz, 2nd: 8.215 MHz

Sensitivity (for 10 dB S/N):

0.5 ~ 1.8 MHz: J2B/J3E/A1A 2µV, A3E 8µV

1.8 ~ 29.999MHz: J2B/J3E/A1A 0.25µV, A3E 1µV

Squelch Sensitivity:

Better than 2µV (1.8 ~ 29.999MHz)

IF Rejection: Better than 60 dB (1.8 ~ 29.999MHz)**Image Rejection:** Better than 70 dB (1.8 ~ 29.999MHz)**Selectivity:**

J2B/J3E/A3E-Narrow/H3E-Narrow/A1A-Wide 2.2 kHz (-6 dB), 5.0 kHz (-60 dB)

A1A-Narrow 500 Hz (-6 dB), 1.2kHz (-60 dB)

A3E 6.0 kHz (-6 dB), 12.0 kHz (-60 dB)

Clarifier Range: ±300 Hz**Audio Output:**

At least 1.5 watts into 4 Ω (@ 10% THD or less)

Conducted Radiation: Less than -55 dBm**Spurious Responses:**

Below 1 mV equivalent signal level. (Except discrete spurious responses at 5.2428 MHz, 8.2150 MHz, 10.4857 MHz, and 19.6610 MHz)

FC-800 Antenna Tuner

Operating frequency range:

1.8~30 MHz with 12m+ end-fed wire;

3.5~30 MHz with 2.6m whip

Matching impedance: 50 Ohms (unbalanced)**Maximum transmitter power:** 150 watts PEP**Maximum SWR after tuning:**

1.5:1 (if antenna is not a multiple of ½λ)

Required RF power for tuning: 10 watts (±3W)**Tuning time:**

3 s typical, 10 s maximum (for one channel)

Power requirements:

13.5 V DC ±15% @ 700 mA (from FC-800 jack on rear of transceiver)

Operating temperature range:

-30° to +65° C (-22° to +149° F)

Case size (WHD): 264 x 80 x 264 mm**Weight:** 2.1 kg.**Supplied Cables:**

Coaxial Cable (5m), p/n T9101366

Control Cable, 4-wire (5m), p/n T9101419

Specifications may be subject to change without notice.

II. Controls and Connectors

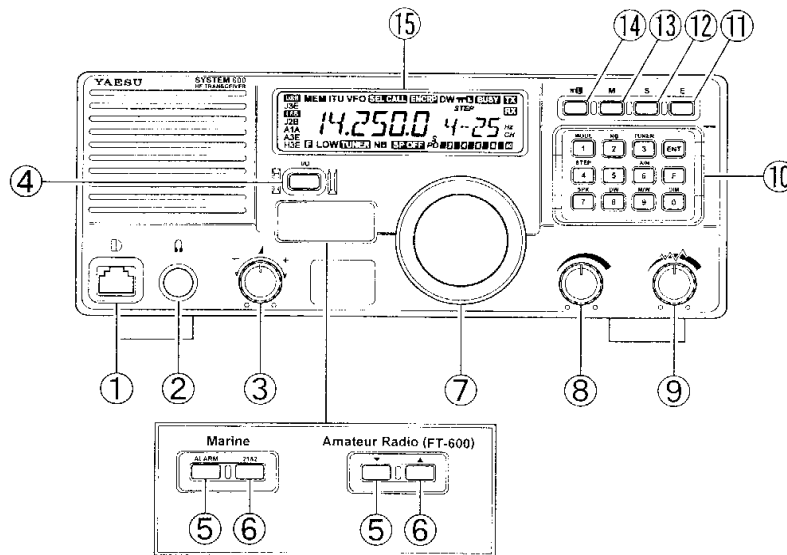

II-1. Front Panel Controls

(1) Microphone Jack

This modular jack accepts microphone voice input, as well as scanning and PTT (Push To Talk) control from the microphone. Specified microphone impedance is 500 ~ 600 Ω .

(2) Headphone Jack

Use this jack for connection to Yaesu YH-77STA or equivalent headphones. Specified headphone impedance is 4 ~ 8 Ω .

(3) Clarifier: Receiver Offset Tuning (- Δ +)

Use this control for fine tuning around the current operating frequency. Rotating the Clarifier control tunes the receiver (up to ± 300 Hz) *without affecting the transmit frequency*. The center detent of this control yields zero offset between the transmit and receive frequencies.

(4) Power (I/O)

This is the main Power On/Off switch for the transceiver. The switch is a locking type.

(5) ∇ /ALARM

In most transceiver configurations, this button serves as a frequency, memory, or band stepping control which causes *downward* frequency, memory channel, or band change.

In the *Marine* configuration, pressing this button activates the alarm generator, with the alarm tone emanating from the Speaker (receive audio is muted,

and no transmission occurs). To *transmit* the alarm tone, press *both* the ∇ /ALARM key and the \blacktriangle /2182 key (described next).

This key is non-functional during frequency or memory channel entry.

(6) \blacktriangle /2182

In most transceiver configurations, this button serves as a frequency, memory, or band stepping control which causes *upward* frequency, memory channel, or band change.

In the *Marine* configuration, pressing this button places the System 600 in the "Emergency Channel" mode, with the following results:

(A) The transceiver is instantly set to 2182 kHz in the H3E mode;

(B) On the LCD, ECH appears on the display, indicating Emergency Channel operation.

This key is non-functional during frequency or memory channel entry.

(7) Main Dial

The main dial tunes memory or VFO channels (depending on transceiver configuration) in 50 steps per revolution. It is also used for selecting alpha-numeric characters during "Alpha-Tag" entry.

(8) Volume

This control adjusts the (receiver) audio volume level from the speaker or headphones. Clockwise rotation of this control increases the volume level.

(9) Squelch

This control may be used to silence the receiver when no signals are being received. Clockwise rotation of this control causes the receiver to respond only to progressively *stronger* signals; conversely, counter-clockwise rotation of this control allows progressively *weaker* signals to be heard.

When a signal or noise breaks through the squelch “threshold,” the **BUSY** icon on the main display will be illuminated.

(10) Keypad

The Keypad is used for both frequency entry and/or certain operational commands, depending on the transceiver configuration. The following rules apply during Keypad operation:

- ❑ The *keypad entry* function on the keypad is used on transceiver configurations where direct frequency entry is possible, and is activated by pressing the **ENT** key; thereafter, the digits of the desired operating frequency may be entered.
- ❑ The *primary* function on the keypad—the action which is accomplished by a single keystroke (e.g. **1**, **2**, etc.)—is the function which is printed above the key.
- ❑ The *secondary* function on the keypad—the action which is accomplished by *first* pressing the **F** key *followed by* another key (e.g. **F** + **1**) — is a function which may adjust, modify, or otherwise expand on settings of the transceiver. In other words, pushing **1** will change the operating mode of the transceiver, while pushing **F** + **1** will allow the selectivity filters which apply to that operating mode to be changed.

The keypad functions are as follows:

Keypad Entry Functions

1 ~ **0** These keys are used to enter the operating frequency during direct keypad frequency entry.

Primary Functions

1 This key allows selection of the operating mode:

J3E: USB (Upper Sideband) or LSB (Lower Sideband) SSB Voice transmission and reception.

J2B: AFSK (Audio Frequency-Shifted Keying) Data transmission and reception, using LSB as the default sideband.

A1A: CW (Continuous Wave—Morse Code) telegraphy.

A3E: AM (Double Sideband with full carrier).

The H3E (Single Sideband AM) mode is only activated via the **2182** key in the Marine configuration. It is not possible to change modes in the Land Mobile configuration, and only possible in the **FM** (General Coverage reception) mode in the Marine configuration.

The operating mode is displayed, for operator reference, along the left side of the main LCD display.

2 Pushing this key activates the Noise Blanker. When the Noise Blanker is activated, the **NB** icon on the Main Display becomes illuminated.

3 Pushing this key turns the FC-800 Antenna Tuner option on and off. When the Tuner is activated, the **TX** icon on the display becomes illuminated.

ENT Pushing this key activates or terminates frequency entry from the keypad.

4 Pushing this key changes the synthesizer steps in the VFO operating mode, if enabled in the transceiver configuration in use.

6 Pushing this key toggles the main display area between the “frequency display” and “Alpha-Tag” (if programmed) modes.

F Pushing this Function key prior to another keystroke activates the *secondary* keystroke function.

7 Pushing this key turns the internal speaker (or external speaker, if used) on and off. If the speaker is switched off, the **SPOFF** icon on the Main Display becomes illuminated.

8 Pushing this key activates or deactivates the Dual Watch feature, which allows a frequency other than the main operating frequency to be checked periodically for activity.

When the Dual Watch function is activated, the **DW** icon on the Main Display becomes illuminated.

9 Pushing this key activates the Memory Write mode, used for entry of operating frequencies into memory locations.

0 Pushing this key allows selection of the display brightness. Two levels of brightness are available.

Secondary Functions

F + **1** These keystrokes allow Wide/Narrow filter selection in the J2B and A1A modes (only).

(F) + ^{TMR}3 These keystrokes cause all memory channels in MB1 (Memory Bank 1) to be tuned by the FC-800 Automatic Antenna Tuner.

(F) + ^{OW}8 These keystrokes allow selection of the desired "Resume" modes, using the following selections:

TIME Dual Watch will resume scanning ten seconds after it stops on a signal, whether or not that station is still transmitting.

[RRR] Dual Watch will resume five seconds after the signal which caused the scanning to stop disappears (and the **BUSY** icon disappears from the display).

(11) E

This key activates the Encryption mode. When this feature is activated, the **ENCRP** icon on the Main Display becomes illuminated.

(12) S

Pushing this key activates the Selective Calling feature. When this feature is activated, the **SEL CALL** icon on the Main Display becomes illuminated.

(13) M

Pushing this key allows selection of the various VFO and/or Memory Bank combinations, depending on the configuration of the transceiver in use. For example, on the Land Mobile version, repeated pushes of this key causes MB1, MB2, MB3, and MB4 to be chosen in that order, returning to MB1 after MB4. The specific memory channel *within the selected memory bank* is chosen via one of the Up/Down switches or the Main Dial.

(14) Lock (L)

When this key is pushed, all keys on the front panel (except the **2182** and **ALARM** keys in the Marine version and the **L** key itself) are locked out and cannot be used. This feature prevents inadvertent changing of the transceiver operating frequency, mode, etc.

(15) LCD Display

This multi-function LCD (Liquid Crystal Display) includes frequency readout or Alpha-Tag labeling of

the channel in use, plus a Bar Graph which reads out differently on transmit as opposed to receive:

On transmit, the Bar Graph indicates transmitter power output on a scale of 10 watts per segment; accordingly, a reading of **10** corresponds to 100 watts of power output.

On receive, the Bar Graph indicates the relative strength of the incoming signal (with **10** corresponding to a signal level of 100 dB above 1 mV).

The right side of the LCD field is used to display the current memory channel number. Memory channels are presented in hyphenated form, with the Memory Bank first, followed by the Memory Channel *within that bank* second. Thus, the designation **4-25** indicates Memory Channel #25 in Memory Bank #4.

Surrounding the Frequency/AlphaTag/Memory Channel display area are a series of icons which provide visual confirmation of transceiver status. These icons include:

USB Upper Sideband mode is in use.

J3E SSB Mode (**USB** or **LSB** will also be lit) is in use.

LSB Lower Sideband mode is in use.

J2B AFSK Mode (**USB** or **LSB** will also be lit) is in use.

A1A CW (Morse Code Telegraphy) mode is in use.

A3E AM (Double Sideband plus carrier) mode is in use.

H3E AM (Single Sideband plus carrier) mode is in use (Marine version only, in 2182 Emergency Channel mode).

MEM Frequency/mode control is from Memory system.

ITU Frequency/mode control is from special "ITU Memory" system; active in Marine version only.

VFO Frequency control is from Main Dial; not active in Land Mobile version, restricted in Marine version.

SEL CALL Selective Calling system is in use.

ENCRP Encryption system is in use.

DW Dual Watch feature is active.

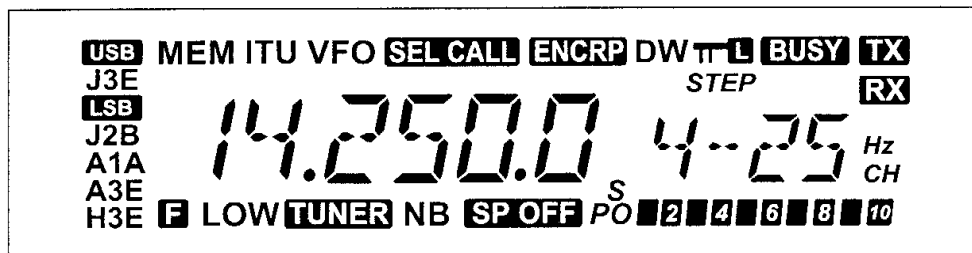

TL The Front Panel Lockout feature is active.

BUSY A signal strong enough to override the Squelch threshold is being received. In the SELCALL mode, signals *not* sending the appropriate selective-calling code will activate the **BUSY** indicator, but will *not* be heard.

TX The transceiver is in the Transmit mode.

RX The transceiver is in the Receive mode.

SP OFF The internal speaker has been turned off via the **7** key.

NB The Noise Blanker is activated.

TUNER The FC-800 Automatic Antenna Tuner is activated.

F The **F** key on the keypad has been pushed to activate the secondary keypad functions. The **F** icon will disappear after five seconds if no further keystrokes are completed.

II-2. Rear Panel Connections

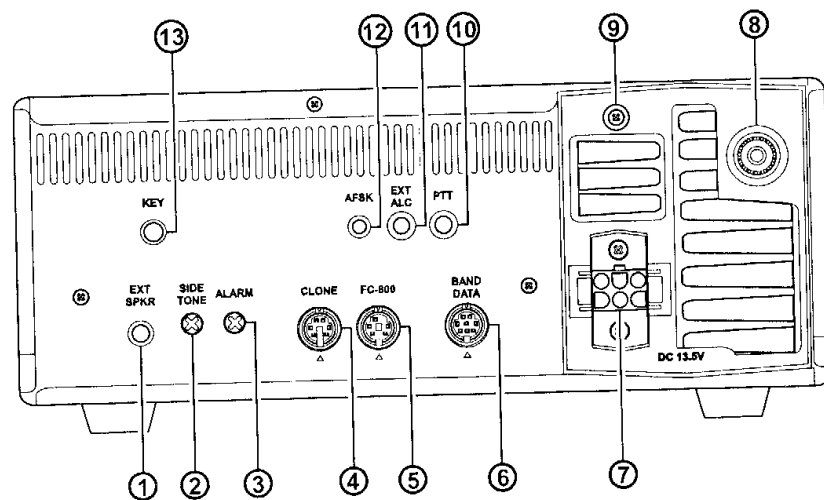

(1) EXT SPKR

This 3.5-mm miniature phone jack provides receiver audio output for an external speaker. Available audio output is 1.5watts, and the permitted impedance is 4 to 16 Ω . Insertion of a plug into this jack automatically disables the internal speaker; insertion of headphones into the *front panel* headphone jack disables audio from *both speakers*.

(2) SIDE TONE

This is an access hole for adjustment of the CW (A1A) sidetone monitor level. This potentiometer also adjusts the level of the SELCALL alert tone, as well as the front panel "Beep" tone. Adjust the potentiometer inside, using a small Phillips screwdriver, for a comfortable sidetone level.

(3) ALARM

This is an access hole for the level control for the (Marine version) Alarm feature when in the "2182" mode. Adjust the potentiometer inside, using a small Phillips screwdriver, for a suitable alarm level.

(4) CLONE

This 6-pin mini-DIN input/output jack allows external computer control of the System 600, or Cloning by a dealer or installer during fleet installation. Signal levels are TTL (0 and 5 V DC). Pinout is on page 8, and data formats are described in the CAT System chapter of the Appendix.

(5) FC-800

This 5-pin mini-DIN jack is for interconnection to the optional FC-800 External Antenna Tuner. Pinout is on page 8.

(6) BAND DATA

This 8-pin mini-DIN jack is for interconnection to a station accessory such as a linear amplifier. Pinout is on page 8.

(7) POWER

This is the main DC power input jack for the System 600 transceiver. Pinout is shown here, and you must be absolutely certain to follow the connection specification precisely!

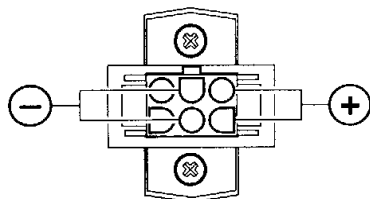
**(8) ANTenna**

This PL-259 ("M" Type) connector is used for connection of the coaxial feedline from the antenna. When the optional FC-800 External Antenna Tuner is used, the RF interconnection cable from the FC-800 connects here, while the antenna wire or whip connects to the FC-800.

(9) Ground Lug

Connect your station ground here, using a heavy, braided cable for the connection to your station's ground bus.

(10) PTT

This RCA jack accepts external **Push To Talk** control from an external device. Shorting the center conductor to the shield will activate the System 600 transmitter, while opening the short will return the transceiver to the receive mode. A footswitch may be attached here, or it may be connected to a data transmission device (such as a Terminal Node Controller) PTT line to allow remote transmit/receive control to be exercised by the TNC. Open circuit voltage is 13.5 V DC, and closed circuit current is approximately 2.5 mA.

(11) ALC

If an external Linear Amplifier (such as the Yaesu FL-7000) is used, or one with power-output-derived ALC (Automatic Level Control), the ALC line from the Amplifier may be connected here. This jack may be used to control the output from the System 600 to prevent over-drive of the amplifier. The ALC control voltage range is 0 to -4 V DC, going more negative as more power cut-back is being exercised. Adjustment of the ALC range is performed at the Linear Amplifier per the manufacturer's instructions.

(12) AFSK

This 3.5-mm three-conductor miniature phone jack provides constant-level receiver output on the *ring* contact, and accepts transmit audio input on the *tip* contact, for use with a Terminal Node Controller (TNC) or other data transmission/reception device (such as a WeatherFax demodulator). Input level should be approximately 60 mV at 3 k Ω , and available receiver output is 100 mV peak at 600 Ω .

(13) KEY

This 3.5-mm miniature phone jack accommodates a telegraph key or output from an electronic telegraphy keying unit. The open circuit voltage is +7 V DC, and closed circuit current is approximately 8 mA. Never connect a device to this jack that is configured for "Negative" or "Grid Block" keying, as serious damage may result.

II-3. Microphone Controls**(1) PTT**

This is the **Push To Talk** switch which activates the transmitter. With the PTT switch pushed in speak into the microphone to convey your message (there is no VOX function available on the System 600).

(2) DWN

This button allows downward manual scanning or channel stepping, depending on the transceiver configuration.

(3) UP

This button allows upward manual scanning or channel stepping, depending on the transceiver configuration.

(4) TONE

This switch activates a low-cut filter which, in Position 2, may be used to reduce unwanted bass response in the operator's voice. Position 1 results in a wider frequency response. Experiment with the two settings to determine which is best for the user's voice pattern.

Note! The FST (Fast) key on the MH-31A8J Hand Microphone has no function with this transceiver model, regardless of the configuration.

Connector Pinouts

Front Panel Microphone Jack

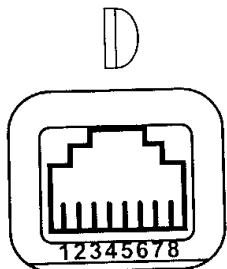

- 1: FAST
- 2: GND
- 3: PTT
- 4: MIC
- 5: MIC GND
- 6: +5V
- 7: UP
- 8: DOWN

CLONE

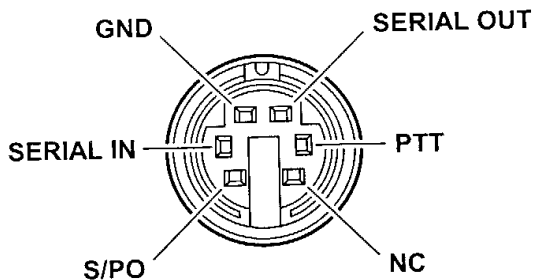

FC-800

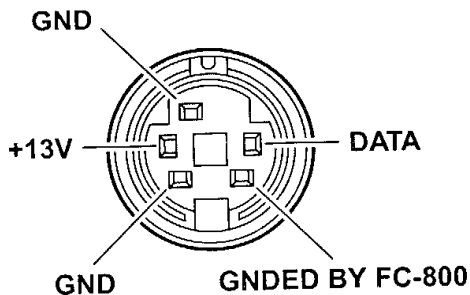

AFSK

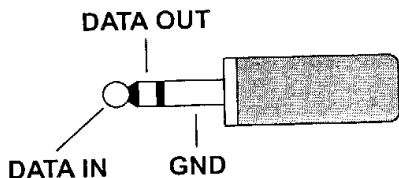

BAND DATA

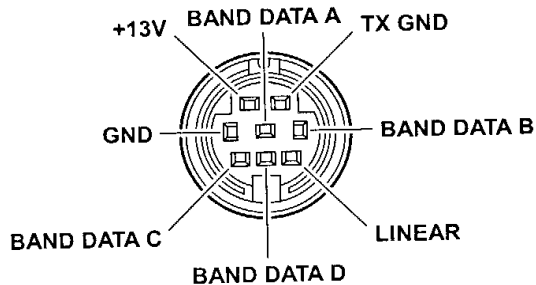

PTT/EXT ALC

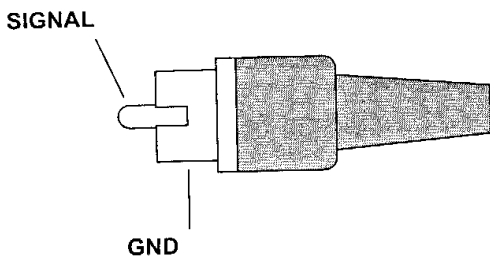

III. Installation

III-1. Safety Precautions

Before proceeding with installation of the System 600 Transceiver, please read and observe all safety and operating instructions. Safety for both installation staff and the customer must be ensured during the configuration and installation process.

1. Power Connections

The power connector for the System 600 must only be connected to a DC source providing 13.5 volts DC ($\pm 10\%$), and capable of at least 20 amperes of current. Do not connect this apparatus to any other DC voltage, and *never* connect the DC power cable to an AC source of any kind. Always observe proper polarity when making DC connections. Our Limited Warranty does not cover damage caused by improper power connections.

Note that other manufacturers may use the same type of DC power connector as does your System 600 Transceiver, but the wiring configuration of the other manufacturer's plug may be different from that specified for your transceiver. Serious damage can be caused if improper DC connections are made.

2. Grounding for Electrical Safety

Connect the rear panel ground lug to a good earth ground. For best performance, such a ground may consist of one or more ground rods connected to the transceiver via a low-inductance cable such as a heavy braided wire (the shield from RG-213 type cable is ideal). The lead-in cable should be as short as possible.

Do not use gas lines as a ground connection!

3. Electrical Shock Prevention

Be certain that all station wiring is properly insulated so as to prevent short circuits which could damage this transceiver and/or accessories connected to it. Be sure to protect power cables from damage due to abrasion by ensuring that they cannot be walked upon nor crushed under rolling chairs, etc. Never route power cables near sharp metallic edges which might cut through protective insulation.

4. Antenna Precautions

Always locate antennas such that they can *never* come in contact with outdoor power lines in the event of a catastrophic antenna support or power line support structure failure. Ground the support structure adequately, so as to dissipate energy absorbed during a lightning strike. Install appropriate lightning arrestors in the antenna lead-in and rotator cable (if used) according to the arrestor's instructions.

In the event of an approaching electrical storm, instruct your customer to disconnect all antenna lead-in, rotator cables, and power cables *completely* from your station **if the storm is not immediately in the vicinity**. Disconnected cables must not touch the case of the System 600 transceiver or accessories, as lightning can easily jump from the cable to the circuitry of the transceiver via the case, causing irreparable damage. If a lightning storm is in progress in the immediate area, the customer should *not* attempt to disconnect the cables, as he or she could be killed instantly if lightning should strike the station's antenna structure or a nearby power line.

If a vertical antenna is utilized, advise your customer that humans and/or pets and farm animals must be kept away both from the radiating element (to prevent electrical shock and RF exposure danger) *and* the ground system (in the event of an electrical storm). The buried radials of a ground-mounted vertical antenna can carry lethal voltages outward from the center of the antenna in the event of a direct lightning strike.

5. Heat and Ventilation

To ensure long life of the components, be certain to provide adequate ventilation around the cabinet of the System 600. The cooling system of the transceiver must be free to draw cool air in from the side of the transceiver and expel warm air from the rear of the transceiver.

Do not install the transceiver on top of another heat-generating device (such as a linear amplifier), and instruct the customer not to place equipment, books, or papers on top of the transceiver. A hard, flat, stable surface such as a desk or computer work station is always best for ensuring stability. Avoid heating vents and window locations that could expose the transceiver to excessive direct sunlight, especially in hot climates.

6. Electromagnetic Compatibility and RF Exposure

If this transceiver is used with or in the vicinity of a computer or computer-driven accessories, you may need to experiment with grounding and/or radio frequency interference (RFI) suppression devices (such as ferrite cores) to minimize interference to communications caused by energy leakage from the computer.

Although there is negligible radio frequency (RF) leakage from the System 600 Transceiver itself, its antenna system should be located as far away from humans and animals as practicable, so as to avoid the possibility of shock due to accidental contact with the antenna or excessive long-term exposure to RF energy.

III-2. Preliminary Inspection

Inspect the transceiver visually immediately upon opening the packing carton. Confirm that all controls and switches work freely, and inspect the cabinet for any damage. Gently shake the transceiver to verify that no internal components have been shaken loose due to rough handling during shipping.

If any evidence of damage is discovered, document it thoroughly and contact the shipping company so as to get instructions regarding the prompt resolution of the damage situation. Be certain to save the shipping carton, especially if there are any punctures or other evidence of damage incurred during shipping; if it is necessary to return the unit to Yaesu for service or replacement, use the original packing materials but put the entire package inside another packing carton, so as to preserve the evidence of shipping damage for insurance purposes.

III-3. Power Requirements and Basic Installation

1. DC Power Connections

The System 600 Transceiver is designed for operation from 13.5 volts DC, negative ground, with the DC source being capable of providing 20 amperes of continuous current.

For mobile applications, the fused (20-A) DC cable supplied with this transceiver may be used for making the power connections. Be absolutely certain to observe the proper polarity when making power connections:

The RED DC power lead connects to the Positive (+) DC terminal; and

The BLACK DC power lead connects to the Negative (-) DC terminal.

To minimize noise pickup, and to provide the best input voltage stability for the transceiver, we recommend that the DC cable be routed directly to the vehicle battery, rather than to the ignition or accessory circuitry. Route the DC cable as far away from ignition cables as possible, and cut off any extra cable (from the battery end) to minimize voltage drop. If the DC cable is not long enough, use #12 AWG (minimum) stranded, insulated wire to extend it. Be absolutely certain to solder the connections at the splice securely, and provide ample insulation for the soldered splice (heat shrink tubing plus black electrical tape work well).

Use the following procedure to connect the DC cable:

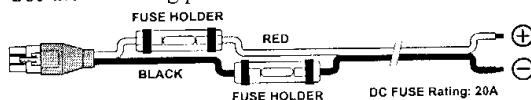

- Before connecting the DC cable to the battery, measure the voltage across the battery terminals with the engine running fast enough to show a charge. If the voltage is above 15 volts, the vehicle's voltage regulator should be adjusted to reduce the charging voltage below 14 volts.
- With the radio end of the cable *disconnected*, connect the **RED** cable lead to the **POSITIVE** battery terminal, and the **BLACK** cable lead to the **NEGATIVE** battery terminal. Make certain that the battery terminal connections are tight, and remember to check them during periodic maintenance inspections of your customer's mobile station.
- Make sure the System 600 transceiver is switched off, and plug the DC cable into the 6-pin Molex jack on the rear panel of the transceiver.

2. Mobile Mounting

The optional MMB-20 Mobile Mounting bracket allows quick insertion and removal of the System 600 transceiver from the vehicle. Complete installation instructions are provided with the bracket.

3. Mobile Antenna Considerations

The System 600 transceiver is designed for use with any antenna system providing a 50 Ω resistive impedance at the desired operating frequency. While minor excursions from the 50 Ω specification are of no consequence, the power amplifier's protection circuitry will begin to reduce the power output if there is more than a 50% divergence from the specified impedance (less than 33 Ω or greater than 75 Ω , corresponding to a Standing Wave Ratio (SWR) of 1.5:1). Compliance with this specification critically depends on the range of frequencies on which operation will take place, and the design of the mobile antenna(s) in use.

If the mobile or marine installation requires wide frequency coverage, the Yaesu YA-007FG or similar

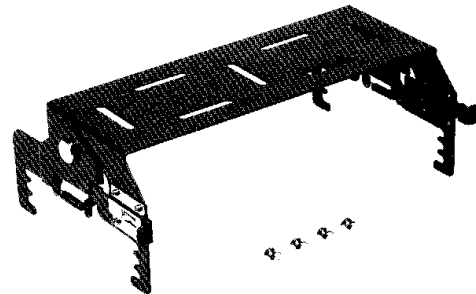

MMB-20 Mobile Mounting Bracket

mobile whip antenna may be used in conjunction with the Yaesu FC-800 External Antenna Tuner. The FC-800 is designed to accommodate a wide variety of whip impedances at the operating frequency, converting these to the desired 50Ω impedance via a sophisticated micro-processor-controlled impedance matching circuit. The FC-800 and System 600 provide memory of antenna matching settings sufficient for all channels on Memory Bank 1. In marine applications, the FC-800 is also ideal for the use with a "backstay" antenna or marine mobile whip.

The FC-800 should be located at or near the base of the antenna, so as to minimize losses and stray radiation. We recommend that the FC-800 and the antenna be

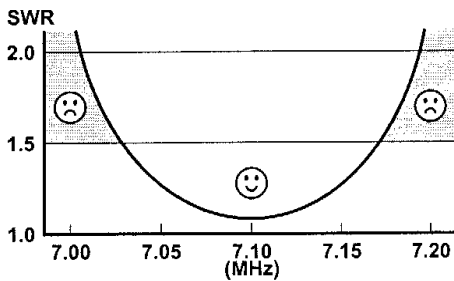

located at least 5 meters apart, if possible, so as to minimize RF feedback caused by direct radiation from the antenna element into the case of the transceiver. Installing the FC-800 in the trunk of a vehicle is satisfactory in most instances.

The short lead-in wire from the whip must be securely bonded both to the FC-800 and the antenna (whip or wire), and the FC-800 must be securely bonded to the vehicle or vessel ground system, which will act as a counterpoise for the FC-800 and antenna radiating element. Be sure to weatherproof all outdoor connections *thoroughly*, especially in maritime environments.

Complete the installation by connecting the RF coaxial cable (Yaesu p/n T9101366) and FC-800 control cable (Yaesu p/n T9101419) as shown in the pictorial below. The coaxial cable and control cable may be extended if the installation situation demands it. An optional 10-meter-long control cable, Part #T9101420-C, is available from Yaesu to replace the standard 5-meter-long control cable supplied with the FC-800. The maximum allowable length for the control cable will critically depend on the diameter of the wires, but lengths of up to 50m should present few problems. Test the system in the shop prior to embarking on installation at the owner's site, so as to uncover any potential problems.

Comprehensive installation instructions are found in the FC-800 Instruction Manual; follow the manufacturer's installation instructions when using a whip an-

tenna other than the YA-007FG. Complete specifications for the FC-800 when used with the System 600 may be found on page 2.

Because short antennas become very inefficient and highly reactive at low frequencies, Yaesu does not recommend mobile installations (utilizing the YA-007FG or other similar-length whip) where operation below approximately 3.5 MHz is required.

In the event of erratic FC-800 operation caused by RF feedback, wrap the control cable around the rim of the "doughnut" toroidal inductor supplied with the FC-800; this inductor should choke off the interfering RF currents, thus restoring normal operation. In some in-

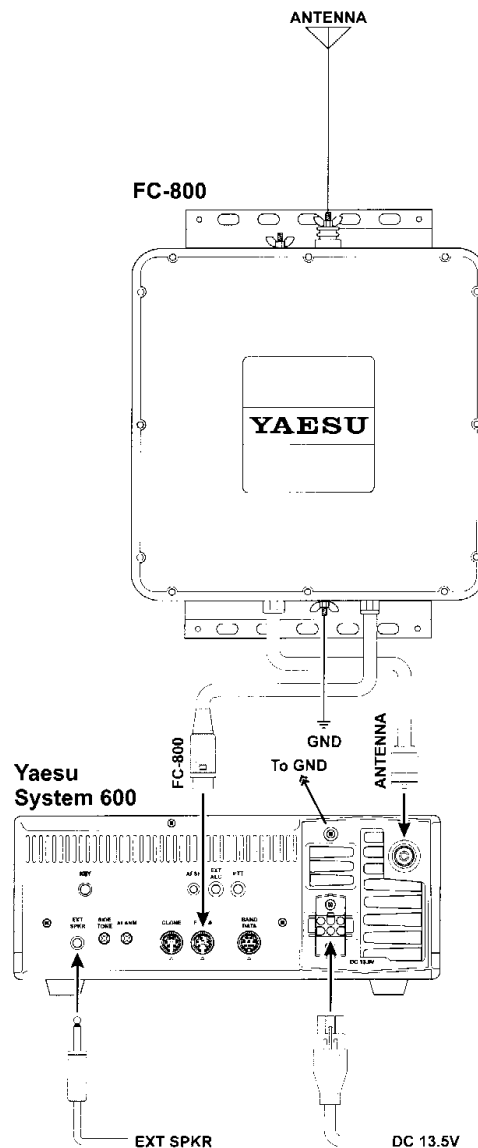

stallations, so-called "common mode" current may flow on the *shield* of the coaxial cable linking the FC-800 and the transceiver, causing similarly erratic operation; if winding the control cable around the toroidal inductor does not restore proper operation, try winding a few turns of the *coaxial cable* around the toroid instead.

4. Mobile Station Grounding

Although satisfactory grounding in most installations will be achieved via the DC cable's negative lead and the antenna system's coaxial cable shield, it may be necessary, in some installations, to provide a direct ground connection to the vehicle's chassis *at the mounting location of the transceiver*. Due to unexpected resonances which may naturally occur in any location, improper communication system performance may result from insufficient grounding. These symptoms may include: RF feedback (resulting in distortion of your transmitted signal), unintended frequency change, blinking or blanking of the frequency display, noise pickup, or loss of memory.

Note that these conditions may occur in *any* communications installation. The System 600 includes extensive filtering designed to minimize the chance of such problems; however, random currents set up by insufficient RF grounding can nullify such filtering. Bonding the rear panel GROUND lug of the System 600 trans-

ceiver to the vehicle or vessel's ground system should clear up any such difficulties.

Yaesu does not recommend the use of "on glass" mobile antennas unless the shield of the coaxial cable is securely grounded near the feedpoint of the antenna. Such antennas frequently are responsible for the ground-related difficulties described above.

5. Base Station Installation

For base station installations, Yaesu recommends the use of the Model FP-800 AC Power Supply. The FP-800 includes a large loudspeaker for the transceiver, as well as its own cooling fan, making the FP-800 ideal for base station applications. The FP-800 is capable of operation from 100~117 volts AC or 200~234 volts AC, depending on the wiring of the FP-800's power transformer taps.

Other models of DC power supplies may be used with the System 600, but the 13.5 V DC voltage, 20-ampere current capability, and DC cable polarity guidelines described previously must be strictly followed.

If the FP-800 is being connected with the System 600 for the first time, *before connecting AC power*, check the label on the rear of the FP-800 which indicates the AC line voltage for which the supply is currently set. If the customer's AC line voltage is outside of this range, the transformer taps inside the power supply must be re-wired, and the AC line fuse in the FP-800 must be

Changing the AC Voltage Range of the FP-800 Power Supply

- Disconnect the AC cable from the rear of the FP-800, and the DC cable from the System 600 transceiver.
- Remove the 8 screws affixing the top cover of the FP-800.
- Unsolder the wires from the transformer, and resolder for the required voltage as indicated below.
- Replace the fuse in the rear panel fuse holder with a fast-blow, 8-Amp fuse (for 100~117 V AC) or a 4-Amp fuse (for 200~234 V AC).
- Check your work carefully, then replace the top cover and its 8 screws. Change the voltage labeling on the rear panel of the FP-800, and replace the AC cord, if necessary.

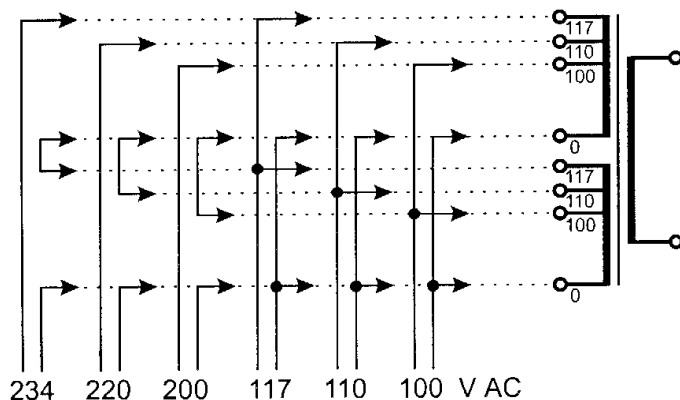

Important!

If you change the AC voltage range you must also change the fuse in the fuse holder on the rear panel of the FP-800. Do not use a slow-blow fuse. Also, make sure to change the labeling of the voltage rating on the rear panel of the FP-800 so as to match the new voltage setting.

Caution!

Permanent damage can result if improper supply voltage is applied to the transceiver. The warranty does not cover damage caused by application of AC, reversed polarity DC, or DC voltage outside of the specified range of 13.5 V \pm 10%.

If using a power supply other than the FP-800, ensure the DC supply connector to the transceiver matches the System 600 wiring configuration. Other manufacturers may utilize power supplies with a physically matched connector that is wired differently; this will cause serious damage to the System 600 transceiver!

changed. Re-wiring of the transformer taps requires a few minutes of soldering, and is easily accomplished by a qualified technician. *Incorrect connections may cause serious damage not covered by the FP-800 or System 600 Limited Warranty.* Note that some customers may use a different voltage in their communications station (e.g. 220 V) than may be used in typical household outlets (e.g. 117 V). Be sure to verify the voltage at the actual site before connecting the FP-800's AC cable to the wall outlet.

Once the AC mains voltage has been verified, confirm that the fuse installed in the FP-800 fuse holder is of the proper rating for the AC mains voltage in use:

AC Line Voltage	Fuse Rating
100~117 V	8 A
200~234 V	4 A

After making certain that both the AC line voltage and fuse rating are correct for your customer's station location, connect the DC lead from the rear of the FP-800 to the DC jack on the rear panel of the System 600 transceiver. Do not plug the power supply AC cord into the wall until all other transceiver interconnections are made.

6. Base Station Antenna Considerations

As with mobile or maritime installations, antenna performance is critical to base station communications system effectiveness. Every effort must be made to ensure that the impedance of the antenna system utilized with the System 600 is as close as practicable to the specified 50 Ω impedance value, and that mechanical and electrical component integrity are maintained at all times.

For wide frequency range applications, Yaesu's YA-30 Broadband Dipole Antenna may be ideal for the customer's communication requirements. Covering an operating frequency range of 3.5~30 MHz, the YA-30 eliminates the need for multiple antennas which might otherwise be required for equivalent frequency coverage.

The type of antenna required for a particular communications distance will vary. A complete discussion of this topic is beyond the range of this manual; however, a few general guidelines follow.

Any antenna to be installed should be free of nearby obstructions which might interfere with its radiation pattern. The antenna, its support structure, and its cables must *never* be installed in such a manner that would allow them to come in contact with power or telephone lines in the event of a catastrophic windstorm or other cause of major failure. An adequate safety margin is *usually* provided by separating power lines from the antenna and its support structure 1.5 times the height of the support *plus* the length of any antenna or guy wires attached to the support *plus* the height of the power line support pole.

When installing a balanced antenna such as a dipole, remember that the System 600 transceiver is designed for use with an (unbalanced) coaxial feedline. Always use a balun or other balancing device so as to ensure proper antenna system performance.

Vertical antennas usually provide excellent coverage beyond about 1000 km (600 miles), but very poor coverage at closer distances. Horizontal antennas are frequently better for shorter distances, but they may require a stout support structure such as a steel lattice tower. The height of the horizontal antenna, and the nature of the ground below it, have a profound impact on the favored launch angle for the main radiation lobe from the antenna at a particular frequency. For example, at 6 MHz a horizontal dipole 10 meters high (33 feet) will provide excellent local coverage out to about 500 km (300 miles); however, at the same frequency the dipole would have to be much higher (perhaps 50 meters or 165 feet)

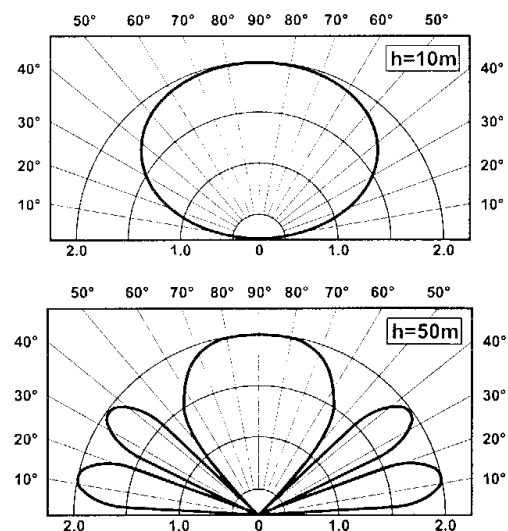

for satisfactory communication over a range of 3000 km (1800 miles). On the other hand, at 25 MHz the same dipole at a height of 10 meters could, ionospheric propagation conditions permitting, be expected to provide outstanding performance over the same 3000 km distance.

When operating below 2 MHz, Yaesu recommends a minimum end-fed wire length of 13 meters (42 feet), or the use of a suitable loading coil or other loading device so as to make the radiating element self-resonant at a frequency not lower than about 5.5 MHz.

Excellent reference texts and computer software for antenna modeling are available for the design and optimization of HF antennas.

Use high-quality 50Ω coaxial cable for the lead-in to the System 600 transceiver. All efforts at providing an efficient antenna system will be wasted if poor quality, lossy coaxial cable is used. Losses in coaxial lines increase as the frequency increases, so a coaxial line with 0.5 dB of loss at 6 MHz may have 2 dB of loss at 25 MHz (1 dB is a just-perceptible decrease in signal strength). As a general rule, smaller-diameter coaxial cables tend to have higher losses than larger-diameter cables, although the precise differences depend critically on the cable construction, materials, and the quality of the connectors used on the cable. See the cable manufacturers' specifications for details.

For reference, the chart below shows approximate loss figures for typically available coaxial cables frequently used in HF installations.

**Loss in dB per 30m (100 feet)
for Selected 50Ω Coaxial Cables**
(Assumes 50Ω Input/Output Terminations)

Cable Type	Loss: 2 MHz	Loss: 15 MHz	Loss: 28 MHz
RG-58A	0.55	1.75	2.60
RG-58 Foam	0.54	1.50	2.00
RG-8X	0.39	1.07	1.85
RG-8A, RG-213	0.27	0.85	1.25
RG-8 Foam	0.22	0.65	0.88
Belden® 9913	0.18	0.50	0.69
RG-17A	0.08	0.30	0.46

Loss figures are approximate; consult cable manufacturers' catalogs for complete specifications.

7. Base Station Grounding

The Yaesu System 600 HF transceiver, like any other HF communications apparatus, requires an effective ground system for maximum electrical safety and best communications effectiveness. A good ground system can contribute to station efficiency in a number of ways.

- It can minimize the possibility of electrical shock to the operator.
- It can minimize RF currents flowing on the shield of the coaxial cable and the chassis of the transceiver which may cause interference to nearby home entertainment devices or laboratory test equipment.
- It can minimize the possibility of erratic transceiver operation caused by RF feedback or improper current flow through logic devices.

An effective earth ground system may take several forms; for a more complete discussion, see an appropriate RF engineering text. The information presented below is intended only as a guideline.

Typically, the ground connection consists of one or more copper-clad steel rods, driven into the ground. If multiple ground rods are used, they should be configured in a "V" configuration, and bonded together at the apex of the V which is nearest the station location. Use a heavy, braided cable (such as the discarded shield from type RG-213 coaxial cable) and strong cable clamps to secure the braided cables to the ground rods. Be sure to weatherproof the connections to ensure many years of reliable service. Use the same type of heavy, braided cable for the connections to the station ground bus (described below).

To minimize RF currents flowing on the shield of coaxial cable, grounding clamps which bond the coaxial shield to a ground rod may be installed directly outside of the station location. Such clamps frequently will "cleanse" a station's coaxial line from troublesome RF currents which can cause television interference or other difficulties.

Inside the station, a common ground bus consisting of a solid copper pipe of at least 25-mm (1-inch) diameter should be used. An alternative ground bus may consist of a wide copper plate (single-sided circuit board material is ideal) secured to the bottom of the operating desk. Grounding connections from individual devices such as transceivers, power supplies, and data communications devices should be made directly to the ground bus using a heavy, braided cable.

Do not make ground connections from one electrical device to another, and thence to the ground bus. This so-called "Daisy Chain" grounding technique may nullify any attempt at effective radio frequency grounding. See the drawings below for examples of proper and improper ground connections.

Inspect the customer's ground system—inside the station as well as outside—on a regular basis as a part of a periodic maintenance procedure so as to ensure maximum performance and safety.

III-4. Accessory Interfacing

III-4A. Accessories & Options

Note: The "Supplied Accessories" may vary from country to country.

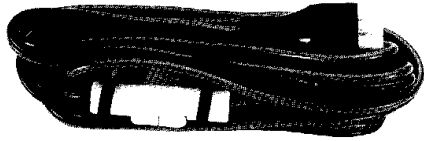

DC Cable (1) p/n T9018320

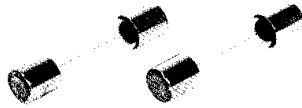

20-Amp Fuse (2) p/n Q0000009

Hand Microphone (1)
p/n MH-31A8J

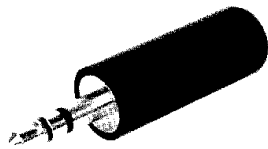
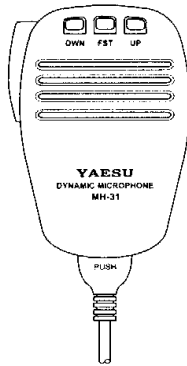

3.5mm Plug (AFSK) (1) p/n P0091046 (Stereo)

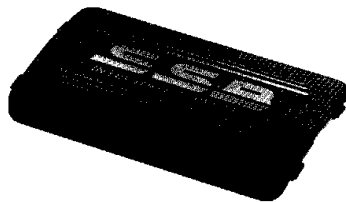

Keypad Cover

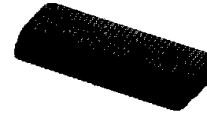

2182/ALARM Cover (1)

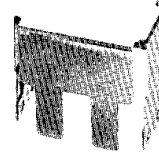

Configuration Key Jig (1)
(Supplied in dealer's Programming Kit only.)

Key Cover Jig (1)

"ITU-Disable" Plug (1) p/n P1090737
(Marine Version)

Optional Plugs/Cables

Item	Utilization	Yaesu Part #
Plugs		
RCA Plug	EXT ALC, PTT	P0090544
3.5-mm Plug (Mono)	KEY, EXT SPKR	P0090034
M plug (PL-259)	Antenna cable	P0090177
6-pin mini DIN	Clone cable	P0090819
8-pin mini DIN	BAND DATA	P0090977
Cables		
RCA-RCA	ALC	T9101296
Band Data	To FL-7000	CT-11 (A05000001)
M - M	RF to Amplifier	T9100980
Clone	Transceiver Cloning	CT-16 (A06720001)
Tuner Control	FC-800 cable	T9101420C (10m length)

Optional Accessories

FC-800 Automatic Antenna Tuner

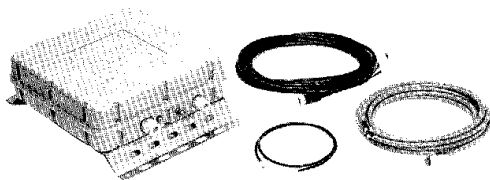

The FC-800 Automatic Antenna Tuner matches a wide variety of impedances, and is designed in a weatherproof housing for mounting near the antenna feed-point (thus avoiding feedline losses due to impedance mismatch). The FC-800 is particularly well suited for Marine installations.

FP-800 AC Power Supply

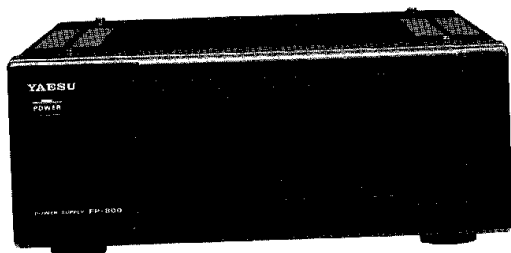

For base station applications, the FP-800 provides a regulated 13.5 V DC supply at up to 20 Amps for powering the System 600 via AC power. The FP-800 may be configured for operation from 100/110/117 V or 200/220/234 V AC.

SP-7 & SP-8 External Speakers

The SP-7 is a high-quality mobile speaker matching the impedance and output requirements of the System 600 transceiver. For base station installations, the SP-8 Speaker includes selectable high-cut and low-cut filters which provide 12 different audio tailoring combinations. Two input terminals are provided for multiple transceivers, with a front panel switch to select between them. A headphone jack is also provided on the front panel to allow the operator to utilize the audio filters when using headphones.

SP-7



SP-8

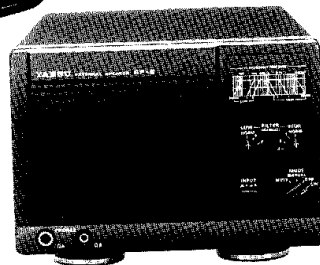

FIF-232C CAT System Interface

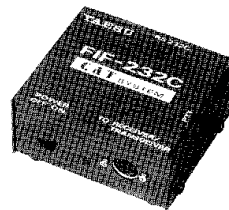

To control the System 600 transceiver from an RS-232C serial port of an external computer, the FIF-232C converts the TTL levels required by the System 600 to the RS-232C levels required by the computer. A cable is included to connect the System 600 to the FIF-232C (the serial cable from the computer to the FIF-232C must be provided separately). The FIF-232C includes its own AC power supply.

TCXO-4 High-Stability Reference Oscillator

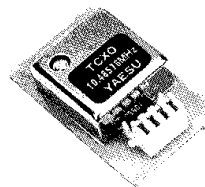

For data or encrypted-network applications, and other environments where extra frequency stability is essential, the TCXO-4 temperature-compensated crystal oscillator is a ± 2 ppm (from 0° to +50° C) replacement for the standard reference oscillator. The TCXO-4 is highly recommended for data communications links, as well as any installations where SELCALL or Encrypted operation is required.

YH-77STA Lightweight Headphones



The YH-77STA headphones are ideal for applications where the use of a loudspeaker is inappropriate. Lightweight and comfortable, the YH-77STA will provide many hours of listening with minimal operator fatigue.

FVP-24 Encryption Unit

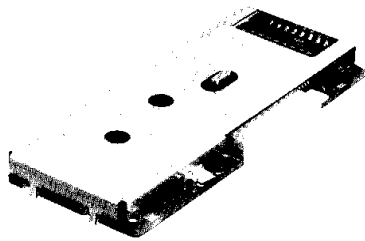

Use the FVP-24 Encryption module for fleet installations where voice privacy is desired. The FVP-24 will *not* function in the Amateur Radio (FT-600) configuration.

MD-100A8X Desktop Microphone



The MD-100A8X is designed to match the electrical and cosmetic features of the System 600, and it includes audio filters to enhance the operator's voice pattern.

IF Crystal Filter Options

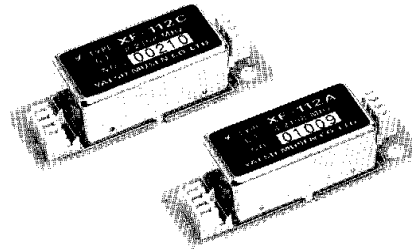

For extra CW selectivity, the YF-112C 500 Hz CW filter may be installed in minutes. No soldering is required.

For enhanced fidelity on shortwave AM broadcasts, the YF-112A 6 kHz AM Filter is highly recommended.

III-4B. Front Panel Interconnections

1. Microphone

The coiled cord from the MH-31_{A8J} Hand Microphone or MD-100_{A8X} Desk Microphone may be connected to the Microphone (D) jack on the front panel by pushing the connector carefully into the jack until a "click" is heard.

To remove the microphone, push on the top of the microphone cable's connector so as to disengage the restraining clip. The microphone cable may then be unplugged.

2. Headphones

Either a monaural or stereo 1/4-inch plug for headphones may be connected to the front panel Headphone jack (H). Plugging headphones into this jack automatically cuts off any audio fed to the internal or external speakers. However, the headphones are *not* affected by the action of the (7) (Speaker Cutoff) key on the Keypad.

III-4C. Rear Panel Interconnections

1. General Accessories (Key, Speaker, Footswitch)

The drawing below shows connections for a CW key, footswitch and the loudspeaker in the FP-800.

2. Terminal Node Controller (For Data Transmission and Reception)

Data terminal installation involving a Terminal Node Controller (TNC) is simple and direct. Follow the drawing and connector pinout pictorials for connection details.

The receive audio level from the System 600 is fixed at approximately 100 mV, which should be compatible with most TNCs on the market. The AFSK transmit audio level must be set by the installer, so as to comply with the System 600's 50% duty cycle specification.

□ For *intermittent* data modes such as AMTOR, the TX Audio level may be set for 100 Watts output from the System 600. So long as the transmit-to-receive time ratio does not exceed 50% on such "burst" type operating modes, this power level is well within the capability of the System 600.

□ For *continuous* data modes such as RTTY, the TX Audio level should be adjusted for a maximum of 50 Watts output, so as not to exceed the heat dissipation capability of the System 600's cooling fan and heat sinking. Consult the Installation Manual for the TNC for instructions on how to adjust the TX Audio input level to the transceiver.

If *only* data communications of a continuous-duty nature are planned, the internal "50/100W" power selection switch may be set to the "50W" position. This will simplify the setup procedure. The TX Audio level from the TNC will still have to be set so as to provide sufficient modulation drive for the transceiver; however, the use of this switch will prevent the possibility of accidental power increase due to unauthorized adjustment of the TX Audio level.

Because frequency accuracy is very important in most data communications installations, we highly recommend that the optional TCXO-4 Temperature Compensated Crystal Reference Oscillator be installed in all transceivers used for data transmission and reception. Without the TCXO-4, it is unlikely that an unattended HF Packet station, for example, will be able to stay connected to the communication network, because frequency tolerances of ± 20 Hz are usually required.

AFSK Jack Wiring for Packet and WeatherFax

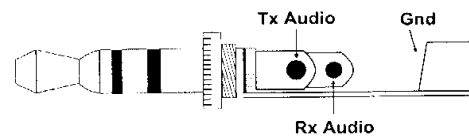

(Also connect the terminal's tx control line to the PTT jack)

General Accessories

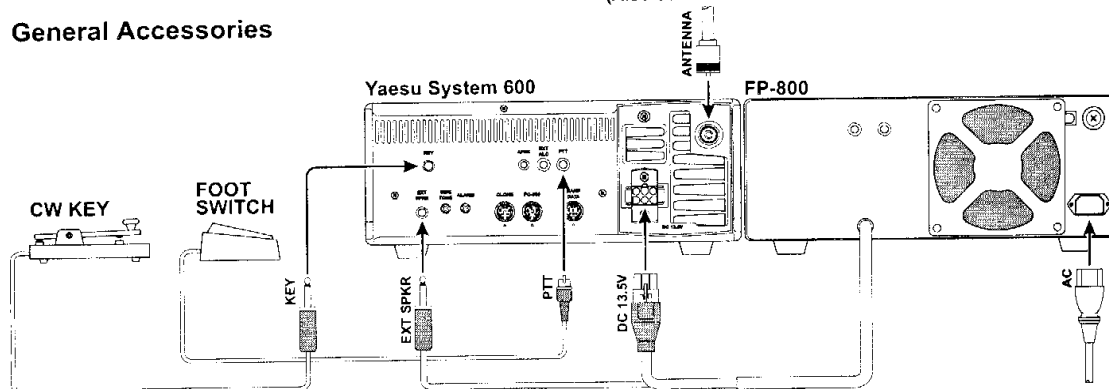

3. WeatherFax Demodulator

Connect the ring contact on the AFSK jack (page 8) to the demodulator input.

4. Linear Amplifiers

Linear amplifier interfacing requires three interconnection cables.

- A 50Ω coaxial cable with PL-259 connectors on each end (Yaesu Part #T9100980) carries RF drive from the System 600 to the amplifier.
- A (user- or dealer-supplied) multi-wire control cable provides transmit/receive control as well as transmitter/amplifier switch sequencing (if required).

If the transmit/receive relay in the amplifier utilizes a DC coil voltage of less than +150 V (positive voltage only!), and draws less than 600 mA of current when engaged, the relay control lead may be connected to pin 2 (TX GND) of the System 600 **BAND DATA** mini-DIN connector, using pin 3 (Ground) for the shield. When the System 600 is placed in the transmit mode by closure of the PTT switching line, pin 2 of the **BAND DATA** jack will be closed to ground (pin 3), thus placing the amplifier's transmit/receive relay in the "transmit" position. Releasing the PTT switch on the System 600 opens the connection between pin 2 and pin 3, and the amplifier will return to the "receive" condition. Refer to the inset in the diagram on the next page for schematic details.

If the transmit/receive relay in the amplifier utilizes a DC coil voltage greater than +150 V, current greater than 600 mA, or an AC voltage of any magnitude, then the relay control line *must not* be connected directly to

the **BAND DATA** connector. Instead, a suitable mechanical relay interface to the amplifier should be constructed. The Yaesu FRB-757, re-wired to interface to the **BAND DATA** pin requirements, is suitable for this purpose.

If the proposed amplifier provides an "exciter-enable" output line, it may be connected to pin 8 (LINEAR) of the **BAND DATA** connector.

This line must be held high (+5 to +15 V DC) to inhibit transmission until the amplifier is ready for excitation (usually, when the amplifier's control microprocessor determines that the relays in the amplifier are properly seated). Generally, the use of this pin is not required.

- A shielded audio or 50Ω miniature coaxial cable with RCA connectors on each end (Yaesu part #T9101296) carries ALC feedback voltage from the amplifier to the transceiver, allowing the amplifier to control the drive level supplied by the System 600 to the amplifier. The ALC voltage range is 0 V (at zero drive) to -4 V DC (at maximum amplifier power output).

ALC control of the System 600 only works properly when the control voltage generated by the amplifier is derived based on the total output power from the amplifier. That is, when the amplifier has reached its rated output power (e.g. 1000 W), the amplifier then generates ALC voltage to prevent the System 600 from providing additional (unnecessary) drive power. Some amplifiers, however, generate ALC voltage based on other parameters (such as PA tube grid current), and these ALC derivation techniques, which may serve to protect the

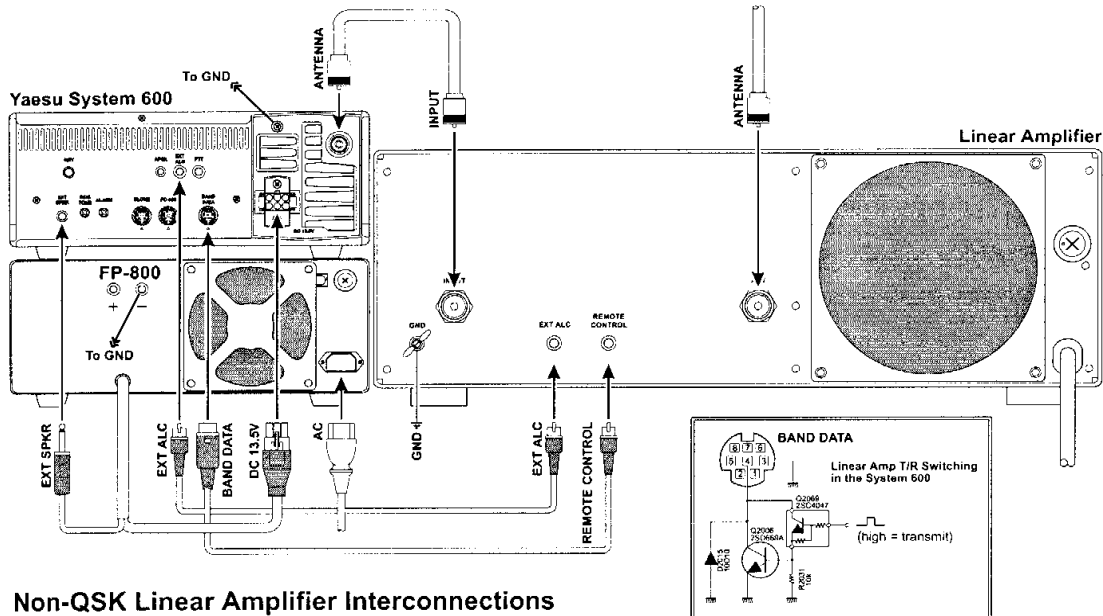

Non-QSK Linear Amplifier Interconnections

Location of VR1016 and 50/100W Switch

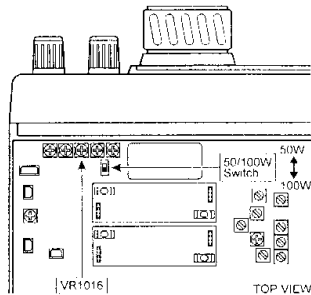

amplifier from damage caused by mis-tuning, will not work correctly with the System 600.

If the ALC system of your amplifier is incompatible with the System 600 transceiver, the maximum power output may be adjusted by setting the internal "50/100W" switch to "50," and adjusting potentiometer VR1016 for the desired drive level. Note: this will limit the transceiver's power output when the amplifier is off, as well.

Important Note!

The transmit/receive control transistor used for interfacing to a linear amplifier has a total dissipation rating of about 7.5 watts (voltage x current). Therefore, an amplifier control relay coil which draws 600 mA at +150 V DC will exceed the transistor's ratings and may cause damage. The above voltage and current specifications are maximum ratings. Do not exceed either individual specification, and do not exceed the total dissipation rating of the transistor (100 mA at 75 V DC, for example).

Most amplifier control relay coils require much less switching capability (typically, +12 V DC at 50-100 mA maximum), and the switching transistor in the System 600 will easily accommodate such amplifiers.

III-4D. Installation of Internal Accessories

1. Cover Removal

- Turn the transceiver off, and disconnect all cables and accessories.
- Remove the five screws holding the top panel assembly in place: two from each side and one from the rear face at the top. Carefully slide the top cover backward and upward to remove it.
- If installing crystal filters, proceed directly to the crystal filter installation procedure below.
- To remove the bottom cover (for TCXO-4 or FVP-24 installation), turn the transceiver upside-down on the work surface. Remove the six screws affixing the bottom cover to the chassis, and carefully remove the bottom cover from the transceiver.

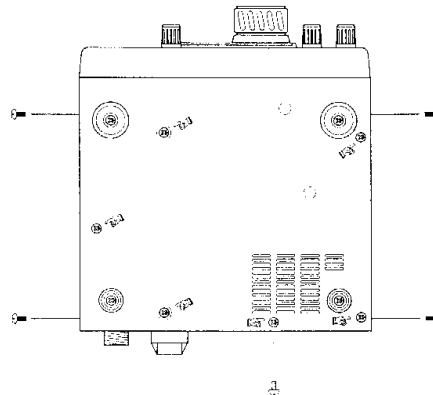

2. TCXO-4 High-Stability Master Oscillator

The ± 2 ppm TCXO-4 option can be installed as a replacement for the standard ± 10 ppm reference oscillator in the System 600.

- After removal of top and bottom covers, turn the transceiver upside-down on the work surface.
- Locate the original reference oscillator assembly (see Figure 1). Using a set of needle-nose pliers, gently squeeze the plastic retaining clip (located on the end of the reference oscillator board nearest the front of the transceiver) so as to allow the reference oscillator board to be pried gently upward. Rock the board back and forth so as to loosen and remove it completely.
- Carefully align the pins of the TCXO-4 into the Molex socket, and push the TCXO-4 onto the con-

Figure 1. TCXO-4 Location

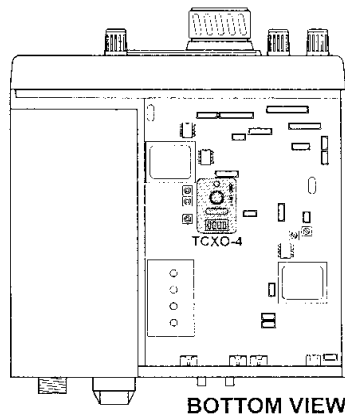

necter until the plastic retaining clip at the front of the TCXO-4 clicks into its "locked" position.

- Replace the bottom cover with its six screws.
- Replace the top cover: first fit the screw on the rear panel, then fit the other four screws.
- Save the original master oscillator module for possible emergency use in the unlikely event of a reference oscillator failure in the future.

3. Crystal Filter Installation

- Only the top cover need be removed for installation of the optional crystal filter(s).
- Referring to Figure 2, determine the location of the filter(s) you are installing. The YF-112C should be installed in the slot nearest to the front panel of the transceiver, while the YF-112A should be installed in the slot nearest the rear of the transceiver.

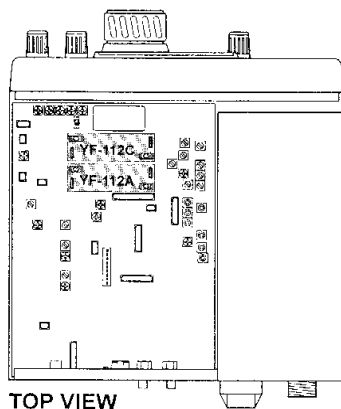
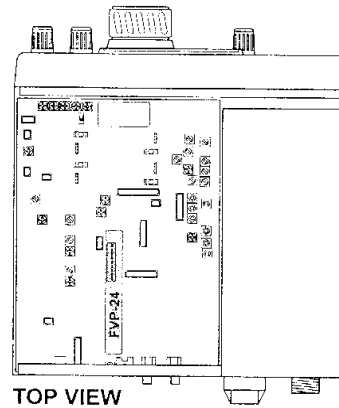

Figure 2. Crystal Filter Locations

Figure 3. FVP-24 Location



- Carefully align the pins on the Main Unit with the socket on the filter module, and then push the filter module downward onto the Main Unit. Gently push downward until the two plastic retaining clips click into their "locked" position.
- The filter module contains wiring which advises the main microprocessor that the optional filter has been installed. No other wiring changes or diode cuts are required.
- Replace the top cover: first fit the screw on the rear panel, then fit the other four screws.

4. FVP-24 Encryption Module

- Only the top cover need be removed for installation of the FVP-24.
- Refer to Figure 3, and locate the pin connector for the Encryption module (J1009). The Main Unit is printed **OPTION SCMB UNIT** in the location where the FVP-24 is to be installed.
- Carefully align the Molex connector on the FVP-24 with the pins on the Main Unit, and gently push the FVP-24 onto the pins.
- On the FVP-24, select the "FIX" mode (Switch #1 Off) or the "ROLLING" mode (Switch #1 On), according to the requirements of the communication network being installed.
- Now set the Encryption Codes using the DIP switches. Switches 2-6 are used for the Rolling mode, and switches 6-0 are used for the Fix mode.
- Replace the top cover: first fit the screw on the rear panel, then fit the other four screws.

Comparison of Encryption Modes

The two Encryption modes provided in the FVP-24 each have advantages and disadvantages. A comparison of the two modes follows.

Fix Mode

Better performance under marginal signal conditions or high noise.

Frequency tolerance is less stringent than Rolling mode.

Communication security not as good as Rolling mode.

Rolling Mode

Communication security higher than Fix mode.

Frequency tolerance is very tight (± 50 Hz maximum).

Distortion of voice signal slightly higher than Fix mode.

Not recommended during marginal signal conditions or high noise.

IV: Configuration and Programming

IV-1. Basic Steps

Preparation of a System 600 Transceiver installation involves five basic steps:

1. Insertion of the "General Coverage" Configuration Key, used for programming of memory channels (if needed).
2. Programming of any needed customer memory channels for the customer's requirements.
3. Insertion of the Configuration Key appropriate for the user's ultimate application, and installation of any applicable covers preventing user access to illegal or unnecessary controls and switches, as well as any appropriate labels.
4. Verification of performance using the user's Configuration Key.
5. Cloning of data to other transceivers, if a fleet is being configured.

IV-2. Configuration Key Information

Four Configuration Keys are available for the System 600 HF Transceiver line. They are:

- The "LMR" key, used for Land Mobile Radio installations.
- The "Marine" key, used for Marine service installations.
- The "•" key, used for programming by the dealer or installer; also used for governmental or other "General Coverage" applications. This is the key referred to as the "General Coverage" key.
- The "FT-600" key, for Amateur Radio installations. This key, and all Amateur Radio-related installation and programming discussions, are found in the System 600 Operating Manual, and are not repeated herein.

A Configuration Key may be inserted into the front panel slot by hand. Be certain to observe the proper

polarity of the Configuration Key: the *single* alignment ridge is on top, and the *pair* of alignment ridges goes on the bottom.

To *remove* or *change* a Configuration Key, use the System 600 Configuration Key Jig. Then follow these simple steps:

- Hold the Configuration Key Jig such that the *single* alignment shaft is on top.
- Carefully align the Configuration Key Jig so that its four sides will slip into the Configuration Key slot (on the front panel of the transceiver) *just outside* the currently-inserted Configuration Key.
- Carefully push the Configuration Key Jig inward until you feel a slight "click" as the Jig locks onto the Configuration Key.
- Pull the Configuration Key Jig out, bringing the Configuration Key with it.

A different Configuration Key may now be inserted.

Important Notice Regarding Configuration Keys

The Yaesu System 600 HF Transceiver System is designed for a wide range of applications in world markets. As such, it can be configured for a number of different operating and programming techniques, some of which may not be necessary, desirable, or legal for use by some licensees.

It is the responsibility of you, as the Dealer, to respect and maintain the security of Configuration Keys, so as to prevent the use of the System 600 transceiver in a service for which it may not be authorized in your market. The unauthorized release of a Configuration Key to any person outside of Yaesu's authorized Sales and Service network is expressly prohibited by Yaesu, and may endanger your status as a Yaesu Dealer.

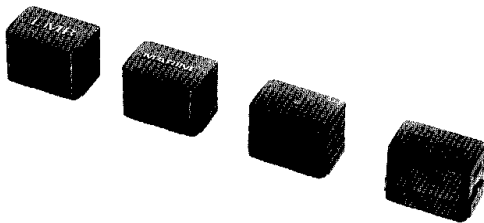

Configuration Key

IV-2A. Marine "ITU-Disable" Jumper

A special jumper plug, Yaesu Part #P1090737 on the Main Unit, allows the "Marine" version to include or exclude the "ITU Marine Channel" memory bank.

The "ITU-Disable" plug must be *installed* if the ITU Marine Channel memory bank is to be *excluded*. For most installations, however, this plug should be left out of the transceiver.

ITU Disable Plug Location

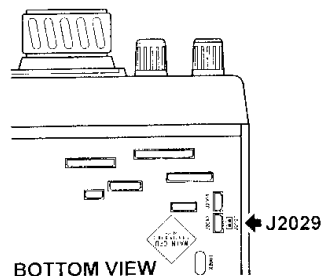

IV-3. Memory Channel Programming

Four Memory Banks, each capable of storing up to 25 memory channels, are provided, yielding a total of 100 available memory channels. Programming is easily accomplished using the keypad. Before memory channel programming can be attempted, it is important to understand the (simple) procedures used in frequency determination on the System 600.

IV-3A. Frequency Determination

On the front panel LCD display, frequency, mode, memory channel numbers, and Alpha-Numeric labels (denoted "Alpha Tags" in this manual) can all be displayed at one time or another, depending on how the transceiver is configured. These instructions will assume that the dealer or installer is turning on a System 600 transceiver for the first time; if the unit has already been programmed, some displays may be different as to the numbers or letters observed, although the *functions* will be the same).

Initial Setup

- Place the "•" (General Coverage) Configuration Key into the designated slot on the front panel of the transceiver.
- Preset the Volume and Squelch controls fully counter-clockwise, and preset the Clarifier control to its center (detent) position.
- Connect a Dummy Load (or antenna) to the rear panel Antenna jack, and the microphone to the front panel M jack.
- Turn the transceiver On. The LCD will indicate [6.000.0] (MHz) as the operating frequency, using the VFO method of frequency control, the J3E (USB) operating mode, and with 100 Hz (per step) selected as the synthesizer step size.

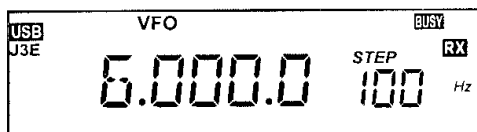

- Adjust the Volume for a comfortable listening level, if you have an antenna connected. You may use the Main Dial to tune around in the vicinity of 6.000.0 MHz. See the "Operation" section for more information regarding VFO operation.
- Push the **M** key once. The main frequency display area will go *blank*, and the 100 Hz indication will be replaced by 1-01 CH, indicating Memory Channel 1-01, and the VFO icon will have been replaced by the MEM icon, indicating Memory operation.

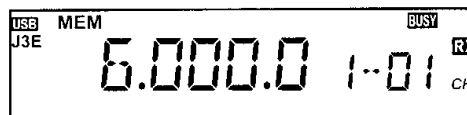

The System 600's 100 memory channels, as mentioned earlier, are arranged in four banks of 25 channels each. Here is how to navigate through the memory channels and other frequency determination options available on the System 600:

Navigation

- From Memory Channel 1-01, rotate the Main Dial clockwise one click. You will observe that the 1-01 CH Memory Channel indication has changed to 1-02 CH, indicating that you have selected Memory Channel 1-02. Further clockwise rotation of the Main Dial will step the memory channel selection process through the 25 channels available in Memory Bank 1. At Memory Channel 1-25, further clockwise rotation of the Main Dial returns the display to Memory Channel 1-01.
- 1-1 → 1-2 → 1-3 → 1-4 → ... 1-24 → 1-25 → 1-1...
- Now press the **M** key once more. The display will now show 2-01 CH, indicating Memory Channel #1 on Memory Bank #2. Again, you may rotate the Main Dial to select any of the 25 channels available in Memory Bank #2.
- Pressing the **M** key again will bring you to Memory Bank 3 (Memory Channel 3-01), and yet another press of the **M** key will select Memory Bank 4 (Memory Channel 4-01).
- From Memory Bank 4, press the **M** key again. The display will indicate a frequency of 4.357.0 MHz, a channel indication of 4-01, and the MEM icon will have been replaced by the ITU icon. This display indicates that the transceiver has been placed in the special bank of ITU-assigned Marine channels (listed on page 30).

Rotation of the Main Dial will step the transceiver through these pre-set memories. These memory slots are

fixed, and neither the operating frequency, mode, nor channel number can be changed, nor can an Alpha Tag be programmed onto a Marine channel.

Remember that, if the "ITU-Disable" Marine jumper is installed, this bank of ITU Marine Channels will be disabled and not included in the rotation of frequency-determining modes.

- From the "ITU" mode, one more push of the **M** key will return the transceiver to the "VFO" mode, where the transceiver initially came up. Now that you understand navigation through the various frequency-determining banks of the System 600, channel programming may commence.

IV-3B. Memory Channel Storage

For Simplex Memory Channels (transmit/receive on same frequency):

- Press the **M** key, as needed, to select the desired Memory Bank.
- Once the desired Memory Bank is selected, rotate the Main Dial to select the desired Memory Channel within that bank. If you choose a channel on which data is already stored, you will *overwrite* the data previously stored.
- Press the **MEM** (Memory Write) key momentarily; then enter six digits of the desired operating frequency (the 10s of Hz digit cannot be entered, as frequency resolution during memory operation is to the nearest 100 Hz step).
- Press the **ENT** key. The **TX** icon will blink. If the displayed frequency is the same as the *receive* frequency just stored, press the **ENT** key again (see the note following "Semi-Duplex Channels" below).
- Now press the **MODE** key, as needed, to select the desired operating mode (J3E USB/LSB, J2B, A1A, or H3E).
- Now press *and hold in* the **ENT** key for 0.5 second to lock the frequency and mode into memory.
- Repeat this procedure for all memory channels desired. Note that Memory Channel 1-01 is used for "Dual Watch" operation, so it is advised that you not use this channel except for the Dual Watch Priority Channel. See the Operating Manual for information on Dual Watch operation.
- To *delete* channel information from a memory, follow the above procedure for *storage*, but enter all *Zeros* for the frequency (e.g., 000000), then press **ENT**. The memory data for that channel will then be erased.

If you make a mistake during memory entry, rotate the Main Dial so as to cause the erroneous digit of the

frequency to blink; now, push the *correct* number on the keypad, and continue with the remainder of the memory frequency entry process.

For Semi-Duplex Channels (different transmit/receive frequencies):

- Press the **M** key, as needed, to select the desired Memory Bank.
- Once the desired Memory Bank is selected, rotate the Main Dial to select the desired Memory Channel within that bank. If you choose a channel on which data is already stored, you will *overwrite* the data previously stored.
- Press the **MEM** (Memory Write) key momentarily. The **RX** icon will blink, indicating that you are ready to program the *receive* frequency. Now enter all six digits of the desired receive frequency (the 10s of Hz digit cannot be entered, as frequency resolution during memory operation is to the nearest 100 Hz step).
- Press the **ENT** key momentarily. The **TX** icon will now blink, indicating that you are ready to program the separate *transmit* frequency.
- Now enter all six digits of the desired transmit frequency.
- Press the **ENT** key momentarily.
- The mode icon will now be blinking. Press the **MODE** key, as needed, to select the desired operating mode.
- Now press *and hold in* the **ENT** key for 0.5 second to lock the split frequency pair into memory.

Note Regarding Memory Programming

If you have programmed a split pair of frequencies into a memory, remember that **both** the receive **and** transmit frequencies must be entered if you over-write that memory slot, even if it is a "simplex" situation. Just re-enter the receive frequency when the **TX** icon is blinking, as described previously, to ensure that storage of an unwanted split frequency pair does not occur.

IV-3C. Alpha Tag Storage

An Alpha-Numeric label, referred to as an "Alpha Tag" in this manual, may be added to the contents of a memory location. Such an "Alpha Tag" may be easier or more intuitive for the operator to utilize when recalling memories; frequency information alone can be especially confusing when a large number of memories are stored.

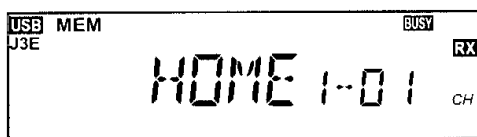

Storage of an Alpha Tag into a memory location is simple to perform. Use the following procedure:

- Select the Memory Bank and Memory Channel number on which you desire to add an Alpha Tag.
- Press the **6** key to select the Alpha Tag method of memory channel display. If an Alpha Tag has been previously stored, it will be displayed now. If *no* Alpha Tag has been stored, only the memory channel number will be displayed (e.g. 1-05). You may want to double-check the frequency data at this point, to be certain you have selected the correct channel.
- Press the **ENT** key to enter the Alpha Tag Entry mode. The first digit location on the left side of the display will begin blinking.
- Select the first character of the proposed Alpha Tag by rotating the Main Dial.
- When the first digit has been chosen, press the **ENT** key. The second digit of the Alpha Tag will now blink.
- Repeat the entry procedure of rotating the Main Dial to select the desired character, then pressing the **ENT** key, for up to six digits of the Alpha Tag.
- To complete the entry and return to normal operation, push **and hold in** the **ENT** key for 0.5 second. This may be done at any point in the Alpha Tag Entry process.

If you make a mistake, just re-write the Alpha Tag from the beginning.

Useful tips: the "u" character is used to program a **blank space**, which may be useful on some Alpha Tags. Also, use the "Zero" figure when an upper-case "O" ("Oh") is desired, as the "O" figure in the Alpha Tag character set is *lower case* (o).

IV-3D. SELCALL ID Code Programming (J3E Mode Only)

The Yaesu System 600 Selective Calling feature may be useful in some fleet installations. It allows a dispatcher to page a particular station, group of stations, or the entire fleet by selection of an appropriate SELCALL code. Programming of SELCALL codes is easily accomplished; use the following procedure:

- Turn the transceiver Off.
- Push **and hold in** the **S** key while you turn the transceiver On. The display will show **R# ID** followed by four digits (or four hyphens, if this is the first time a receive SELCALL code is being programmed).

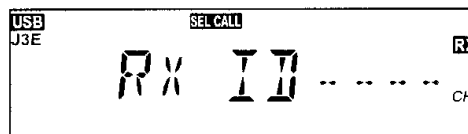

- Press the keypad's **ENT** key momentarily. The first digit location of the RX ID code will blink. Now key in a four-digit ID code (Note: you may not use the "0" (Zero) figure for *any* digit in a receive SELCALL code). Complete the procedure by pressing **and holding in** for 0.5 second the **ENT** key after all four digits have been entered. The display will revert to the operating frequency.
- If you intend to program a transmit SELCALL code, proceed to the next paragraph. If you are *not* programming a transmit SELCALL code, turn the transceiver Off, then back On, to resume normal operation.
- To program a *transmit* SELCALL code, push the **S** key momentarily. The RX ID code will appear. Now rotate the Main Dial clockwise one click to display **TX ID**, the first of five different transmit SELCALL codes available. As on receive, press the keypad's **ENT** key momentarily; the first digit of the TX ID 1 code will blink. Enter the four-digit code of the station you wish to page, then press **and hold in** the **ENT** key for 0.5 second.
- The **0** (Zero) key is available when programming *transmit* ID SELCALL codes; it activates a "Group Page" mode. Placing the "0" figure as the *first* digit

in a TX ID code will cause *all* units to be paged whose *next three digits are the same as the last three digits of the dispatcher's TX ID code*. For example, if the dispatcher sends a TX ID code of "0555," then any fleet units with "x555" in the RX ID code (e.g. "1555," "2555," etc.) will be paged. If the dispatcher sends a TX ID code of "5055," then any fleet units with "5x55" in the RX ID code (e.g. "5155," "5255," etc.) will be paged. If *all zeroes* are sent as a TX ID code by the dispatcher, then *all* stations will be paged.

Do not use "0" as a "routine" digit in a TX ID code, since the "0" cannot be entered as an RX ID code by another unit; the use of the "0" figure is reserved for Group Paging.

- Rotate the Main Dial one click clockwise to display TX ID 2, and you may repeat this procedure for up to five TX ID SELCALL codes. If your fleet regularly utilizes SELCALL, it may be a good idea to store "0000" as a universal fleet paging code in one TX ID memory, so as to allow paging of all units by the dispatcher.
- When all SELCALL codes are stored in memory, turn the transceiver Off, then On again, to resume normal operation.

Note that the TX ID codes may be changed at any time by pressing the **S** key momentarily, rotating the Main Dial to display the desired TX ID code, and completing the above entry procedure. The *RX ID* code, however, can only be changed by first switching the transceiver Off, then pushing the **S** key and holding it in while turning the transceiver On. This is a safety feature designed to help prevent inadvertent changing of the important receive SELCALL identification code.

To check the proper functioning of the SELCALL system, use the following procedure:

- To activate the SELCALL system, push the front panel **S** button momentarily. The (incoming) "RX ID" selective calling code will be displayed. If the "RX ID" code is correct, push *and hold in* the **S** button for 0.5 second to place the transceiver in the "SELCALL" receiving mode. If the code is *not* correct, re-program it.
- In the SELCALL receiving mode, the receiver will be muted, and the **SELCALL** icon will be illuminated. When a call to the selected "RX ID" code is received, a bell alarm will be heard and the **SELCALL** icon will blink. Push the PTT switch momentarily to cancel SELCALL, then push the PTT and speak into the microphone in the usual fashion to reply to the SELCALL page.

- Once you have transmitted following reception of a SELCALL page, SELCALL must be *re-activated* by the operator; otherwise, normal receive (un-muted) operation will occur. Push the **S** key twice, as above, to re-activate SELCALL operation.
- The volume level of the receive SELCALL alarm bell may be adjusted via the rear panel **SIDETONE** potentiometer.

If you have programmed a *transmit* SELCALL page code (any of "TX ID 1" through "TX ID 5") into the transceiver you are setting up, the transmit SELCALL signal may be sent via the following procedure:

- Press the **S** button to display the "RX ID" code.
- Rotate the Main Dial to select the desired "TX ID" code for the station(s) to be paged.
- Press the **S** button for 0.5 second to transmit the page.

Do *not* close the PTT switch; pushing the **S** key will automatically engage the transmitter. To repeat the page, push **S** once *momentarily* and then again push **S** for 0.5 second.

- To revert to the *receive* SELCALL mode, push **S** (the TX ID code will be displayed), then rotate the Main Dial to display the RX ID code. Now push *and hold in* the **S** key for 0.5 second to re-enable receive SELCALL operation.

IV-4. Performance Verification: Transceiver

Once programming has been completed, verify performance using the transceiver as it is to be utilized by the operator.

- Turn the transceiver Off.
- Connect a dummy load and wattmeter to the rear panel Antenna jack.
- Remove the **•** key from the transceiver under test, using the Configuration Key Tool, unless the user is authorized to use the General Coverage key.
- Install the "LMR" or "Marine" key, as appropriate.
- Turn the transceiver On.
- Conduct a power output check on each installed channel. The J3E power output should be 100 watts when you whistle into the microphone. If no CW key is connected, closing the microphone PTT switch in the A1A mode will cause a full-power carrier to be transmitted.
- If any A1A channels are installed, plug a telegraph key into the rear panel **KEY** jack, and verify proper

CW operation by closing the key contacts. The transmitter should be activated, the Sidetone should be audible, and full power output should be obtained. Set the Sidetone level via its adjustment access hole on the rear panel of the transceiver.

Marine Transceivers Only:

Verify performance of the Emergency Channel as follows:

- First, press the **2182** key on the front panel. The display should indicate operation on 2.182 MHz, with a special channel designator of **E--H**. The **H3E** mode icon should also be activated.
- Next, press **ALARM**. After one second, the audible alarm bell should be heard coming from the speaker.
- Press **ALARM** again to stop the alarm bell.
- Finally, press both **ALARM** and **2182** *simultaneously*.
- Check to be sure that the transmitter is activated, and listen on a monitor receiver to be certain that the alarm signal is being transmitted by the transceiver under test.
- Now disconnect the dummy load and wattmeter, and connect a calibrated signal generator in their place.
- Conduct a receive sensitivity test. A Signal-To-Noise ratio of at least 10 dB or better should be attained when a test signal of 0.25 mV is injected in the J3E, J2B, or A1A modes; on A3E channels, 10 dB Signal-To-Noise ratio should be attained on a 1 mV signal modulated 30% by a 400 Hz tone.

Remember to install any applicable Key Covers to the transceiver prior to delivery to the customer. If the transceiver is a "Marine" configuration, be certain to install the **2182/ALARM** label which replaces the **▼/▲** label to the right of the Main Tuning Dial.

IV-5. Performance Verification: FC-800

When the Yaesu FC-800 External Antenna Tuner is installed, it must be activated on each channel in use. While transmitting, you should see the bargraph illuminate fully to the right side (to the **T** icon). This indicates that a satisfactory match has been achieved. Use the following procedure to verify FC-800 performance.

- Be certain that all connections to the FC-800 have been properly made.
- With the appropriate channel selected via the Main Dial, press the **TUNER** key on the keypad. The **TUNER** icon on the Main Display will blink, and the System 600 will transmit for a short time. Thereafter, the transceiver will return to the receive mode, and the **TUNER**

icon will now be illuminated constantly. The 'chattering' of the FC-800's relays is entirely normal, as the tuner's microprocessor is selecting the optimum combination of coil(s) and capacitor(s) for the frequency and antenna under test.

Once the Antenna Tuner is activated on a particular channel or channels, it will remain active unless you turn it off by pushing the **TUNER** key again. If this is done, and an improperly-tuned antenna is connected to the rear panel Antenna jack, the power output from the transceiver will be suppressed by the power amplifier protection circuitry.

As a short-cut to tuning each antenna individually, you may use a special procedure for tuning *all* channels stored in Memory Bank 1 (Memory Channels 1-01 through 1-25). Push the **F** key, then (within five seconds) push the **TUNER** key. The Main Display will indicate **TUNING** and the transmitter will be activated. When tuning of all channels on Memory Bank 1 is completed, the transceiver will revert to the receive mode. Note that this Automatic Memory Bank Tuning feature may take up to three minutes to complete. During this time, no transceiver operations may take place. Do not turn the transceiver off during Automatic Memory Bank Antenna Tuning.

The FC-800's microprocessor-based circuitry includes memory sufficient to retain 31 antenna tuning settings in memory. This will greatly reduce frequency change time. If more than 31 operating channels are utilized that are widely removed in frequency, the new tuning settings will be over-written onto tuner memory slot #31.

Note that the FC-800's tuner memory system and tuning range are designed to allow a frequency excursion of up to 100 kHz without *automatically* causing a re-tuning to occur. If you are installing a unit with several channels within a 100-kHz range, only one tuner memory slot should be required, unless the antenna displays high reactance (and, consequently, a very narrow range of approximate resonance after tuning by the FC-800).

Important Note!

*If the FC-800 is unable to attain a satisfactory impedance match to the antenna, tuning will cease and the **TUNER** icon will cease to be illuminated. Under these conditions, you will have to change the antenna's length or otherwise modify the antenna for proper performance. See the FC-800 Operating Manual and for further information regarding antenna configuration.*

IV-6. Cloning

If a fleet of transceivers is to be installed, all of which use identical channels, Alpha Tags, and other such parameters, use the handy Clone feature to speed your installation work.

- Turn both transceivers Off. Now push *and hold in* the **[4]** key on each radio while turning the transceivers On. Release the **[4]** key after the transceiver comes on displaying **CLONE** on the LCD.
- Connect the (optional) CT-16 Cloning Cable between the **CLONE** jacks of the source radio and the target radio.
- On the target radio, press the **[3]** key to receive the data. **SENDING** will appear on the display. On the source radio, press the **[4]** key to send the data. **SENDING** will blink on the display.
- When data transfer is complete, a "Beep" will sound, and the **CLONE** indication will return to the display.

If a problem has occurred during data transfer, **ERROR** will be displayed.

Check your cables, and try again if this happens.

- Turn the transceivers Off, then On again, to resume normal operation.

Remember that, if one transceiver is a *dispatch center* transceiver, its SELCALL codes may be different from those of the fleet's transceivers, and it may be desirable to program that unit separately.

IV-7. Final Fleet Performance Verification

Once Cloning is completed, you may verify fleet performance by setting up two transceivers and testing Selective Calling and Encryption performance, if installed. We recommend that each transceiver be tested prior to delivery, so as to ensure proper functioning of the transceiver and its accessories in the controlled environment of your service shop.

ITU Channels

ITU No.	RX Freq.	TX Freq.	ITU No.	RX Freq.	TX Freq.	ITU No.	RX Freq.	TX Freq.	ITU No.	RX Freq.	TX Freq.	ITU No.	RX Freq.	TX Freq.	ITU No.	RX Freq.	TX Freq.	ITU No.	RX Freq.	TX Freq.	ITU No.	RX Freq.	TX Freq.	
401	4357	4065	801	8719	8195	1201	13077	12230	1601	17242	16360	1641	17362	16480	2201	22696	22000	2241	22816	22120	450	4125	4125	
402	4360	4068	802	8722	8198	1202	13080	12233	1602	17245	16363	1642	17365	16483	2202	22699	22003	2242	22819	22123	451	4146	4146	
403	4363	4071	803	8725	8201	1203	13083	12236	1603	17248	16366	1643	17368	16486	2203	22702	22006	2243	22822	22126	452	4149	4149	
404	4366	4074	804	8728	8204	1204	13086	12239	1604	17251	16369	1644	17371	16489	2204	22705	22009	2244	22825	22129	453	4417	4417	
405	4369	4077	805	8731	8207	1205	13089	12242	1605	17254	16372	1645	17374	16492	2205	22708	22012	2245	22828	22132				
406	4372	4080	806	8734	8210	1206	13092	12245	1606	17257	16375	1646	17377	16495	2206	22711	22015	2246	22831	22135	650	6215	6215	
407	4375	4083	807	8737	8213	1207	13095	12248	1607	17260	16378	1647	17380	16498	2207	22714	22018	2247	22834	22138	651	6224	6224	
408	4378	4086	808	8740	8216	1208	13098	12251	1608	17263	16381	1648	17383	16501	2208	22717	22021	2248	22837	22141	652	6227	6227	
409	4381	4089	809	8743	8219	1209	13101	12254	1609	17266	16384	1649	17386	16504	2209	22720	22024	2249	22840	22144	653	6230	6230	
410	4384	4092	810	8746	8222	1210	13104	12257	1610	17269	16387				2210	22723	22027	2250	22843	22147	654	6516	6516	
411	4387	4095	811	8749	8225	1211	13107	12260	1611	17272	16390					22726	22030							
412	4390	4098	812	8752	8228	1212	13110	12263	1612	17275	16393				2212	22729	22033				850	8291	8291	
413	4393	4101	813	8755	8231	1213	13113	12266	1613	17278	16396				2213	22732	22036				851	8294	8294	
414	4396	4104	814	8758	8234	1214	13116	12269	1614	17281	16399				2214	22735	22039				852	8297	8297	
415	4399	4107	815	8761	8237	1215	13119	12272	1615	17284	16402				2215	22738	22042							
416	4402	4110	816	8764	8240	1216	13122	12275	1616	17287	16405				2216	22741	22045				1250	12290	12290	
417	4405	4113	817	8767	8243	1217	13125	12278	1617	17290	16408				2217	22744	22048				1251	12353	12353	
418	4408	4116	818	8770	8246	1218	13128	12281	1618	17293	16411				2218	22747	22051				1252	12356	12356	
419	4411	4119	819	8773	8249	1219	13131	12284	1619	17296	16414				2219	22750	22054				1253	12359	12359	
420	4414	4122	820	8776	8252	1220	13134	12287	1620	17299	16417				2220	22753	22057							
421	4417	4125	821	8779	8255	1221	13137	12290	1621	17302	16420	1801	19755	18780	2221	22756	22060	2501	26145	25070	1650	16420	16420	
422	4420	4128	822	8782	8258	1222	13140	12293	1622	17305	16423	1802	19758	18783	2222	22759	22063	2502	26148	25073	1651	16528	16528	
423	4423	4131	823	8785	8261	1223	13143	12296	1623	17308	16426	1803	19761	18786	2223	22762	22066	2503	26151	25076	1652	16531	16531	
424	4426	4134	824	8788	8264	1224	13146	12299	1624	17311	16429	1804	19764	18789	2224	22765	22069	2504	26154	27079	1653	16534	16534	
425	4429	4137	825	8791	8267	1225	13149	12302	1625	17314	16432	1805	19767	18792	2225	22768	22072	2505	26157	25082	1654	16537	16537	
426	4432	4140	826	8794	8270	1226	13152	12305	1626	17317	16435	1806	19770	18795	2226	22771	22075	2506	26160	28085	1655	16540	16540	
427	4435	4143	827	8797	8273	1227	13155	12308	1627	17320	16438	1807	19773	18798	2227	22774	22078	2507	26163	25088	1656	16543	16543	
			828	8800	8276	1228	13158	12311	1628	17323	16441	1808	19776	18801	2228	22777	22081	2508	26166	25091	1657	16546	16546	
			829	8803	8279	1229	13161	12314	1629	17326	16444	1809	19779	18804	2229	22780	22084	2509	26169	29094				
			830	8806	8282	1230	13164	12317	1630	17329	16447	1810	19782	18807	2230	22783	22087	2510	26172	25097				
601	6501	6200	831	8809	8285	1231	13167	12320	1631	17332	16450	1811	19785	18810	2231	22786	22090				2251	22159	22159	
602	6504	6203	832	8812	8288	1232	13170	12323	1632	17335	16453	1812	19788	18813	2232	22789	22093				2252	22162	22162	
603	6507	6206				1233	13173	12326	1633	17338	16456	1813	19791	18816	2233	22792	22096				2253	22165	22165	
604	6510	6209				1234	13176	12329	1634	17341	16459	1814	19794	18819	2234	22795	22099				2254	22168	22168	
605	6513	6212				1235	13179	12332	1635	17344	16462	1815	19797	18822	2235	22798	22102							
606	6515	6215				1236	13182	12335	1636	17347	16465				2236	22801	22105							
607	6519	6218				1237	13185	12338	1637	17350	16468				2237	22804	22108							
608	6522	6221				1238	13188	12341	1638	17353	16471				2238	22807	22111				2258	22171	22171	
						1239	13191	12344	1639	17356	16474				2239	22810	22114							
						1240	13194	12347	1640	17359	16477				2240	22813	22117							
						1241	13197	12350																

V. Appendix

V-1. Computer Programming Using the CAT System

The CAT (Computer Aided Transceiver) System in the System 600 provides control of frequency, memory, and other settings using an external personal computer. This allows multiple control keystrokes to be fully automated as a single mouse click or keystroke operation on the computer keyboard. The CAT System protocols are available in the General Coverage and Amateur Radio configurations of the System 600.

The CAT System protocol is also utilized by the System 600 transceiver for the Cloning procedure.

To use computer control of your System 600 transceiver, the optional Yaesu FIF-232C Level-Conversion Interface Box is required. This device connects between the transceiver and computer, and converts the digital signal levels for proper data transfer. The cable for connection between the System 600 and the FIF-232C is supplied with the interface. A standard (not "null modem") serial cable will be required for connection of the FIF-232C to your computer's serial ("COM") port. Be sure that the serial cable has the proper gender and number of pins (some COM ports used a 9-pin rather than a 25-pin configuration). If the computer uses a custom connector, you may have to construct the serial cable; in this case, refer to the technical documentation

FIF-232C CAT System Interface Box



supplied with your computer for correct connections. The illustration at the bottom of this page shows an example of CAT system interconnections.

Yaesu Musen Co., Ltd. does not produce CAT System software, owing to the wide variety of personal computers and operating systems in use worldwide. However, the information presented in this chapter explains the serial data structure and opcodes used by the CAT system. This information, along with the brief programming examples supplied later, is intended to assist the developer in writing programs.

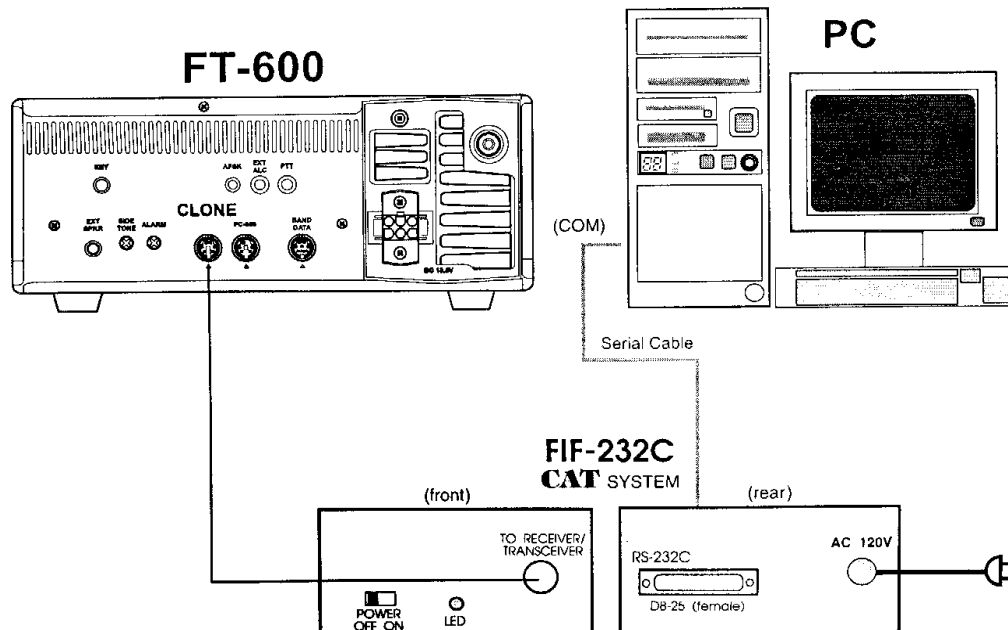

FT-600 Computer Interconnection with FIF-232C

Data Format

Serial data is passed at TTL levels (0 and 5V) via the **SO** (Serial Output) and **SI** (Serial Input) pins of the **CLONE** jack (pins 2 and 3, respectively) on the rear panel of the transceiver. The serial data format is 4800 bits/second; each byte sent consists of one start bit, 8 data bits, no parity, and *two* stop bits (4800,N,8,2).

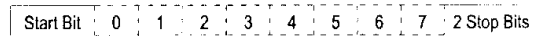

CAT Data (One byte, sent left-to-right)

All commands sent to the transceiver must consist of *blocks* of five bytes each, with up to 200 ms between each byte. The last byte sent in each block is the *instruction opcode*, while the first four bytes of each block are arguments: either parameters for that instruction, or dummy values (to pad the block out to five bytes).

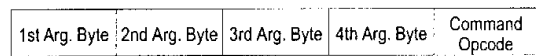

5-byte Command Block, sent left-to right

There are thirteen instruction opcodes for the System 600, listed in the table on the next page. Notice that several instructions require no specific parameters, but every command block sent to the transceiver *must* consist of five bytes.

The CAT control program in the computer must construct the five-byte block by selecting the appropriate instruction opcode, organizing the parameters, if any, and providing unused (dummy) argument bytes for padding (dummy bytes may have any value). The resulting five bytes are then sent, *opcode last*, to the **SI** (serial input) pin of the CAT jack on the rear of the transceiver.

Example: Tune to 14,250.0 MHz:

- First, determine the opcode for the desired instruction (see the CAT Commands table, next page). These opcodes should be stored in the program so they can be looked up when the user requests the corresponding command. In this case, the instruction is "Set Op Freq," so the opcode is 0Ah (small "h" letters follow-

ing each byte value indicate hexadecimal (base 16) values).

- Build the four argument byte values from the desired frequency by breaking it into 2-digit blocks (BCD "packed decimal" format). Note that a leading zero is always required in the "hundreds-of-MHz" place (and another in the "tens-of-MHz" place, if below 10 MHz).
- The resulting 5-byte block should look like this (again, in hexadecimal format):

Byte Value	0Ah	01h	42h	50h	00h
Content of this byte	Set Main VFO Freq. opcode	100's & 10's of MHz	1's of MHz & 100's of kHz	10's & 1's of kHz	100's & 10's of Hz

- Send these five bytes to the transceiver *in reverse order* from that shown above, i.e. from right-to-left; see the examples on page 35.

Data Returned From System 600

The *Status Update*, *Read Flags*, and *Read Meter* commands cause the System 600 to report various operational and internally-stored settings on the **SO** (serial output) line:

- Status Update* causes the System 600 to return all or portions of its RAM table (up to 1941 bytes).
- Read Flags* obtains only the first three bytes (the Status Flags) from the RAM table, plus two extra "filler" bytes (06h and 04h).
- Read Meter* returns the meter deflection (0 ~ 0FFh) repeated in four bytes, followed by one "filler" byte (0F7h).

Status Update Data Organization

The 1941 bytes of *Update* data are organized as shown at the top of the page after next. Aside from the *Read Flags* command, different portions of this data can be returned in blocks of 1, 18, 19, or 1941 bytes, depending on the parameters of the *Update* command sent by the computer. The details of these commands follow the descriptions of the data.

CAT Commands

Legend: Send all commands in REVERSE order from that shown! Commands that duplicate a front panel button are named with all caps. Parameter variables are named to reflect their format: eg., "CH" indicates a memory number, from 1 to 64h (1 to 100 decimal).

"—" indicates a padding byte. Value is unimportant, but it must be present to pad the block out to exactly five bytes.

Opcodes are listed in both hex and decimal format for convenience - only one opcode byte can be actually sent.

Command	Opcode		Parameter Bytes				Parameter Description
	hex	(dec)	1	2	3	4	
Recall Memory	02	2	CH	-	-	-	Recalls memory number CH: 1 to 64h corresponding to memories 1 through 100
Write VFO to Memory	03	3	CH	P2	-	-	Code display to memory CH (P2=0), Hide CH (P2=1) or Write CH (P2=0)
Recall VFO	05	5	-	-	-	-	Recalls the last-used VFO
Set Receive Freq.	0Ah	10	F1	F2	F3	F4	New operating frequency in F1 - F4, in BCD format: see text for example
Set Transmit Freq.	8Ah	138	F1	F2	F3	F4	New operating frequency in F1 - F4, in BCD format: see text for example
MODE	0Ch	12	M	-	-	-	M values: 0=A3J-LSB 1=A3J-USB 2=A1A-W 3=A1A-N 4=A3E-W 8=J2B-LSB-W 9=J2B-USB-W 0Eh=J2B-LSB-N 0Fh=J2B-USB-N
PTT	0Fh	15	T	-	-	-	Transmitter on (T=1) or off (T=0)
Status Update	10h	16	U	-	-	CH	Instructs the radio to return 1, 18, 19 or 1941 bytes of Status Update data. CH is significant only when U1=4. See text for U values.
Carrier Point	50h	80	W	S	F1	F2	Change the receiver carrier point. W=0 to write to memory, S=1 to set, F1 and F2 are (signed 2's complement) offset frequency in 10's of Hz, BCD encoded. Eg., for +1.5 kHz, F1=0 and F2=96h (150 dec); and for -1.5 kHz, F1=FF and F2=6Ah (FF6Ah = 65536 -150 dec).
VFO Rx→Tx	85h	133	-	-	-	-	Copy the current VFO receive frequency to the transmit frequency
Step Op Freq.	8Eh	142	D	-	-	-	Step operating freq up (D=0) or down (D=1) minimal step (10- or 100- Hz)
Read Meter	0F7h	247	-	-	-	-	Instructs radio to return digitized meter indication (4 repeated bytes, and 0F7h)
Read flags	0FAh	250	-	-	-	-	Instructs radio to return the 3 Status Flag bytes plus 06h and 04h constants (see following pages)

All 1941 Bytes of Status Update Data (Sent Left-to-Right)

Flags	M	Operating Data Record	Tx VFO Data	Rx VFO Data	100 19-Byte Memory Data Records
3	1	19 bytes	9 bytes	9 bytes	1900 bytes (100 x 19)
(A)	(B)	(C)	(D)	(E)	(F)

(A) Flag Bytes

The first three bytes are treated as 11 one-bit flag fields: a function is enabled (on) if a bit is set (1), and disabled (off) if reset (0). Most of the functions represented by these flags correspond to the radio display.

First Flag Byte

- Bit 0: LOCK is active (LOCK on LCD).
- Bits 1 ~ 4: Not used.
- Bit 5: Memory operation (MEM on LCD).
- Bit 6: Not used
- Bit 7: VFO operation (VFO on LCD).

Second Flag Byte

- Bit 0: PTT line closed by CAT command.
- Bit 1: Scanning or Dual Watch is "paused"
- Bit 2: Scanning or Dual Watch enabled
- Bit 3: J2B Filter: "Narrow" selected.
- Bit 4: A1A Filter: "Narrow" selected.
- Bit 5: J2B operation selected.
- Bits 6 & 7: Not used.

Third Flag Byte

- Bit 0: Not used.
- Bit 1: TX Output of 10W selected.
- Bit 2 ~ 4: Not used.
- Bit 5: Antenna tuner working (TUNING on LCD).
- Bit 6: Not used.
- Bit 7: Transmission in progress (PTT closed).

(B) Fourth Flag Byte

This byte is not used in the System 600.

(C) 19-Byte Data Record

A 19-byte record defining current operating conditions in the current VFO or memory. This record consists of one byte indicating the current memory channel number, followed by two 9-byte records indicating the current transmitter data and receiver data (described below) for either the VFO or Memory currently in use.

19-Byte Data Record Format

1-byte Mem number	9-byte Tx data (VFO or MEM – see below)	9-byte Rx data (VFO or MEM – see below)
-------------------	--	--

(D) & (E) Rx VFO and Tx VFO Data (9 bytes x 2)

After the 19-byte Data Record for *current* operation (either VFO or memory) is sent, two nine-byte VFO

Data Records are sent, one for the receive status and one for the transmit status. The format of each of these records is the same as described above and, in fact, when operating on a VFO, the values in these records are identical to the two nine-byte records in the 19-byte Data Record for current operation.

9-Byte VFO/Memory Data Record Format

Offset	Contents & Format
0	Band Data (BPF selection): 00h ~ 09h
1 ~ 3	Base frequency (without clarifier offset) in 10-Hz units (BCD) byte 1 = MSB, byte 3 = LSB 100 kHz (002710h) to 30 MHz (2DC6C0h)
4, 5	Not used
6	Mode: 00h = J3E(LSB), 01h = J3E(USB), 02h = A1A-W, 03h = A1A-N, 04h = A3E, 05h = J2B
7, 8	Not used

(F) 19-Byte Memory Data Records

After the two nine-byte records for the VFOs, 100 19-byte Data Records are sent, one for each memory, beginning with Memory Channel 1-01. Each Memory Data Record is constructed as described above for the other 19-byte Data Records. The Memory Channels are arranged in the following order:

- MB1 = 25 channels (01h~16h)
- MB2 = 25 channels (17h~32h)
- MB3 = 25 channels (33h~48h)
- MB4 = 25 channels (49h~64h),

where MB1~MB4 are Memory Banks 1~4.

Status Update Data Selection

The first and fourth parameters of the Status Update command allow selection of different portions of the Status Data to be returned as follows ("U" is the first parameter, "CH" is the fourth):

Parameters	Data Returned	Reference (see above)
U=0	All 1941 bytes	A
U=1	Memory Number	B
U=2	19-Byte Operating Data	C
U=3	18-Byte VFO-A Data	D & E
U=4, CH=1 ~ 64h	19-Byte Mem Data Record for memory no. CH	F

Note that, in most cases, you will only need to read the 19-byte Operating Data Record (with the first parameter = 2), since *all other CAT commands affect only this data*.

Read Flags Data

The *Read Flags* command retrieves the (first) three Flag Bytes of the Status Data. The transceiver responds to the *Read Flags* command by returning the Flag Bytes described on the preceding page, plus two bytes with the constant values of 06h and 04h (in that order), as shown here:

1st Flag Byte	2nd Flag Byte	3rd Flag Byte	Dummy (06h)	Dummy (04h)
---------------	---------------	---------------	-------------	-------------

Read Meter Data

Sending the *Read Meter* command causes the transceiver to return a digitized meter deflection between 0 and 0FFh. Four copies of this value are returned, along with one constant byte (0F7h), as follows:

Meter Byte	Meter Byte	Meter Byte	Meter Byte	0F7h
------------	------------	------------	------------	------

During reception, the signal strength deflection is returned. During transmission, the power output level deflection is returned.

Coding Examples

Although Yaesu Musen Co., Ltd. cannot offer to provide complete CAT control programs (owing to the wide variety of incompatible computers used by our customers), we present herewith a few examples of critical CAT i/o functions, in BASIC. Note that not all forms of BASIC may support some of the commands, in which case alternate algorithms may need to be developed in order to duplicate the functions of those shown.

Sending a Command

After "opening" the computer's serial port for 4800 baud, 8 data bits, two stop bits, and no parity as i/o device #2, any CAT command may be sent. The instruction opcode is sent last, with the first (MSB) parameter sent just before it, and the LSB parameter (or dummies) sent first. The parameters are sent in reverse order from that in which they appear in the "CAT Commands" table. Note also that, in the following examples, we are sending zeroes as dummy bytes, although this is not necessary. If you decide to send commands through a five-byte array, the values of the dummy parameters need not be cleared.

The following command could, for example, be used to set the frequency of the display to 14.250.0 Mhz:

```
PRINT #2,
CHR$(&h00);CHR$(&H50);CHR$(&H42);CHR$(&H01);
CHR$(&HA);
```

Notice here that the BCD values can be sent just by preceding the decimal digits with "&H" in this example. However, in an actual program, you may prefer to convert the decimal frequency variable in the program to an ASCII string, and then convert the string to characters through a lookup table.

If you send a parameter that is out of range for the intended function, or not among the specified legal values for that function, the System 600 should do nothing. Therefore, you may wish to alternate your sending of commands or command groups with a *Read Flags* or an *Update* command, allowing the transceiver to let the computer know if everything sent so far has been accepted and acted upon as expected.

Bear in mind that some commands specify "binary" (as opposed to BCD-formatted) parameters. You can send binary parameters without going through the character/hex string conversion process. For example, the CH parameter in the Command table is binary. You could have the System 600 recall Memory Channel 2-04 (which is interpreted as memory #29, since it is the fourth channel in the second bank of 25 memories) as follows:

```
PRINT #2, CHR$(0);CHR$(0);CHR$(0);CHR$(29);CHR$(2);
```

Reading Returned Data

The reading process is easily done through a loop, storing incoming data into an array, which can then be processed after all expected bytes have been read into the array. To read the meter:

```
FOR I=1 TO 5
  MDATA(I)=ASC(INPUT$(1,#2))
NEXT I
```







Recall from above that the meter data consists of four identical bytes, followed by a filler byte, so we really only need to see one byte to get all of the information this command offers. Nevertheless, we must read all five bytes (or 1, 18, 19, or 1941, in the case of the Update data). After reading all of the data, we can select the bytes of interest to us from the array (MDATA, in the above example).

V-2. Memory Backup and System 600 Switch-On Options

The System 600's memory system uses a non-volatile RAM chip, instead of a lithium or other battery-based backup system. No operator intervention should be required in order to maintain the integrity of memory information indefinitely.

Several switch-on options exist on the System 600. These may be useful for testing the display or clearing all memories, if desired (and if possible on your transceiver version). To perform the switch-on function, turn the transceiver off, then push *and hold in* the appropriate key or keys (see below) while you turn the transceiver on. Once the display stabilizes, you may release all keys.

Switch-On Options

Command	Push following key(s) while turning System 600 on	Comments
All Reset	 + 	Not Land Mobile/Marine
Display Check	 + 	Checks all display segments
Beep On/Off		Front panel beeper on/off
J2B Mode		Toggles J2B mode LSB/USB
Reset Tuner Memories		When using FC-800

V-3: General Coverage Operation



This section will provide stand-alone instructions for operation of the System 600 in a Governmental or other General-Coverage application (such as the U.S. Civil Air Patrol or Military Affiliate Radio System). Release of this information to a user not duly authorized to operate this equipment in a General Coverage manner is expressly prohibited by Yaesu.

Yaesu System 600 HF Transceiver Operation

Startup Procedures

- Be certain that all power supply, antenna, ground, microphone, and other accessory connections have been properly accomplished.
- Preset the I/O (power) switch to OFF, and rotate the volume and squelch controls fully counter-clockwise.
- Now apply DC power to the System 600 by plugging in and turning on the AC Power Supply, if operating from a base station, or turning on the vehicle, if mobile.
- Next, turn on the transceiver by pushing in the I/O switch. The LCD display will become illuminated; the current channel frequency or Alpha Tag, the operating mode, and/or the channel number will be displayed. If you are on an ITU Marine channel, in transceivers so configured, the ITU icon will also be displayed.

Reception

- Advance the volume control for a comfortable listening level on the incoming signals or noise present on the speaker or headphones. 
- When no signal is present on the channel, rotate the squelch control clockwise until the background noise is just silenced. Unless you are responsible for listening for very weak signals (very near the background noise level), silencing the receiver using the squelch circuitry is usually preferable in many applications. 

When a signal strong enough to override the squelch threshold is received, the incoming signal will be heard in the speaker or headphones, and the **BUSY** icon will become illuminated. When the incoming transmission is complete, the **BUSY** icon will disappear, although the **RX** icon will still be illuminated.

- When a signal is being received, the Bar Graph will become illuminated according to the strength of the incoming signal. You may use this Bar Graph to compare communications path effectiveness on different channels, or to assist with optimum antenna rotation, if a directional antenna is being used.

S
PO **2** **4** **6** **8** **10**

- Should you encounter impulse noise, such as that from a vehicle's ignition system or a power line, push the keypad's **2** (Noise Blanker) switch, which should help reduce the noise level.

- If the station you are listening to should drift or otherwise be unclear (the voice may sound too high-pitched or too bassy), rotating the Clarifier control may improve the sound of the incoming signal. Rotating the Clarifier control does *not* affect your *transmission* frequency; only the *receive* frequency is being adjusted. Note that the frequency change caused by the Clarifier control does not affect the displayed frequency. Accurate (receive) frequency readout only occurs when the Clarifier control is set to the 12 o'clock position. 

- Should you encounter interference in the A1A or J2B operating modes, reception may be improved by activating a narrower filter (if installed). Push **F** then **MODE 1** to view the current filter (**WIDE** is the default). Rotate the Main Dial to display **NARROW**, then push **MODE 1** again to resume normal operation.

F → **MODE 1** → **WIDE** → turn Main Dial → **NARROW** → **MODE 1**

If, however, your transceiver has *not* been fitted with a narrow filter, activating the **NARROW** mode may actually *degrade* reception. If such a filter has not been installed in your transceiver, leave the filter selection on its default **WIDE** setting.

- If the Main Display is too bright, push the **ON 0** key on the keypad. This will reduce display brightness by about 50%.
- To turn the internal speaker (or external speaker, if used) *off*, push the **OFF 7** key on the keypad. Repeat this procedure to restore speaker audio. *Note: this action does not affect audio output delivered to the headphones or the rear panel AFSK receive audio jack.*
- To turn the front panel keypad "beep" tone generator off, turn the transceiver off. Now, push and hold in the **ON 8** key while you turn the transceiver on. No tone will be emitted from the speaker when any front panel key is pushed. To re-activate the beeper, repeat the above procedure.

I/O + **ON 8**

Frequency and Channel Selection

The System 600 HF Transceiver includes the following frequency selection capabilities:

- A VFO (Variable Frequency Oscillator—free tuning) system;
- Four user-programmable memory banks for storage and recall of any frequency (simplex or split transmit/receive frequencies) within the range of the transceiver;

- A dedicated memory bank storing ITU-defined Marine channels in transceivers configured for Marine use; and
- A one-touch Emergency Channel Memory, which places the transceiver on 2.182 MHz (in transceivers configured for Marine use).

In the VFO mode, the frequency is displayed on the left side, with the mode icon being found against the far left edge of the display. On the right side of the display, the current synthesizer step size (default: 100 Hz/step) is displayed.



In the Memory mode, on the right side of the display a hyphenated number is shown (for example, 4-25). The digit to the *left* of the hyphen is the *Memory Bank* number, while the digits to the *right* are the *channel numbers* within that bank. Therefore, in the above example, the display is indicating Channel #25 on Memory Bank #4.

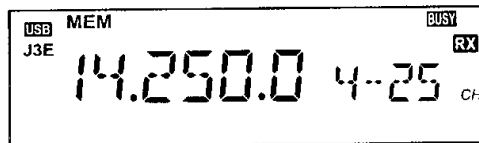

In the ITU mode, the frequency and operating mode are displayed as they are during VFO operation; however, the right side of the display indicates the ITU Marine Channel designator.

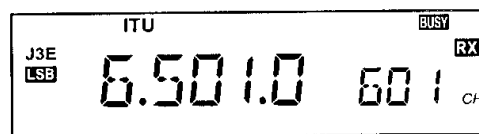

Frequency and channel selection are very simple on the System 600:

- Select the desired frequency selection technique (VFO, ITU, etc.) by repeatedly pushing the front panel **M** key. The circulation of frequency selection modes is VFO → Memory Bank 1 → Memory Bank 2 → Memory Bank 3 → Memory Bank 4 → ITU → VFO .

VFO → **MEM** (Bank 1) → **MEM** (Bank 2) →
MEM (Bank 3) → **MEM** (Bank 4) →
ITU → **VFO** ...

- Once the desired channel grouping is selected, channel or frequency selection may be performed.

- In the VFO mode, rotate the Main Dial to tune in the desired station.

- In the Memory mode, rotate the Main Dial to select the desired channel within the selected Memory Bank. Remember that there are a total of four such Memory Banks, so if you do not find a particular channel it may have been stored in a different Memory Bank. Push the **M** key to select a different Memory bank, then rotate the Main Dial to select the available channels in the Memory Bank.

- In the ITU mode, rotate the Main Dial to change channel numbers within the standard ITU Marine Channel bank provided. Operating mode is automatically selected, and cannot be changed in the ITU bank.

- The microphone **UP** or **DWN** buttons may also be used to select frequencies or channels. Pushing the **UP** or **DWN** button *momentarily* will cause the frequency or channel to increment or decrement one step, respectively.

Pushing *and holding* the **UP** or **DWN** button for longer than 0.5 second will cause the frequency or channel selection to *scan* upward or downward manually. Releasing the **UP** or **DWN** button halts the scan.

- In the VFO mode, frequency selection may also be made via direct keypad entry.

For Simplex Channels (transmission and reception on same frequency):

- Press the **M** key, as needed, to select the VFO mode.

- Press the **MODE** **1** key, as needed, to select the desired operating mode (A1A, A3E, etc.).

- Push the **ENT** key momentarily, then enter six digits of the desired operating frequency (the 10s of Hz digit cannot be entered, even if 10 Hz steps are selected—this is a time-saving feature).

- Push *and hold in* the **ENT** key for 0.5 second when all six digits have been entered. This will switch the transceiver to the new frequency. If you need to change operating modes, see below.

For Semi-Duplex Channels (different transmit/receive frequencies):

- Press the **M** key, as needed, to select the VFO mode.

- Press the **MODE 1** key, as needed, to select the desired operating mode). Note that this must be the same on the transmit and receive frequencies.
- Push the **ENT** key momentarily, then enter six digits of the *receive* frequency, as above.
- Push the **ENT** key momentarily *again*, and now enter six digits of the *transmit* frequency.

Now press *and hold in* the **ENT** key for 0.5 second to lock in the split frequency pair. You may confirm that the transmit frequency is different by pushing the PTT switch on the microphone; the displayed frequency will change if the split pair have been successfully entered.

- In the VFO mode, the operating mode may be changed by the operator. By repeatedly pressing the keypad's **MODE 1** switch, you may select from the available operating modes: J3E (USB), J3E (LSB), J2B (LSB default), A1A (CW), and A3E (AM).
- In the VFO mode, if the tuning rate is too slow or too fast, the frequency synthesizer steps may be changed by the operator. Available step sizes are:

- 10 Hz/step (500 Hz per dial rotation)
- 100 Hz/step (5 kHz per dial rotation)
- 1 kHz/step (50 kHz per dial rotation)

Fine tuning steps will be best for modes like A1A, where tuning is critical. The larger tuning steps may be more suitable for modes like AM (A3E), where precise tuning often is not essential.

- In the Memory Mode, an "Alpha Tag" label may have been added at the time of programming, so as to aid in identification of the memory. To see if an Alpha Tag has been added to a particular memory channel's data, press the **MEM 6** key on the keypad. If no data was included, the channel *frequency* information will simply go blank, leaving only the channel number on the display. If an Alpha Tag *was* stored during programming, the Alpha Tag will *replace* the channel frequency information on the display.

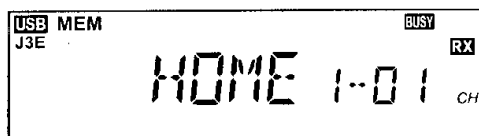

2182 Emergency Channel Mode

A special Emergency Channel feature of the System 600 provides several important operational benefits, if the transceiver has been configured for Marine use.

- Pressing the **2182** key automatically switches the transceiver to the Marine Distress Channel, 2182 kHz (2.182 MHz), and also places the transceiver in the

H3E (Single-Sideband AM) mode. On the display, the frequency "2.182.0" will be displayed, as well as a special Alpha Tag **E-CH**, designating this as the Emergency Channel. If desired, the mode may be changed to J3E (USB) by pressing the **MODE 1** key on the keypad.

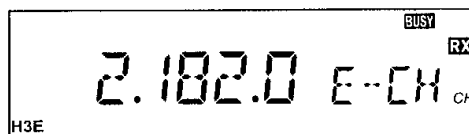

- The **ALARM** key, adjacent to the **2182** key, may be used for sending a distress call. To *test* the alarm, just push the **ALARM** key momentarily. After one second, an audible alarm will be heard, although no transmission will occur. You may use this Alarm Test mode to adjust the level of the rear panel **ALARM** potentiometer. Press the **ALARM** key again to end the test.

In an emergency, press the ALARM key, hold it in, and press the 2182 key while holding ALARM in. This will transmit the international marine distress signal (alternating 1300 Hz and 2200 Hz tones) for 35 seconds. Press ALARM (not 2182) to cancel the transmitted distress signal.

Be certain your operators and crew understand the function of the 2182 Alarm feature, and make sure they understand that it is only to be used in case of a true emergency situation.

Front Panel Locking

To prevent inadvertent changing of the channel frequency or other front panel parameters, press the **LOCK** switch on the front panel. All keys will then be locked out of operational command capability except for the **2182**, **ALARM**, and the **LOCK** switch itself. Press the **LOCK** switch again to release the front panel to normal operation.

Memory Channel Storage

Four Memory Banks, each capable of storing up to 25 memory channels, are provided, yielding a total of 100 available memory channels. Programming is easily accomplished using the keypad.

For Simplex Memory Channels (transmit and receive on same frequency):

- Press the **M** key, as needed, to select the desired Memory Bank.
- Once the desired Memory Bank is selected, rotate the Main Dial to select the desired Memory Channel within that bank. If you choose a channel on which

data is already stored, you will *overwrite* the data previously stored.

- Press the **MW** (Memory Write) key momentarily, then enter six digits of the desired operating frequency (the 10's of Hz digit cannot be entered, as frequency resolution during memory operation is to the nearest 100-Hz step).
- Press the **ENT** key. The **TX** icon will blink. If the displayed frequency is the same as the *receive* frequency just stored, press the **ENT** key again (see the note following "Semi-Duplex Channels" below).
- Now press the **MODE 1** key, as needed, to select the desired operating mode.
- Now press *and hold in* the **ENT** key for 0.5 second to lock the frequency and mode into memory.
- Repeat this procedure for all memory channels desired. Note that Memory Channel 1-01 is used for "Dual Watch" operation (explained later), so it is advised that you not use this channel except for the Dual Watch Priority Channel.
- To *delete* channel information from a memory, follow the above procedure for *storage*, but enter all *Zeros* for the frequency (e.g., 000000), then press **ENT**. The memory data for that channel will then be erased.

If you make a mistake during memory entry, rotate the Main Dial so as to cause the erroneous digit of the frequency to blink; now, push the *correct* number on the keypad, and continue with the remainder of the memory frequency entry process.

For Semi-Duplex Channels (different transmit/receive frequencies):

- Press the **M** key, as needed, to select the desired Memory Bank.
- Once the desired Memory Bank is selected, rotate the Main Dial to select the desired Memory Channel within that bank. If you choose a channel on which data is already stored, you will *overwrite* the data previously stored.
- Press the **MW** (Memory Write) key momentarily. The **RX** icon will blink, indicating that you are setting the *receive* frequency. Now enter all six digits of the desired receive frequency (the 10s of Hz digit cannot be entered, as frequency resolution during memory operation is to the nearest 100 Hz step).
- Press the **ENT** key momentarily. The **TX** icon will blink, indicating that you are now setting the *transmit* frequency.
- Now enter all six digits of the desired transmit frequency.
- Press the **ENT** key momentarily.
- The mode icon will now be blinking. Press the **MODE 1** key, as needed, to select the desired operating mode.
- Now press *and hold in* the **ENT** key for 0.5 second to lock the split frequency pair into memory.

Note Regarding Memory Programming

If you have programmed a split pair of frequencies into a memory, remember that both the receive and transmit frequencies must be entered if you over-write that memory slot, even if it is a "simplex" situation. Just re-enter the receive frequency when the TX icon is blinking, as described previously, to ensure that storage of an unwanted split frequency pair does not occur.

Alpha Tag Programming

An Alpha-Numeric label, referred to as an "Alpha Tag" in this manual, may be added to the contents of a memory location. Such an "Alpha Tag" may be easier or more intuitive for the operator to utilize when recalling memories; frequency information alone can be especially confusing when a large number of memories are stored.

Storage of an Alpha Tag into a memory location is simple to perform. Use the following procedure:

- Select the Memory Bank and Memory Channel number on which you desire to add an Alpha Tag.
- Press the **AT** key to select the Alpha Tag method of memory channel display. If an Alpha Tag has been previously stored, it will be displayed now. If *no* Alpha Tag has been stored, only the memory channel number will be displayed (e.g. 1-05). You may want to double-check the frequency data at this point, to be certain you have selected the correct channel.
- Press the **ENT** key to enter the Alpha Tag Entry mode. The first digit location on the left side of the display will begin blinking.
- Select the first character of the proposed Alpha Tag by rotating the Main Dial.
- When the first digit has been chosen, press the **ENT** key. The second digit of the Alpha Tag will now blink.
- Repeat the entry procedure of rotating the Main Dial to select the desired character, then pressing the **ENT** key, for up to six digits of the Alpha Tag.

- To complete the entry and return to normal operation, push *and hold in* the **[ENT]** key for 0.5 second. This may be done at any point in the Alpha Tag Entry process.

If you make a mistake, just re-write the Alpha Tag from the beginning.

Useful tips: the “**u**” character is used to program a *blank space*, which may be useful on some Alpha Tags. Also, use the “Zero” figure when an upper-case “O” (“Oh”) is desired, as the “O” figure in the Alpha Tag character set is *lower case* (o).

Transmission

- For Voice transmission, close the **PTT** (Push To Talk) switch on the microphone; the transmitter will now be activated (note that the **TX** icon has become illuminated on the Main Display). Hold the microphone about 25 mm (1 inch) from your mouth, and speak into the front of the microphone in a normal voice level. No adjustment of the microphone gain level should be necessary; this level has already been set by at the factory. Release the **PTT** switch on the microphone to return to the receive mode (the **RX** icon will again become illuminated, and the **TX** icon will go out).
- For CW (Morse Code telegraphy) in the A1A mode, begin sending using your telegraph key or electronic keyer. The System 600 will automatically be placed in the transmit mode (**TX**) when you start to send, and will revert to the receive mode (**RX**) when you stop sending.

As you send, a “Sidetone” audio generator allows you to monitor your sending. The level of this Sidetone may be adjusted through the small **SIDETONE** hole on the rear panel of the transceiver.

- For Data transmission (including Morse Code telegraphy) using a TNC (Terminal Node Controller) and keyboard, or similar computer-driven data transmission devices, transmit/receive control is exercised by the software which accompanies the data transmission equipment in use. See the User’s Manual for your terminal equipment for operating instructions.

Important Note for First Time Users!

If your installation includes the FC-800 External Antenna Tuner, and you are using new channels or a new antenna system for the first time, you may have to perform a simple antenna “tuning” procedure before proceeding with normal operation. See the “Antenna Tuning Procedures” section below for details.

Note Regarding Data Operation

The FT-600’s J2B (AFSK) mode utilizes **LSB** (Lower Side Band) for its default operating mode. Some services, however, utilize **USB** (Upper Side Band) for digital work. Changing the J2B operating mode is a protected, yet operator-accessible, procedure, accomplished as follows:

- Turn the transceiver off.
- Press and hold in the **[MODE 1]** key while turning the transceiver on.

The **LSB** mode should be displayed.

- Rotate the Main Dial so that **USB** is displayed.
- Press **[MODE 1]** again to store your new setting, and resume normal operation.

Remember to follow the maximum power output guidelines during continuous-duty operation such as RTTY (Radio TeleType) in the J2B mode. Adjust the TX Audio level from the TNC for a maximum of 50 watts power output (five segments illuminated on the Power Output Bar Graph) if long periods of continuous transmission are anticipated.

Antenna Tuning Procedures

When the Yaesu FC-800 External Antenna Tuner is installed, it must be activated on each channel in use. Otherwise, the necessary tuner settings will not be stored, and little power output will occur.

While transmitting, you should see the bargraph illuminate fully to the right side (to the **[70]** icon). If this does not happen, the antenna system may require retuning. Use the following procedure.

- Be certain that all connections to the FC-800 have been properly made.
- With the appropriate channel selected via the Main Dial, press the **[TUNER 3]** key on the keypad. The **TUNER** icon on the Main Display will blink, and the System 600 will transmit for a short time. Thereafter, the trans-

Note Regarding FC-800 Antenna Tuner Operation

If you are testing the FC-800 prior to final installation, you will notice that it emits a “chattering” sound during antenna tuning. This is perfectly normal, as tuning is accomplished by the high-speed switching of mechanical relays at low power levels.

ceiver will return to the receive mode, and the **TUNER** icon will now be illuminated constantly.

- Once the Antenna Tuner is activated on a particular channel or channels, it will remain active unless you turn it off by pushing the **TUNER** key again. If this is done, and an improperly-tuned antenna is connected to the rear panel Antenna jack, the power output from the transceiver will be suppressed by the power amplifier protection circuitry.
- As a short-cut to tuning each antenna individually, you may use a special procedure for tuning *all* channels stored in Memory Bank 1 (Memory Channels 1-01 through 1-25). Push the **(F)** key, then (within five seconds) push the **TUNER** key. The Main Display will indicate **TUNING** and the transmitter will be activated. When tuning of all channels on Memory Bank 1 is completed, the transceiver will revert to the receive mode. Note that this Automatic Memory Bank Tuning feature may take up to three minutes to complete. During this time, no transceiver operations may take place. Do not turn the transceiver off during Automatic Memory Bank Antenna Tuning.
- The FC-800's microprocessor-based circuitry includes memory sufficient to retain 31 antenna tuning settings in memory. This will greatly reduce frequency change time. If you utilize more than 31 operating channels that are widely removed in frequency, the new tuning settings will be over-written (repeatedly) onto tuner memory slot #31.

Important Note!

*If the FC-800 is unable to attain a satisfactory impedance match to your antenna, tuning will cease and the **TUNER** icon will cease to be illuminated. Under these conditions, you will have to change the antenna's length or otherwise modify your antenna for proper performance. See the FC-800 Operating Manual your dealer or installer for further advice.*

Shortwave Listening

When tuning through the HF bands, the System 600 serves as a high-performance shortwave monitor receiver. The optional YF-112A 6-kHz AM filter may provide better fidelity on shortwave broadcasts, and it is highly recommended if you do any extended AM listening.

Any displayed frequency may, of course, be stored in a memory (as described on page 40), so you can recall it quickly later. Once you become familiar with the memories, you will find them extremely helpful in recalling favorite stations quickly.

Popular Shortwave Broadcast Bands

Meter Band	Freq. (MHz)	Meter Band	Freq. (MHz)
LW	.150~.285	31	9.35~9.90
MW	.520~1.625	25	11.55~12.05
120	2.30~2.50	22	13.60~13.90
90	3.20~3.40	19	15.10~15.70
75	3.90~4.00	16	17.55~17.90
60	4.75~5.20	-	18.90~19.30
49	5.85~6.20	13	21.45~21.85
41	7.10~7.50	11	25.67~26.10

Weatherfax Monitoring

Monitoring of HF WeatherFax broadcasts is easily accomplished using the System 600.

- Before proceeding, be certain that the WeatherFax demodulator unit is properly connected to the System 600 transceiver.
- Set the Mode to J3E (USB), by pushing the **MODE** key as needed.
- Set the transceiver to the VFO mode (unless a WeatherFax channel has been programmed into a Memory channel). Now, using the keypad (or Main Dial, in the Memory mode), select the operating frequency of the station transmitting the WeatherFax broadcast. Note that, in the USB mode, the frequency you should program onto the display is typically 1.90 kHz *below* the station's "assigned" frequency. Thus, for a WeatherFax station assigned to 8.682.0 MHz, tune to 8.680.1 MHz.
- When the WeatherFax broadcast begins, no further operator intervention should be needed from the transceiver standpoint. The audio level from the AFSK jack on the rear of the transceiver is fixed, and cannot be adjusted. Fine adjustments in the grey-scale and the frame adjustment are all accomplished using the

computer connected to your WeatherFax demodulator.

Dual Watch

The System 600 Dual Watch feature allows the user or dispatcher to operate on one channel while periodically making a brief check of Memory Channel 1-01 (Memory Bank #1, Channel #1). The Dual Watch feature is enabled so long as there is frequency and mode data written into Memory Channel 1-01.

Every five seconds, the transceiver will automatically switch over—for two seconds—to Memory Channel 1-01. If a station is transmitting on Memory Channel 1-01, one of two things will happen:

- If the System 600 is in the “Carrier Drop” mode, the transceiver will hold on Memory Channel 1-01 until the transmission ceases. The transceiver will continue to hold for five seconds after the transmission ends, in case the other station decides to resume transmitting. After the five second delay, Dual Watch will resume, with your original operating channel (not Memory Channel 1-01) being restored to the Main Display.
- If the System is set to the “Time Delay” mode, the transceiver will hold on Memory Channel 1-01 for ten seconds, then Dual Watch operation will resume (irrespective of the transmit/receive status of any stations on Memory Channel 1-01). Note that, after ten seconds of “holding” on Memory Channel 1-01, the transceiver will *revert* to your original frequency for five seconds, checking *that frequency* for renewed activity. After the five seconds of checking the original frequency are completed, the transceiver will re-check Memory Channel 1-01, and will again hold there for ten seconds if the squelch is “open.”

Dual Watch operation is simple to use:

First, set the desired “Resume” mode for Dual Watch. Usually, this will be “Carrier Drop,” which will not allow the transceiver to move off Memory Channel 1-01 if someone is still transmitting.

- To do this, push (F) then (8), and rotate the Main Dial until [RRR] is shown. If you prefer the “Time Delay” mode, rotate the Main Dial until [TTE] is displayed. Now push (8) again to return to the normal display.
- Adjust the squelch control so that the [BUSY] icon disappears and the receiver is silenced.
- Push (8) to activate Dual Watch. After five seconds, the transceiver will switch over to Memory Channel 1-01, and will stay there for two seconds, thereafter returning to your original channel.

- If a call is received on Memory Channel 1-01 during Dual Watch operation, the transceiver will lock onto that channel, then resume in accordance with the “Resume” mode selected previously.
- Push (8) again to de-activate Dual Watch. Operation will revert to your original operating frequency.

Note that your main operating channel can be changed during Dual Watch operation, but you cannot change channels while Memory Channel 1-01 is being checked for activity. Dual Watch can also be activated in the “2182” mode.

SELCALL (Selective Calling) Operation (J3E Mode Only)

- To activate the SELCALL system, push the front panel S button momentarily. The (incoming) R# I# selective calling code will be displayed. This is the code that your station should have been assigned by the dispatch center when your network was set up. If the R# I# code is correct, push *and hold* in the S button for 0.5 second to place the transceiver in the SELCALL receiving mode. (If the code is *not* correct, see below.)

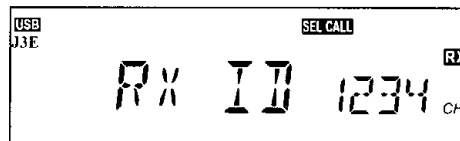

- In the SELCALL receiving mode, the receiver will be muted, and the [SEL CALL] icon will be illuminated. When a call to your R# I# code is received, a bell alarm will be heard and the [SEL CALL] icon will blink. Push the PTT switch momentarily to cancel SELCALL, then push the PTT and speak into the microphone in the usual fashion to reply to the SELCALL page.
 - Once you have transmitted following reception of a SELCALL page, SELCALL must be *re-activated* by the operator; otherwise, normal receive (un-muted) operation will occur. Push the S key twice, as above, to re-activate SELCALL operation.
 - The volume level of the receive SELCALL alarm bell may be adjusted via the rear panel [SIDETONE] potentiometer.
- If you have programmed a *transmit* SELCALL page code (any of T# I# 1 through T# I# 5), the transmit SELCALL signal may be sent via the following procedure:
- Press the S button to display the R# I# code.

- Rotate the Main Dial to select the desired TX ID code for the station(s) you wish to page.
 - Press the **S** button for 0.5 second to transmit the page. Do *not* close the PTT switch; pushing the **S** key will automatically engage the transmitter. To repeat the page, push **S** once *momentarily* and then again push **S** for 0.5 second.
 - To revert to the *receive* SELCALL mode, push **S** (the TX ID code will be displayed), then rotate the Main Dial to display the RX ID code. Now push *and hold* in the **S** key for 0.5 second to re-enable receive SELCALL operation.
- To *change* the SELCALL codes in your transceiver, use the following procedure:
- Turn the transceiver Off.
 - Push *and hold* in the **S** key while you turn the transceiver On. The display will show **R# I** followed by four digits (or four hyphens, if this is the first time a receive SELCALL code is being programmed).
 - Press the keypad's **ENT** key momentarily. The first digit location of the RX ID code will blink. Now key in a four-digit ID code (Note: you may not use the "0" (Zero) figure for *any* digit in a receive SELCALL code). Complete the procedure by pressing *and holding in for 0.5 second* the **ENT** key after all four digits have been entered. The display will revert to the operating frequency.
 - If you intend to program a transmit SELCALL code, proceed to the next paragraph. If you are *not* programming a transmit SELCALL code, turn the transceiver Off, then back On, to resume normal operation.
 - To program a *transmit* SELCALL code, push the **S** key momentarily. The RX ID code will appear. Now rotate the Main Dial clockwise one click to display **T# I**, the first of five different transmit SELCALL codes available. As on receive, press the keypad's **ENT** key momentarily; the first digit of the TX ID code will blink. Enter the four-digit code of the station you wish to page, then press and hold in the **ENT** key for 0.5 second.

The **0** (Zero) key is available when programming transmit ID SELCALL codes; it activates a "Group Page" mode. Placing the "0" figure as the *first* digit in a TX ID code will cause *all* units to be paged whose *next three digits are the same as the last three digits of the dispatcher's TX ID code*. For example, if the dispatcher sends a TX ID code of "0555," then any fleet units with "x555" in the RX ID code (e.g. "1555," "2555," etc.) will be paged. If the dispatcher sends a TX ID code of "5055," then any fleet units with "5x55" in the RX ID

code (e.g. "5155," "5255," etc.) will be paged. If *all zeroes* are sent as a TX ID code by the dispatcher, then *all* stations will be paged.

Do not use "0" as a "routine" digit in a TX ID code, since the "0" cannot be entered as an RX ID code by another unit; the use of the "0" figure is reserved for Group Paging.

- Rotate the Main Dial one click clockwise to display TX ID 2, and you may repeat this procedure for up to five TX ID SELCALL codes. If your fleet regularly utilizes SELCALL, it may be a good idea to store "0000" as a universal fleet paging code in one TX ID memory, so as to allow paging of all units by the dispatcher.
- When all SELCALL codes are stored in memory, turn the transceiver Off, then On again, to resume normal operation.

Note that the TX ID codes may be changed at any time by pressing the **S** key momentarily, rotating the Main Dial to display the desired TX ID code, and completing the above entry procedure. The **RX ID** code, however, can only be changed by first switching the transceiver Off, then pushing the **S** key and holding it in while turning the transceiver On. This is a safety feature designed to help prevent inadvertent changing of the important receive SELCALL identification code.

Encrypted Transmission/Reception (requires FVP-24 Module)

- If the transceiver you are using (and others in your communication group) is equipped with the FVP-24 Encryption Module, the Encryption mode may be activated on any *J3E* channel by pressing the front panel **E** key. The **ENCRP** icon will become illuminated.
- To transmit, push the PTT switch, and speak into the microphone per normal procedure. You may find that communications quality is slightly degraded during Encrypted operation; this is normal.
- If the signals of all the other stations in your communications group have a *severely* distorted or "scrambled" sound, you may have accidentally de-activated your transceiver's encryption mode. Pushing the **E** key may allow recovery. However, if only *one* station in your communications group sounds distorted or "scrambled," it is possible that the encryption mode of *that* transceiver may have been accidentally turned off. Either the dispatcher or you may advise the other station by switching *your* encryption off and calling the other station in the non-encrypted mode. **Remember that your transmissions will be sent in a non-encrypted format, and will thus not be secure; limit your**

*discussion to a brief advisory regarding the **E** switch on the other station's transceiver, then revert to encrypted operation immediately by pressing the **E** key on your transceiver.*

To de-activate encryption, push the **E** key again.

Notes Regarding Encrypted Operation

Successful operation in the "Encrypted" mode requires that the frequencies of the communicating stations be closely matched (± 50 Hz). The installation of the TCXO-4 is highly recommended for reliable operation in the Encrypted mode.

*If your transceivers are **not** equipped with the TCXO-4, use the following procedure to align your communications link:*

- First establish communications in the non-encrypted mode, and adjust your operating frequency using the clarifier so that the voice quality is as natural as possible.*
- Now press the **E** key to enable the Encryption mode, and begin secure communication.*

Note also that communication using encryption typically requires a signal-to-noise ratio of at least 10 dB. Under marginal signal conditions or high noise, encrypted communication may be impossible.

YAESU

...leading the way.SM

Copyright 1996
Yaesu Musen Co., Ltd.
All rights reserved.

No portion of this manual
may be reproduced without
the permission of
Yaesu Musen Co., Ltd.

Printed in Japan



E 0 6 0 4 1 5 0 1

0005c-GY